

## QUEEN

### ASSEMBLY INSTRUCTIONS

Before assembling your bed frame, please read through these instructions carefully and familiarize yourself with the different parts.







**ATTENTION!** If you receive a damaged or defective item, please contact afifurnishings at customerservice@afifurnishings.com or 1-800-955-3726

#### PARTS LIST

- ① **SIDE RAILS**                    **2 PCS**
- ② **SLAT KIT**                        **2 SET**
- ③ **SUPPORT RAIL**                **2 PCS**
- ④ **SUPPORT LEGS**                **4 PCS**

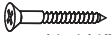
#### HARDWARE

- A**  JCB M6 X 30mm ( 1 1/8" ) - 6 pcs  
Spare - 1 pc
- B**  Cap Nut - 6 pcs
- C**  JCB M8 X 40mm ( 1 5/8" ) - 4 pcs  
Spare - 1 pc
- D**  Wood screw(1 1/4" ) - 12 pcs  
Spare - 1 pc
- E**  Allen wrench M4 - 1pc  
Spare - 1pc
- F**  Allen wrench M6 - 1pc

NOTE: WE INCLUDE SPARE HARDWARE IN CASE DAMAGE OCCURS DURING ASSEMBLY.

#### Step 1

Attach side rails (1) to the headboard and footboard. For assembly, follow the assembly instructions included with your headboard and footboard.

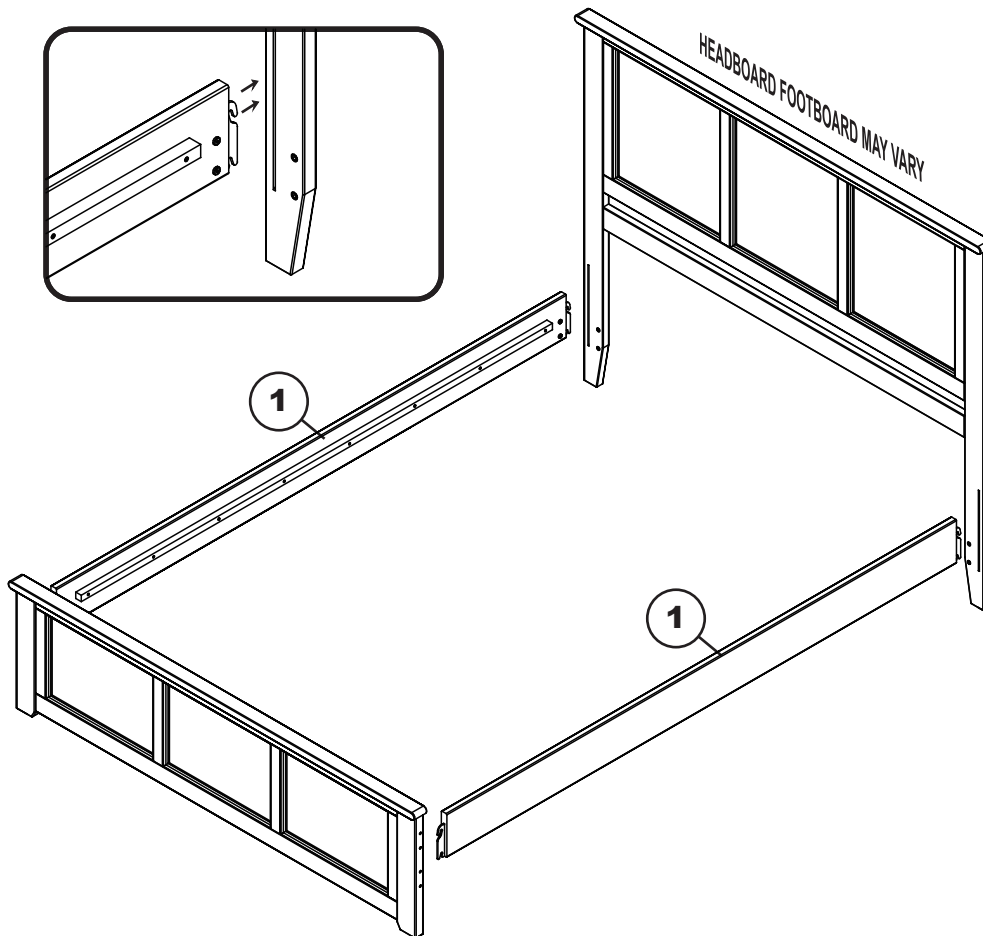
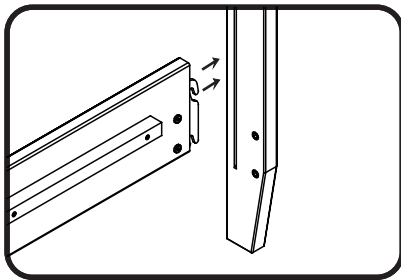

**PO:**

**CODE**                    **ITEM**  
FR-KEW-LOM            R-22224X

# QUEEN

## Step 3

Attach support legs (4) to support rail (3) as shown below. Using JCB M8 (C) tighten with Allen wrench M6 (F). Repeat the other.

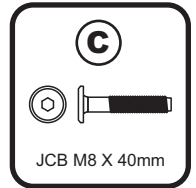
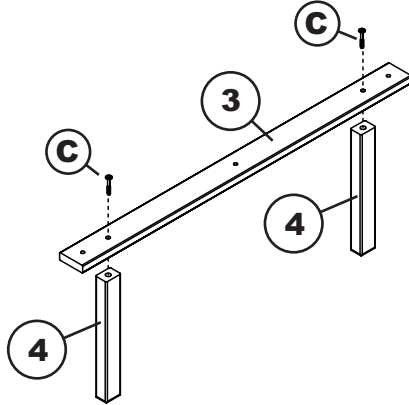

## Step 4

Attach support rail (3) to the slat kit (2) as shown below. Using JCB M6 X 30mm (A) and cap nut (B). Tighten with Allen wrench M4 (E). Using wood screw (D) tighten with Phillips head screwdriver. (Customer supplied)

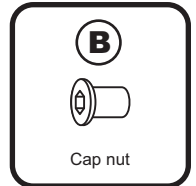
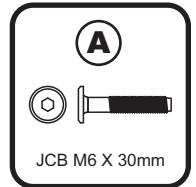
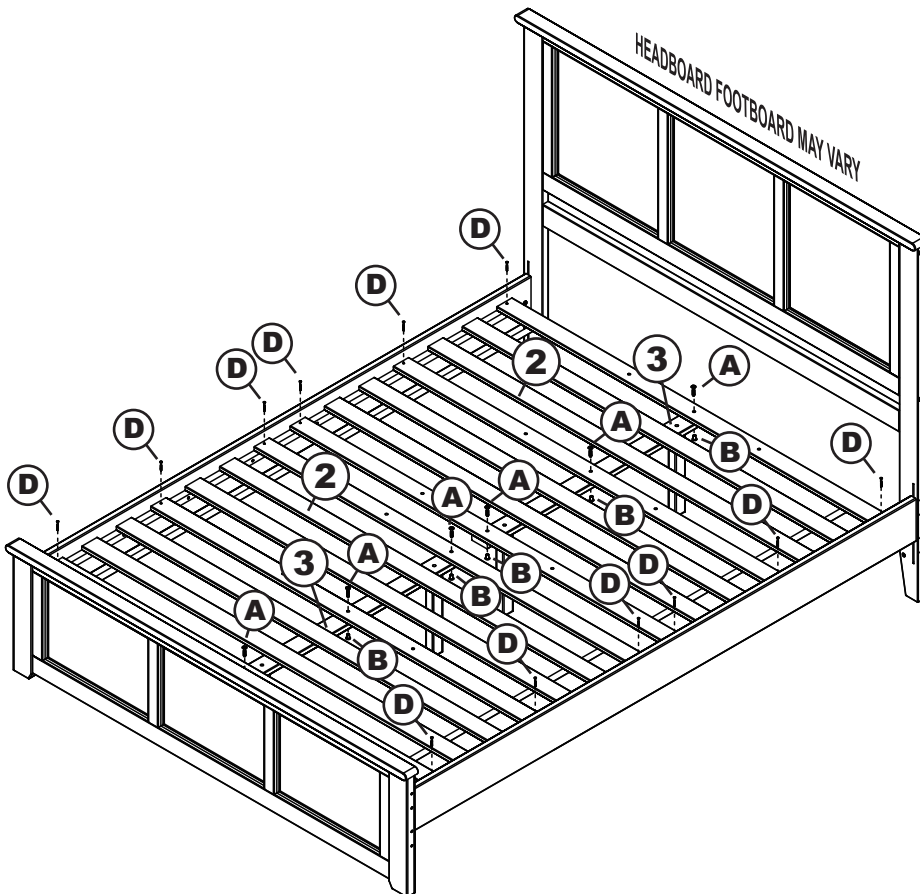

**Congratulations!**

Your bed is now ready for use.

We recommend that you periodically recheck that all screws are tight to ensure lasting safety.

## ASSEMBLY INSTRUCTIONS

Before assembling your headboard, please read through these instructions carefully and familiarize yourself with the different parts.

**ATTENTION!** If you receive a damaged or defective item, please contact afifurnishings at [customerservice@afifurnishings.com](mailto:customerservice@afifurnishings.com) or 1-800-955-3726



### PARTS LIST

- 1 HEADBOARD PANEL 1 PC
- 2 LEFT LEG 1 PC
- 3 RIGHT LEG 1 PC
- 4 SPACER BLOCK 2 PCS
- 5 PACKING STICK 2 PCS
- 6 FOOTBOARD 1 PC

Instructions apply for bed sizes  
TWIN > FULL > QUEEN

### HARDWARE

- |  |  |  |
|--|--|--|
| (A) Wooden dowel - 4 pcs<br>Spare - 1 pc           | (D) Wood screw - 4 pcs<br>Spare - 1 pc         | <b>HARDWARE FOR METAL BED FRAME</b>      |
| (B) JCB M6 X 70mm (2 3/4") - 4 pcs<br>Spare - 1 pc | (E) JCB M6 X 25mm (1") - 4 pcs<br>Spare - 1 pc | (F) Flat washer - 4 pcs<br>Spare - 1 pc  |
| (C) Barrel nut - 4 pcs<br>Spare - 1 pc             | (H) Allen wrench - 1 pc<br>Spare - 1 pc        | (G) Split washer - 4 pcs<br>Spare - 1 pc |

NOTE: WE INCLUDE SPARE HARDWARE IN CASE DAMAGE OCCURS DURING ASSEMBLY.

### Step 1

Remove packing stick (5) from headboard panel (1) and **DISCARD**. Insert wooden dowels (A) to the locator holes on spacer block (4). Attach the spacer blocks (4) to the legs (2) and (3), using wood screws (D), as shown below. Tighten with Phillips screwdriver. (customer supplied)

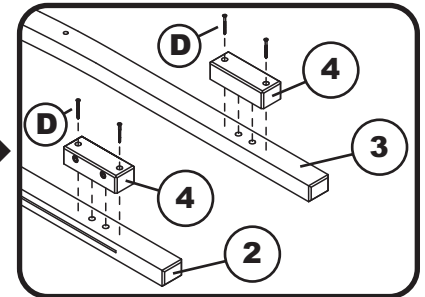
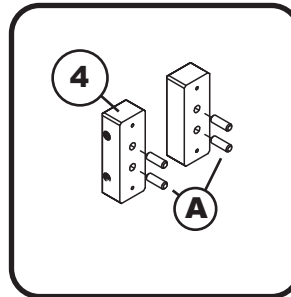
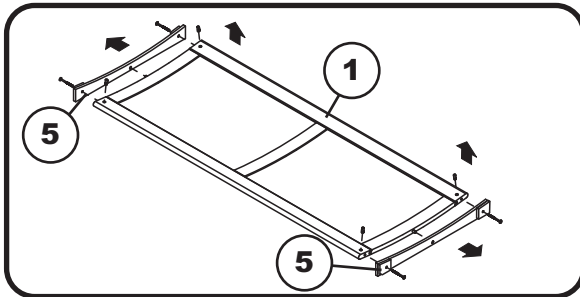

### Step 2

Attach the legs (2) and (3) to the headboard panel (1), using JCB (B) and barrel nut (C). Tighten with the Allen wrench (H).

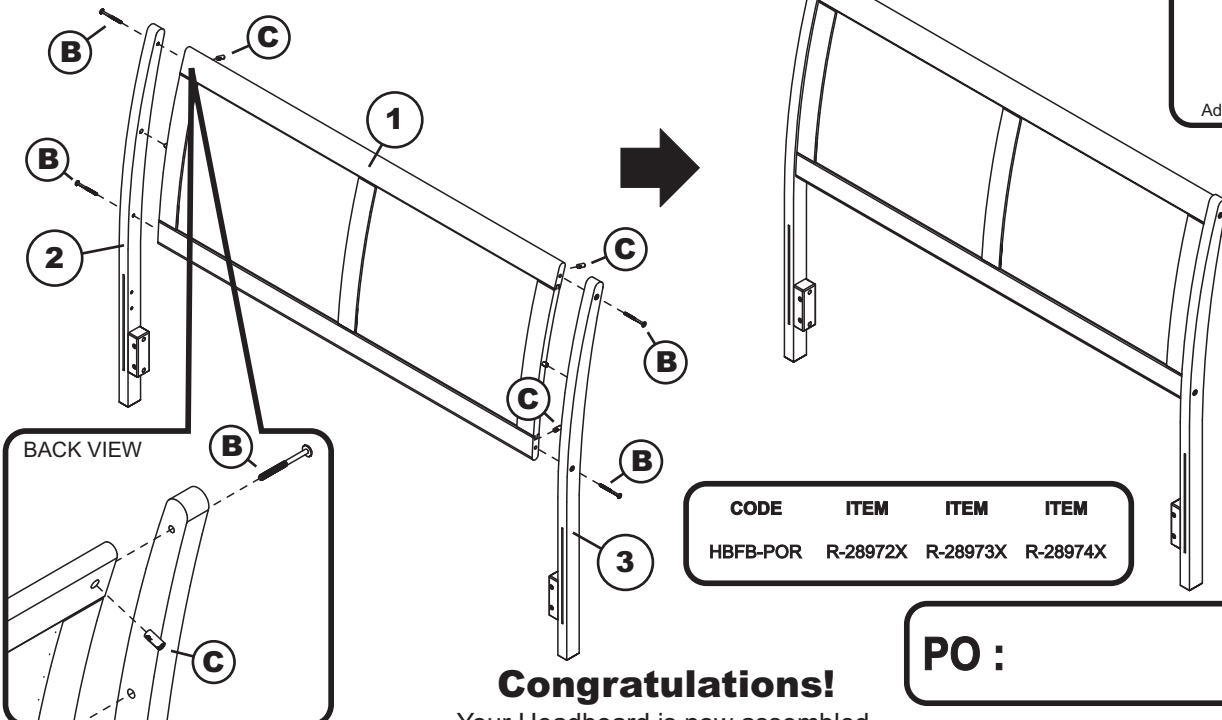

CODE	ITEM	ITEM	ITEM
HBFB-POR	R-28972X	R-28973X	R-28974X

PO :

**Congratulations!**

Your Headboard is now assembled.

To ensure lasting safety, we recommend that you periodically check that all screws are tight and all parts are secure.

- 01 HARDWARE
  - 02 HEADBOARD
  - 03 FOOTBOARD
  - 04 SIDE RAILS
- BOX 1
- BOX 2



**Step 1** Attach the side rails (04) to the headboard (02) and footboard (03) using the bed hook as shown below.

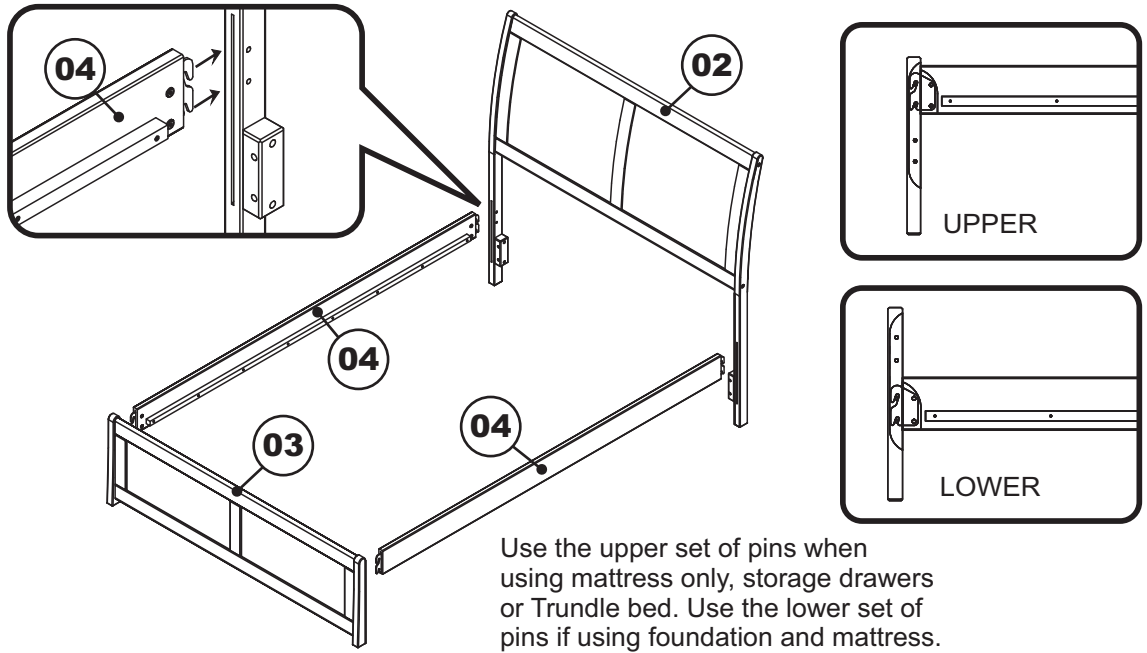

**Step 2** Lastly, lay slat kit or foundation support board onto the bed. For assembly, follow the assembly instructions included with support system.

PLATFORM BED - TALL HEIGHT



TRADITIONAL BED - LOW HEIGHT

