



MAGNETIC GAMING CHAIR

MODEL RTA-TS68C

ASSEMBLY INSTRUCTIONS

REV.ZK-1-8125-0524











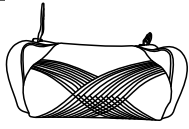

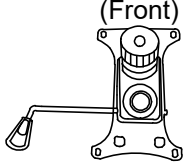

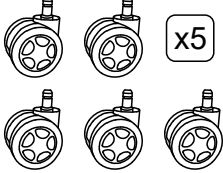
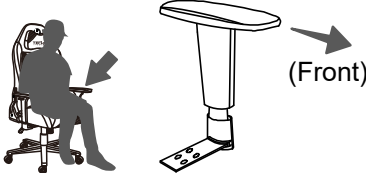
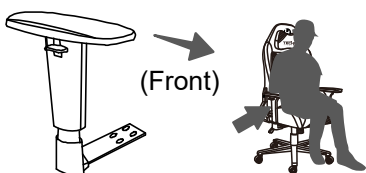
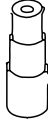
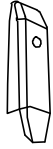
Thank you for purchasing our product

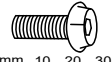
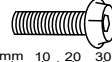

<p>Do a quick inventory of all the parts and hardware listed below.</p> 	<p>For Support, assembly questions & Replacement Parts within the 48 Contiguous United States:</p> <p>Please email us at: support@technisportusa.com</p> 	<p>Replacement Parts for International Customers & AK-HI-PR orders: RTA Products will replace the part free of charge, while the customer is responsible for shipping costs plus any International local taxes or duties.</p>
---	---	--



MAIN PARTS LIST

A Backrest 	B Seat  <div style="background-color: #333; color: white; padding: 2px; font-size: 0.8em;">* Read notes below about brackets</div>	C 5-Leg star base 	D Mechanism 	E Lift cylinder 	
F Casters 	G-L Left armrest 	G-R Right armrest 	H Covers for lift cylinder x1 Set 		
I-L Left cover 	I-R Right cover 	J Magnetic head pillow 	<p style="text-align: center; margin: 0;">IMPORTANT NOTE</p> <p style="margin: 0;">* The LEFT bracket on the seat is LOOSE, while the RIGHT bracket is STIFF, so DO NOT attempt to move the RIGHT bracket, as it requires a lot of force that can be achieved ONLY when the chair is FULLY ASSEMBLED.</p>		

HARDWARE LIST			
Part #	QTY	SIZE/Description	Item
K	4	M8x20	 <small>mm 10 20 30 40 50 60</small>
L	12	M8x25	 <small>mm 10 20 30 40 50 60</small>
M	2	M5x12	 <small>mm 10 20 30 40 50 60</small>
N	16	Ø12, Ø9 O-Rings	 <small>mm 10 20 30 40 50 60</small>
O	16	Ø9, Ø17, 1mm Washers	 <small>mm 10 20 30 40 50 60</small>
P	4	Ø14, Ø11, 5mm Armrest caps	 <small>mm 10 20 30 40 50 60</small>
Q	4	Ø9, Ø25, 2mm Felt gaskets	 <small>mm 10 20 30 40 50 60</small>

INCLUDED TOOLS	
M5 Allen Wrench	

IMPORTANT NOTES

- Do not discard this manual or any of the packaging material until the unit is completely assembled. 
- Read the assembly instructions thoroughly and follow them step by step.  
- Make sure to use the correct size of screws on the correct holes and do not overtighten to avoid the screws to strip, break, or get stuck inside the holes.



ASSEMBLY STEPS

STEP 1

- K (x4)(M8x20)
N (x4)
O (x4)
Q (x4)
M5

FIRST: Place Q over the indicated holes on B, and D over Q with the knob towards the front.

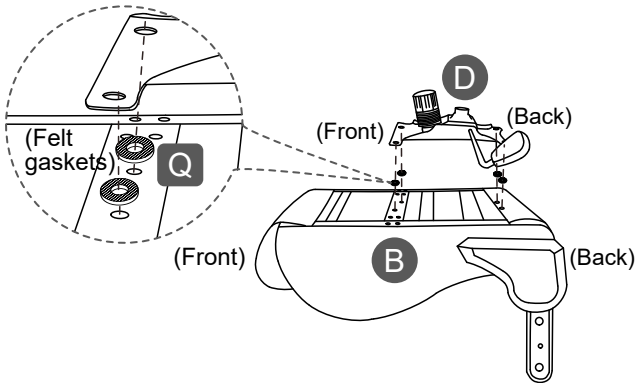

THEN: Secure D to B with K, N and O, with N in the middle.

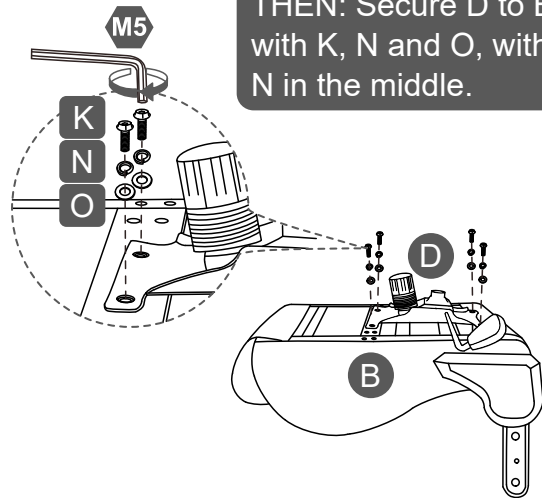

STEP 2

- L (x8)(M8x25)
N (x8)
O (x8)
M5

Assemble G-L and G-R to B in their respective sides with L, N and O.

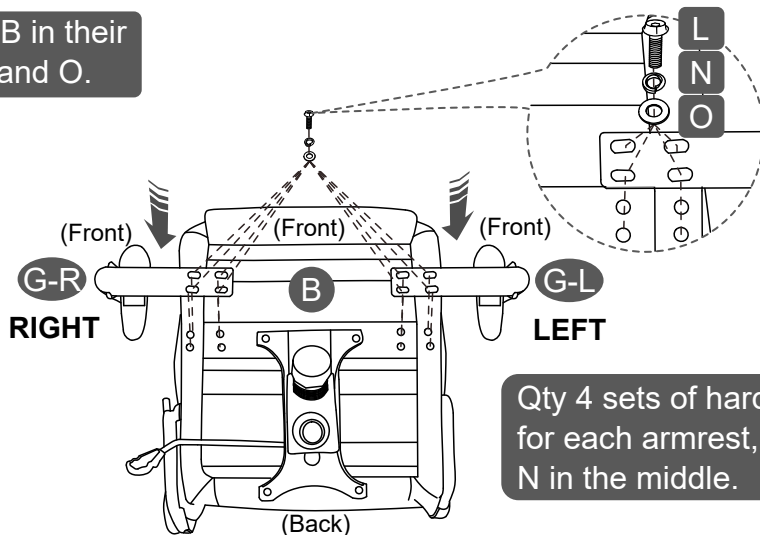
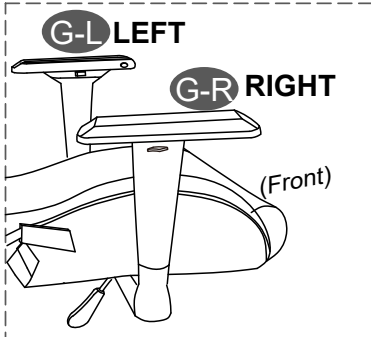

Qty 4 sets of hardware for each armrest, with N in the middle.

STEP 3

FIRST: Attach F to C using pressure.

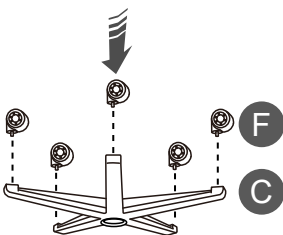

THEN: Insert E in the middle of C and cover it with H.

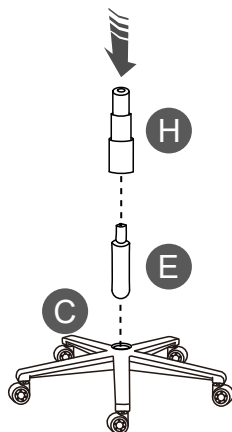

LAST: Join the seat to the base, making sure E enters correctly into D.

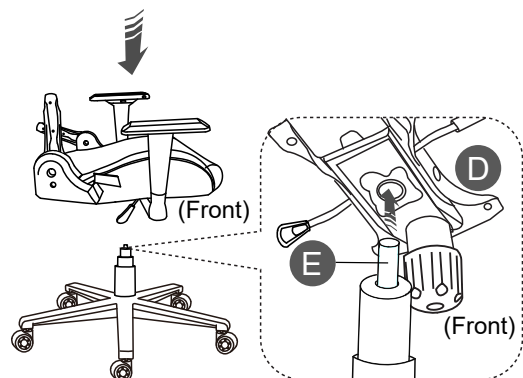

STEP 2 L (x4)(M8x25) N (x4) O (x4) M5

FIRST: Join A to B, matching the holes on the metal brackets.

THEN: Assemble A to B with L, N and O, with N in the middle.

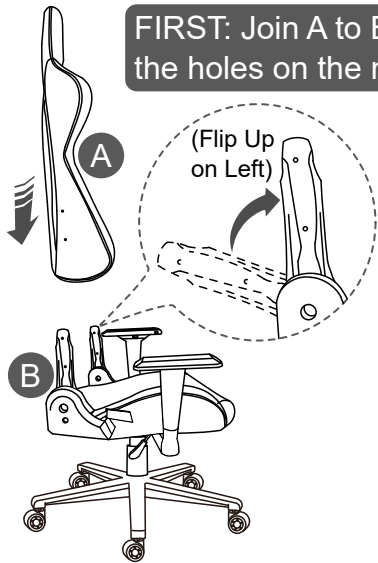

Qty 2 sets of hardware on each side, with N in the middle.

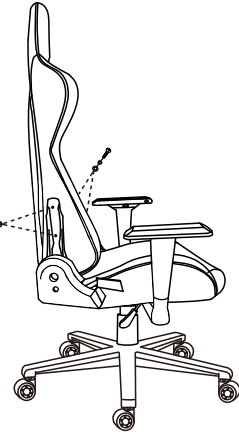
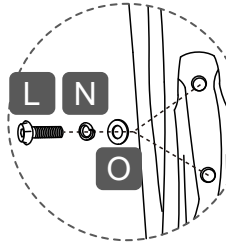

STEP 5 M (x2)(M5x12) M5

Attach the covers I-L, I-R to the metal brackets of B in their respective sides with M.

Remember: Right or Left side is with you sitting on the chair, not looking at it.



STEP 6 P (x4)

FIRST: Cover the holes on the sides with P.

THEN: Attach the Magnetic Pillow J to A.

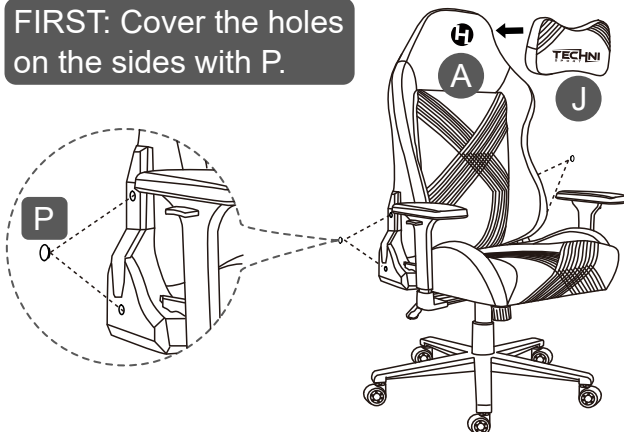

J **MAGNETIC MEMORY FOAM HEAD PILLOW.**
 The magnets in the pillow can interfere with implanted medical devices such as pacemakers. We recommend to consult with your physician on whether you would need to keep some distance between your medical implant and the pillow. You can also use the chair without the pillow.

CHAIR'S FUNCTIONS

Pull Handle UP.

⚠ WARNING!
Never recline with the tilting UNLOCKED.

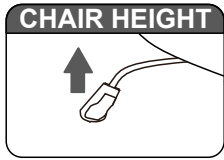
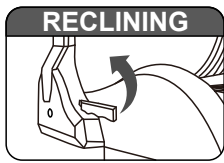

Pull Handle UP.

Pull Handle OUT to UNLOCK;
Push Handle IN to LOCK.

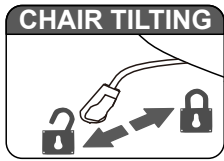

Note: Gaming chairs have the tilting point off-center and further back, therefore, the tilting might feel hard or minimal.

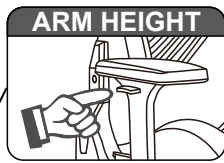
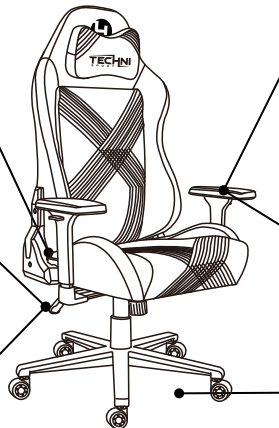

Press Button.

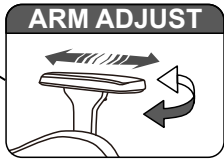

Slide the armrests BACK-FORTH;
Pivot SIDE-TO-SIDE.

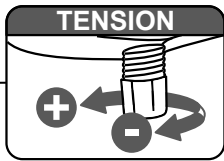

Turn CLOCKWISE for less tension (-);
COUNTERCLOCKWISE for more tension (+).
With less tension, the tilting feels easier.

WARNINGS

Not paying attention to the following warnings could result in injuries.



Do not use the chair if the frame parts are damaged, or if any of the screws are loose or missing.



Only one person at a time and refrain from sitting on the edge of the seat to prevent the chair from tipping over.

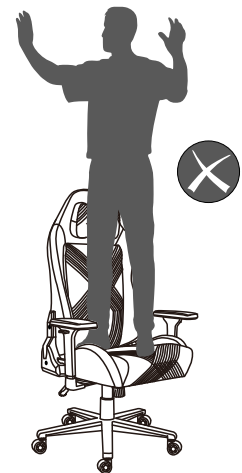

Do not stand or use the chair as ladder.

WEIGHT LIMIT



DO NOT EXCEED



Do not leave babies or toddlers unattended while seated on the chair, always ensure adult supervision. Keep children from playing with the chair for their safety.

CARE AND MAINTENANCE

Clean using a soft cloth dampened in a solution of water and mild soap.



Do not use solvents or abrasive materials.



Do not expose to direct sunlight or extreme environmental conditions.

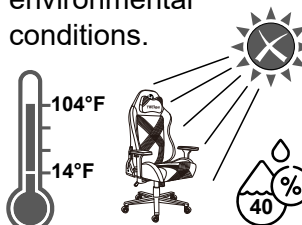

Inspect every 4 months and make sure that all screws are tightened.

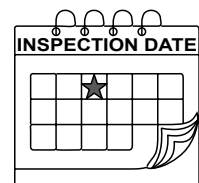

TECHNI SPORT WARRANTY



Gaming Chair: 2-YEAR WARRANTY

Gaming Chair Internal Metal Frame*: LIFETIME WARRANTY

RTA Products, LLC has warranted the Techni Sport products to the original purchaser who acquired a new product from RTA Products or its authorized re-sellers of the product against defects in material or workmanship.

This warranty is expressly limited to the repair or replacement (at its option) of defective product components or materials as a result of a defect in materials or workmanship. This warranty is limited to merchandise purchased in the Continental United States, excludes AK, HI and PR. No assembly labor is included. The word "defects" as used in this warranty, is defined as imperfections that impair the utility of the product.

This warranty applies under conditions of normal use, but does not apply to defects that result from intentional damage, wear & tear, negligence, unreasonable use or exposure.

Internal metal frame*: Refers to the internal metal steel structure of the seat and back only.

Liability for consequential damages is excluded to the extent exclusion is permitted by law. This warranty gives you specific legal rights, and you may have other rights that vary from State to State.

RTA Products does not warrant: a) natural variations in character marks b) changes in surface finishes due to aging or exposure to light c) marks, scars, or wrinkles occurring naturally in leather d) failure resulting from normal wear and tear e) the matching of colors, grains, or textures of natural materials f) the colorfastness or the matching of textiles, including an exact match to cuttings or to swatch cards g) damage, marking, or staining of veneer surfaces due to contact with rubber or similar compounds, damage from sharp objects or imprinting from writing instruments, or prolonged exposure to direct sunlight h) we do not warrant products that are exposed to extreme environmental conditions or that have been subject to improper storage.

RTA Products shall not be liable for loss of time, inconvenience, commercial loss, or incidental or consequential damages.

Any modification to the original product voids the warranty. We do not warrant the performance of the product when used in combination with other than original products.

This product has been designed for and is intended for office, home-office and gaming use only. This warranty is Original Purchaser's sole remedy for product defects, and this warranty does not extend to any product, or damage to any product, caused by or attributed to abuse or misuse, products used for commercial or rental purposes, use modifications of, or attachments to the product, and products or parts not used, maintained, or extended here under is in lieu of any and all other warranties, express or implied, including without limitations any implied warranty or merchant ability or of fitness for a particular purpose.

To file a Claim within the 48 contiguous United States: Email us to warranty@rtaproducts.com to explain the defect and provide your name, address, phone number, model number of our product, date and place, and proof of purchase. Please provide pictures of the damage or defect.

If we determine that a replacement will remedy the situation, and in order to determine the extent or the cause of the defect, purchaser may be requested to send the part in question at purchaser's expense. Once we receive the part, we will examine it and determine whether the claim is valid (or not), and then proceed to send the replacement. We will ship the replacement at our expense.

Replacement Parts for International Customers & AK-HI-PR orders: RTA Products will replace the part free of charge, while the customer is responsible for shipping costs plus any International local taxes or duties.