

Assembly Guidance

Note: The location of holes might be different from image as we are improving our products constantly

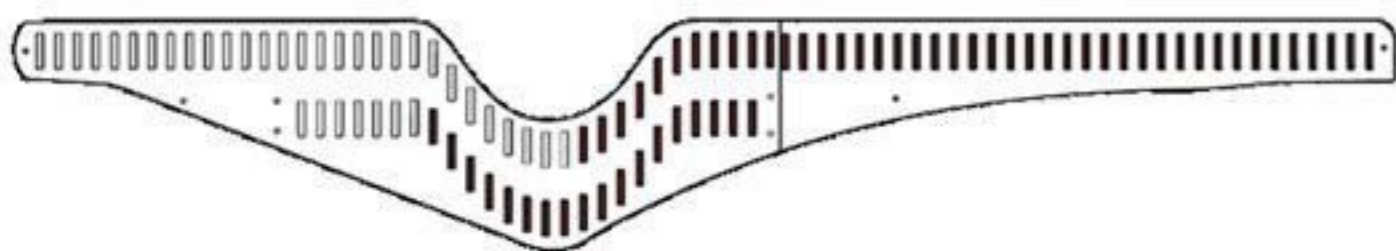

Each piece is identical. There are some numbers on the pieces but don't mind it, it is some crafting problem but these numbers are not gonna be seen. So you can start to assemble by selecting pieces randomly as each part is uniform.

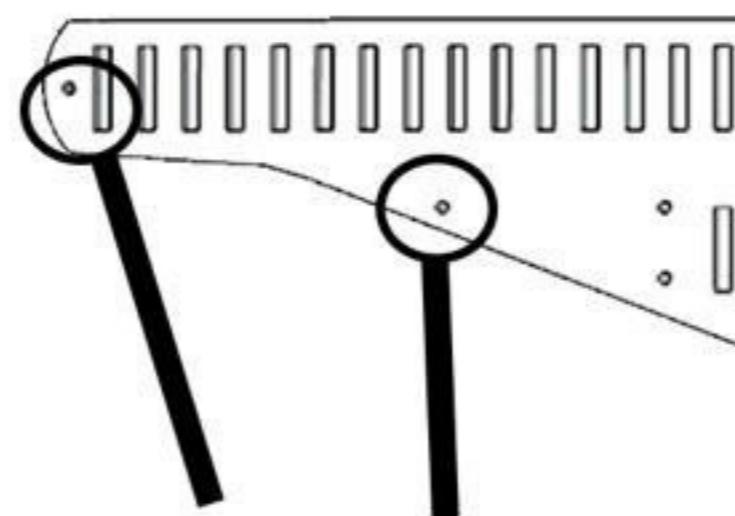

"Reference holes"

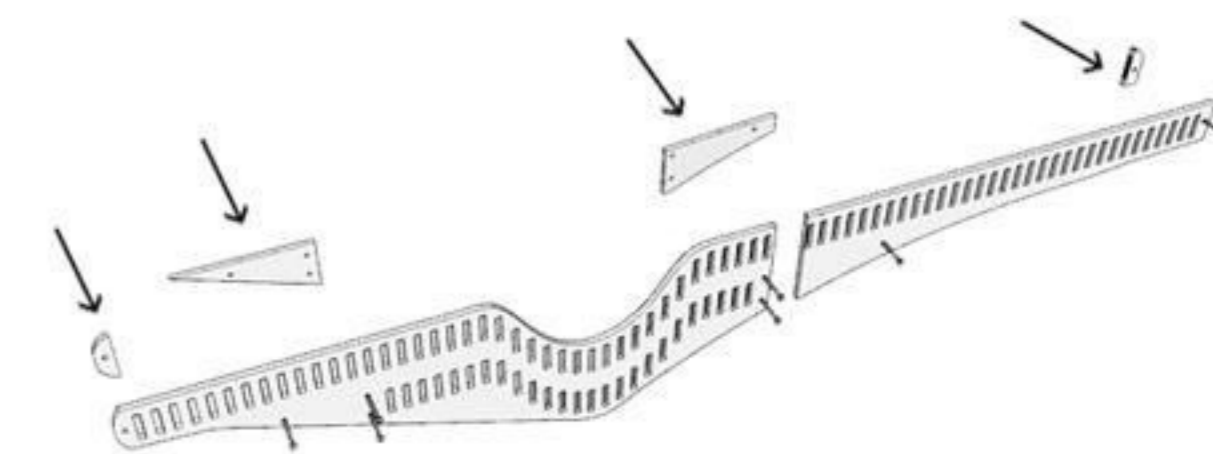

Then, as shown in the diagram, mount the pieces that will create a gap between the base and the wall onto the base using screws.

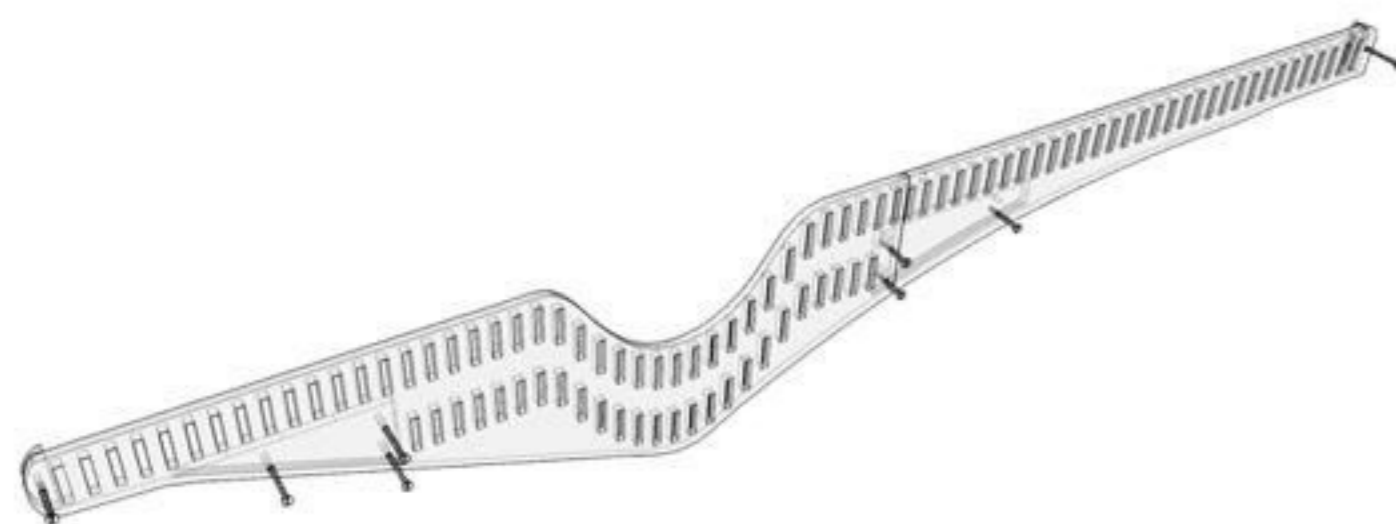

Turn the screws only enough to connect the base with the attachments.

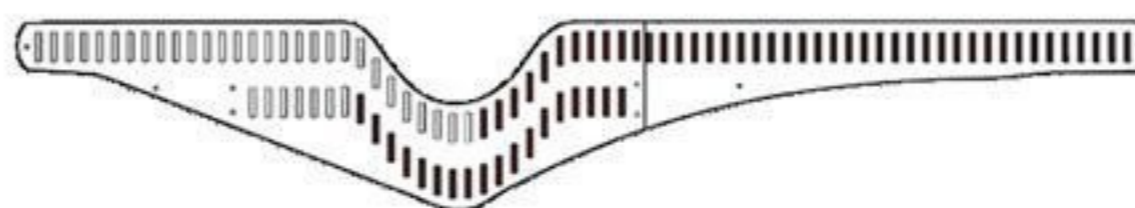

~~Mount the shelf base onto the wall dowels that were previously installed.~~

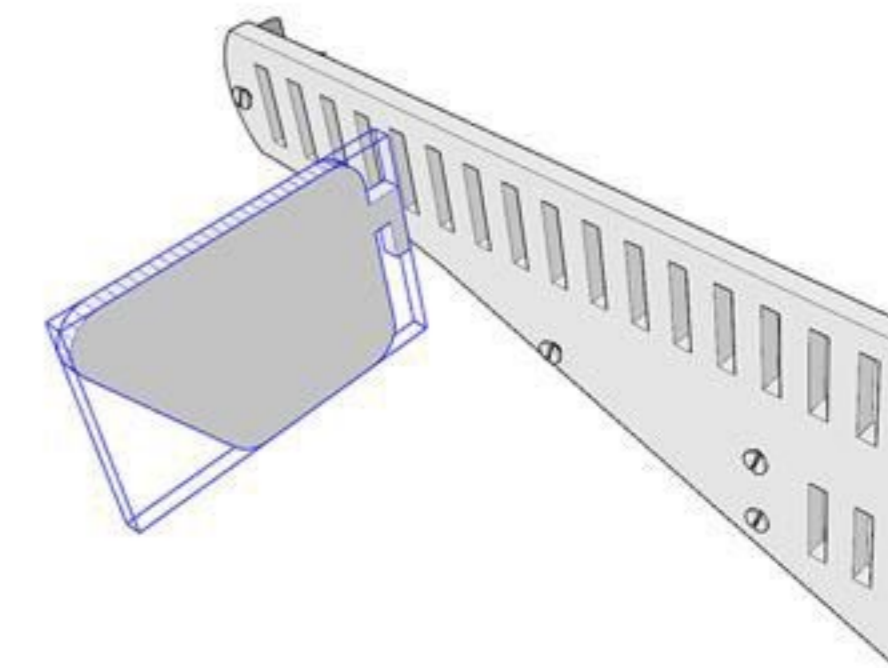

Then start to assemble pieces one by one by starting from the left of the table and start from 0.

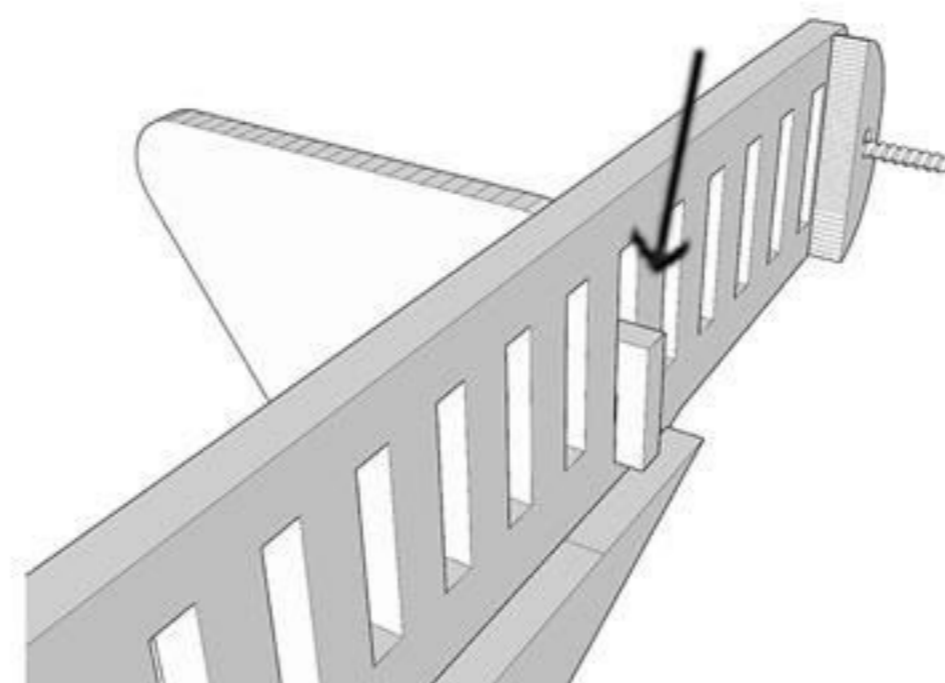
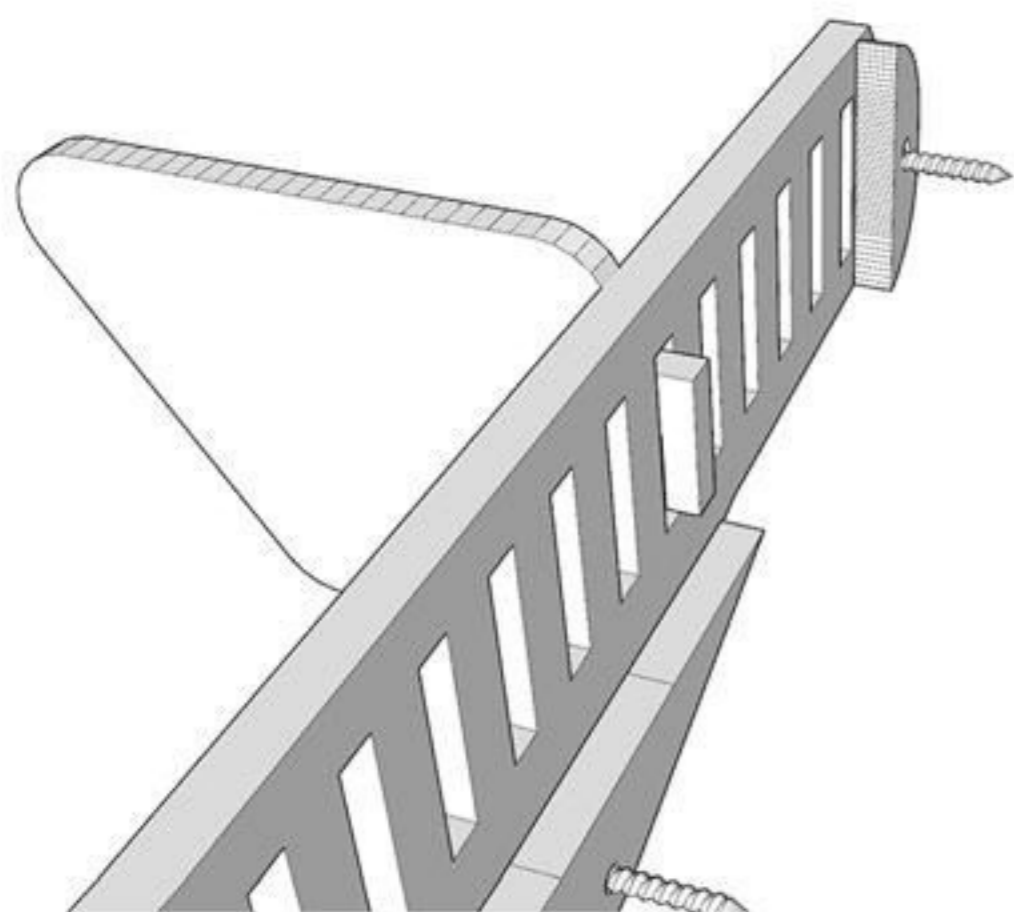

The pieces are designed to be hooked in place. After inserting them into the holes, press downwards to secure them.

