

ASSEMBLY INSTRUCTIONS

CLR0014

78"x16"x18" - ACACIA 78" LIVE EDGE BENCH

BEFORE BEGINNING:

- 1 - Carefully unpack and position the items on a clean, non-marring surface to assemble.
- 2 - Read this Assembly Instructions from beginning to end before starting to assemble.
- 3 - Take inventory of the required parts to ensure all are available.
- 4 - To prevent accidental choking hazards, keep all packaging materials away from small children.
- 5 - Only tighten hardware until ALL hardware are fully engaged on their locations. Overtighten bolts will damage the bolt threads.
- 6 - Use only factory provided hardware to assemble. Unapproved hardware can damage product or jeopardize the structural integrity of the product.
- 7 - The use of power tools to assemble is not recommended due to high risk of over-torque, which can damage product.

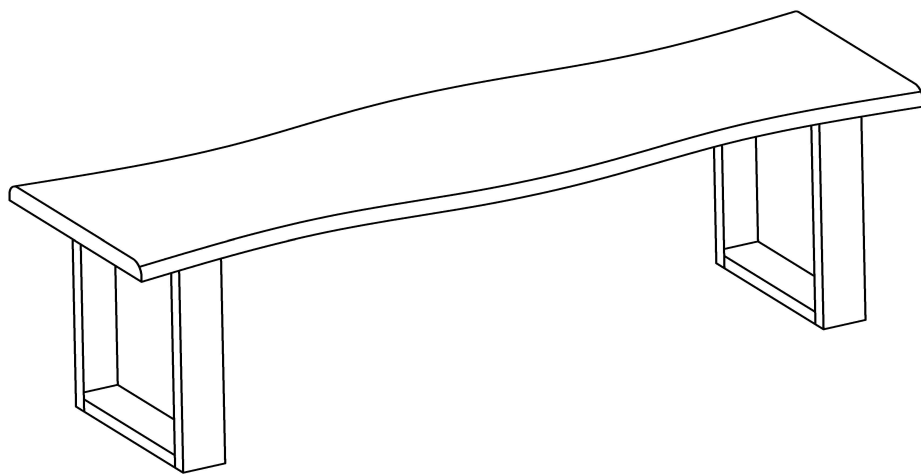

Assembly Requires
Two People.



20 - Minute
Assembly Time



Keep Instructions
For Future Use



Do Not Use
Power Tools

ASSEMBLY INSTRUCTIONS

CLR0014

78"x16"x18" - ACACIA 78" LIVE EDGE BENCH

PARTS LIST

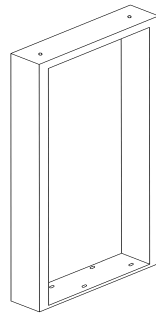
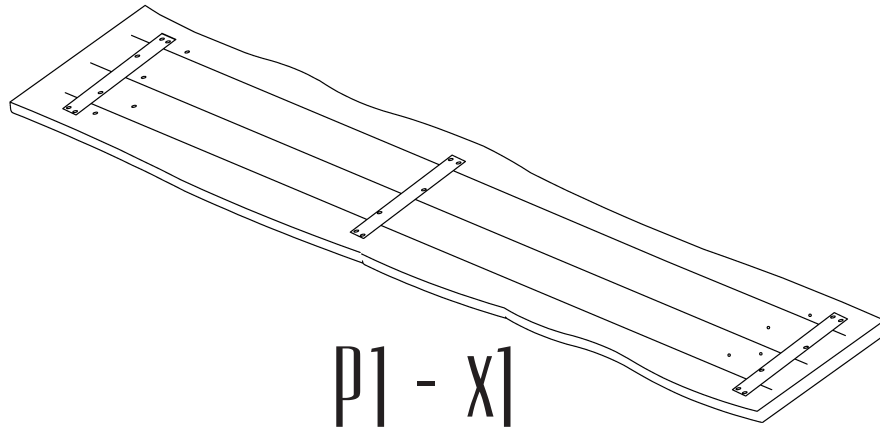

HARDWARE PACK



H1 - x8

30x8mm

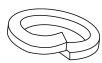

H2 - x8

16x8mm



H3 - x8

20x8mm

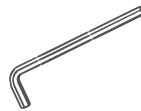

H4 - x1

5mm

ASSEMBLY INSTRUCTIONS

CLR0014

78"x16"x18" - ACACIA 78" LIVE EDGE BENCH

STEP 1

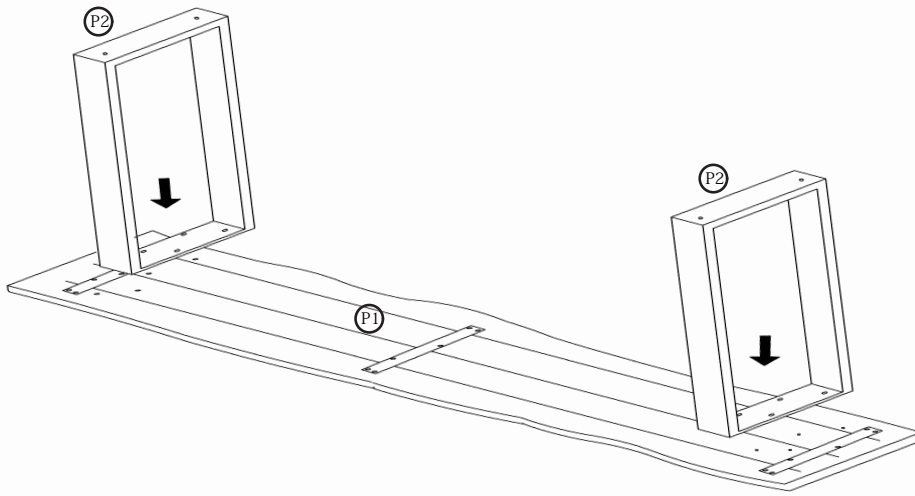

STEP 2

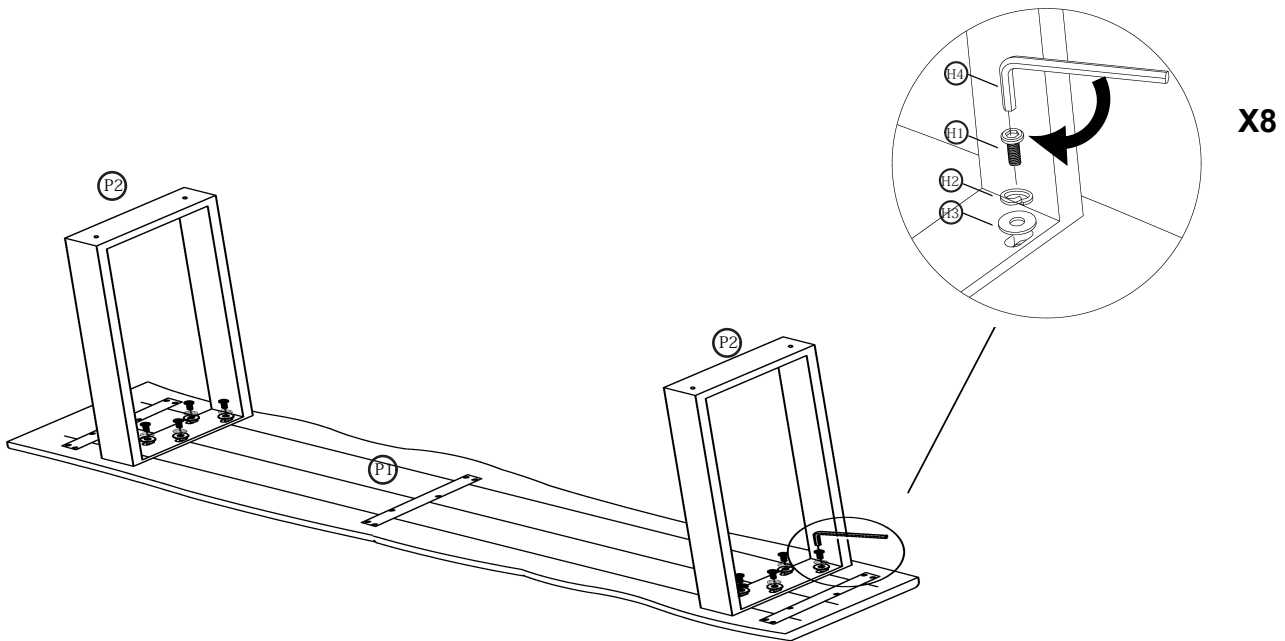

ASSEMBLY INSTRUCTIONS

CLR0014

78"x16"x18" - ACACIA 78" LIVE EDGE BENCH

STEP 3

