

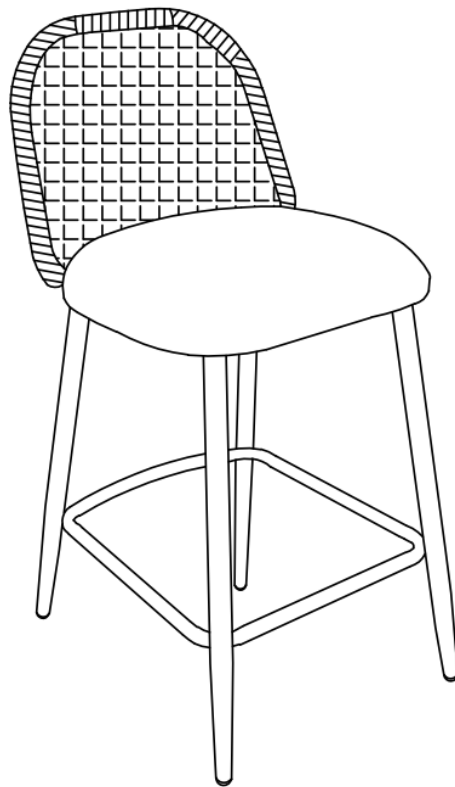

ALEXA OUTDOOR COUNTER STOOL

ALEXA



Assembly Instructions

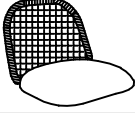

PARTS LIST

LABEL	PICTURE	DESCRIPTION	QTY
A		Base	1
B		Seat	1

HARDWARE

LABEL	PICTURE	DESCRIPTION	QTY
C		Allen key	1
D		Bolt M6*40	4

BEFORE BEGINNING ASSEMBLY:



Read instructions cover to cover



Have two adults on hand for assembly



Do NOT assemble on flooring or carpet. Assemble on a clean non-marring surface (ex: packing foam)



Save all packaging until assembly is completed

Need a part? Call TOV at 516-888-3355 or email service@tovfurniture.com

ASSEMBLY STEPS

STEP 1

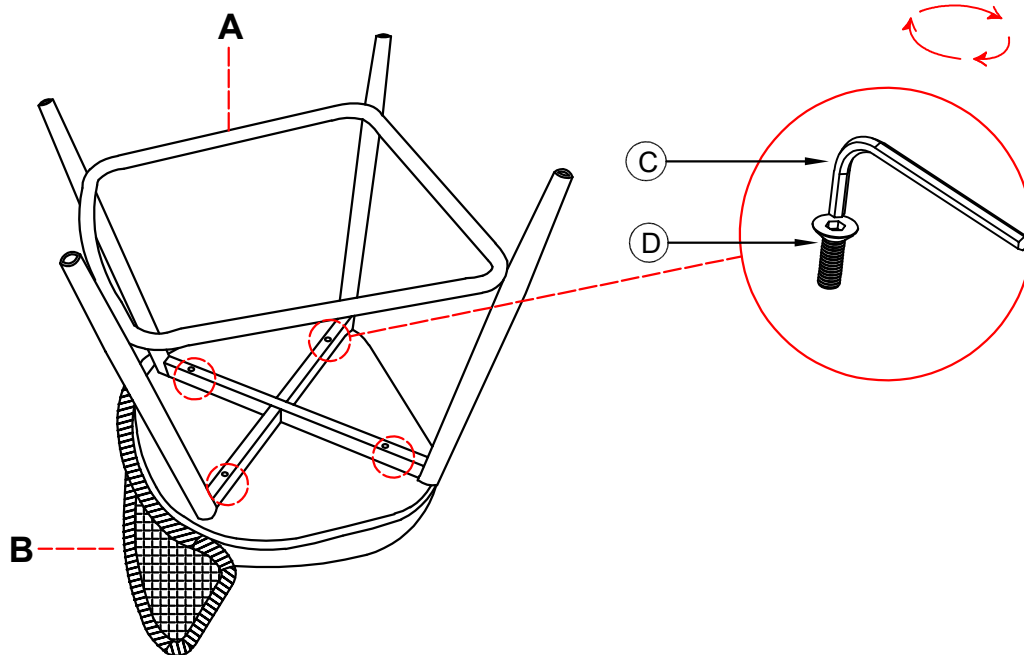

- > Turn the seat over and place it on the ground where the exterior finish will not be scratched. Align the screw holes of the chair leg with the screw holes of the seat, insert flat bolt (D) into each hole, once the screws are in place, tighten the screw until firmly attached with the allen key (C) provided.

STEP 2

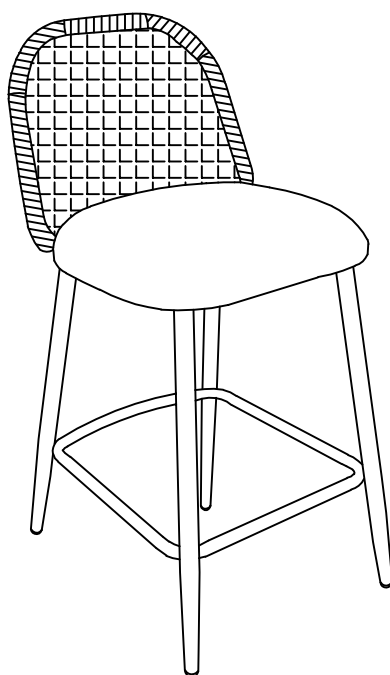

- > Turn the chair over.

CARE & MAINTENANCE

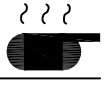

Do not put hot items directly on furniture surface.



Do not clean furniture with harsh cleansers or polish.



Dust and wipe up spills using a clean, non-colored, lint-free cloth.



Stains may be removed with mild soap solution and a damp cloth.



Do not place furniture under direct sunlight.



Do not place furniture near heating or cooling vents.



Do not write on furniture without a padded barrier to protect the surface.