

Assembly Instruction

Model:4751

Thank you for purchasing this quality product! Make sure all components and small hardware parts included in the package you start to assemble the product.

Components List

Hardware List

Serial NO.	Description and Drawing	Quantity	Serial NO.	Description and Drawing	Quantity
1		1	A		8
2		4			

Step1

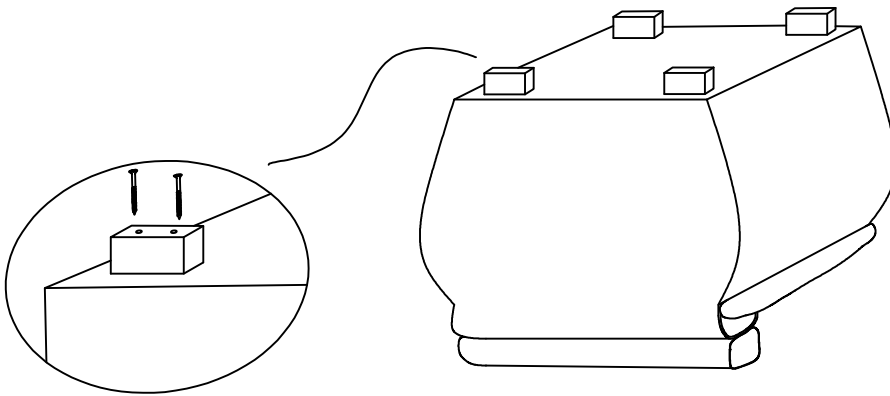

Step2 Finished

