

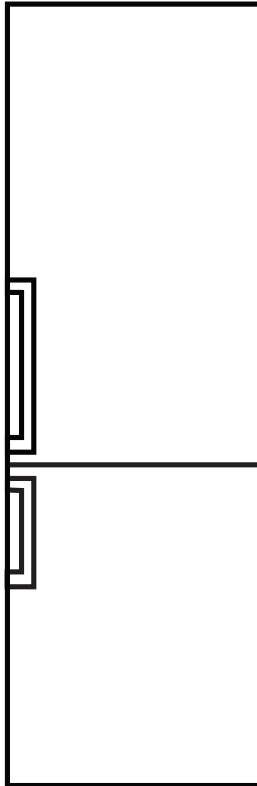

Refrigerator - Freezer

Bottom Mounted

Model - RF 331-120



OWNER'S MANUAL

Please read the instructions carefully and keep for future reference. Information may be updated from time to time so please refer to the manual online for the latest version of the manual.

Warranty

Conserv Appliances undertakes to the consumer-owner to repair or, at our option, to replace any part of this product which proves to be defective in workmanship or materials under normal personal, family or household use, in the USA and Canada, for a period of one year from the date of original purchase. For commercial use, the product is warranted for a period of 90 days. During this period, we will provide all labor and parts necessary to correct such defect, free of charge, if the appliance has been installed and operated in accordance with the written instructions with the appliance. Ready access to the appliance, for service, is the responsibility of the consumer-owner. Service would be provided from Monday to Friday between normal business hours.

Exclusions

In no event shall Conserv Appliances be liable for incidental or consequential damages or for damages resulting from external causes such as abuse, misuse, incorrect voltage or acts of God. This warranty does not cover service calls which do not involve defective workmanship or materials covered by this warranty. Accordingly, diagnosis and repair costs for a service call which does not involve defective workmanship or materials will be the responsibility of the consumer-owner.

Specifically, the following work is not covered under warranty and does not constitute warranty work:

Installation - e.g. Insufficient spacing around appliance

Maintenance - e.g. Cleaning the appliance using solvents

Mishandling - e.g. Breakage of door and shelves

Most work is covered. The defining factor is, has the machine malfunctioned (Conserv Appliances is responsible) or has the customer omitted or done something to cause the appliance to malfunction (customer is responsible). Some states do not allow the exclusion or limitation of incidental or consequential damages, so the above limitation of exclusion may not apply to you.

WARRANTY SERVICE

This warranty is given by:

Conserv Appliances

10222 Georgibelle Drive, Suite 200,
Houston, Texas 77043-5249

For Customer Service:

Appliance Desk

Phone/Text: 1-800-776-3538

Email: Service@ApplianceDesk.com

Web: www.ApplianceDesk.com

Business hours: 9:00 am to 5:00 pm weekdays

You can register your warranty by either of the following methods:

1. Scan QR Code

QR Code



1. Open Smart Phone
2. Open Camera
3. Scan QR Code
4. Click the Link

2. Register online at ApplianceDesk.com/Warranty

GENERAL

Since it is the responsibility of the consumer-owner to establish the warranty period by verifying the original purchase date, Conserv Appliances recommends that a receipt, delivery slip or some other appropriate payment record be kept for that purpose.

This warranty gives you specific legal rights, and you may also have other rights which vary from State to State.

All rights reserved. Manual subject to change without notice

Congratulations on your new Refrigerator - Freezer!

In addition to its contemporary design, this is a highly sophisticated engineered product that will give you many years of satisfaction.

Here are some of the best reasons for buying your appliance:

- Can be placed in a garage.
- Includes a 5-bottle wine rack.
- Equipped with easy open swing handle.
- Has humidity control for keeping food fresh.
- Has adjustable shelves for customizing space.
- Has interior LED lights both on top and the sides.
- Has wide space door shelf for storing gallon size bottles.
- Uses an Inverter Compressor which makes it energy efficient.

Safety

Please always follow the safety precautions listed below:



- Do not put acid or flammable or volatile materials inside the appliance.
- Do not puncture or damage refrigerant tubing.
- Unplug the unit immediately if you find any abnormal smell or smoke, and contact Customer Service.
- Do not use the power cord or plug if it is damaged.
- Use a dedicated power outlet and a three prong power socket, that is properly grounded.
- Secure the cord behind the unit to prevent a tripping hazard.
- Do not use extension cords or ungrounded two prong adapters.
- When removing the power plug, do not pull on the cord. Grasp the plug firmly and pull it out from the socket.
- Do not connect or disconnect plug with wet hands.
- Unplug the unit first when doing maintenance or repair.
- Keep ventilation openings free of obstructions.
- Repairs must be done only by a qualified technician.
- This appliance is not intended for use by persons (including children) with reduced physical, sensory or mental capabilities, or lack of experience and knowledge, unless they have been given supervision or instruction concerning use of the appliance by a person responsible for their safety. Children should be supervised to ensure that they do not play with the appliance.
- CAUTION: To prevent a child from being entrapped, keep out of reach of children and not in the vicinity of freezer or refrigerator.

Safe Disposal

- WARNING: Risk of child entrapment. Before discarding the appliance, remove the doors and leave the shelves in the place so that children may not easily climb inside.
- WARNING: The refrigeration system is under high pressure. Do not tamper with it. Contact qualified service personnel before disposal.
- Dispose off this appliance in accordance with local regulations.

Installation

This appliance is designed to be freestanding and not built-in.

This appliance is not intended for use at altitudes exceeding 6500 ft.

- Before connecting the appliance, ensure the voltage requirements are correct.
- Keep the appliance standing upright and stable for 2 hours, before plugging it in.
- Place the appliance in a dry and well-ventilated environment.
- Do not put the appliance in direct sunlight and keep it away from heat sources.
- Do not put the appliance in a cold area, outdoors or where it will be exposed to rain. However, it can be placed in a garage, where it must be within the temperature range: 38° ~ 110° F.
- Place the appliance on flat and stable ground. Keep it level by adjusting the feet. This must be done before placing food in it.
- Ensure the plug is accessible after installation.
- Ensure the appliance is at least 20 inches away from stoves, gas ovens and heaters, and at least 2 inches away from electric ovens.
- Ensure there is a space of at least 6 inches (15 cm) above and 2 inches (5 cm) on either side of the appliance.
- Install the plastic distance guide(s) on the condenser (black grid at the back of the appliance) by turning it 90° (see figure) to prevent the condenser from touching the wall. The distance between the appliance and back wall must be at least 3 inches (7.6 cm).
- Do not place any items, especially anything heavy, on top of your appliance.

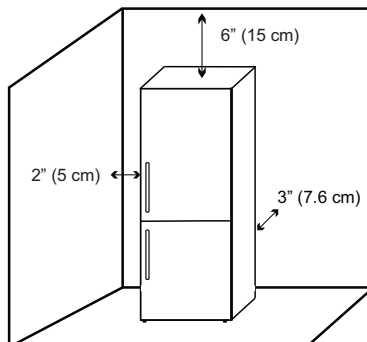
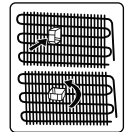

Operation

This appliance is intended for household use.

- This refrigerator is equipped with new-generation cooling technology, which uses a fan to blow dry cold air evenly throughout the interior. The cold air cools food evenly and uniformly.
- When the refrigerator is first turned on, allow it to run for 24 hours in order to reach operating temperature. During this time, do not open the door and do not keep any food inside.
- Your refrigerator may have an odor when it is operated for the first time. This is normal and the odor will fade when it starts to cool.
- It is recommended that you clean the interior of the unit before placing food inside.
- The shelves are adjustable to provide more space options. Simply remove and place the shelves in the grooves on the sides of the refrigerator.
- The appliance is equipped with a 5-bottle wine rack, which can be removed.
- LED lights in the interior of the appliance, both on top and on the sides provide superior lighting.

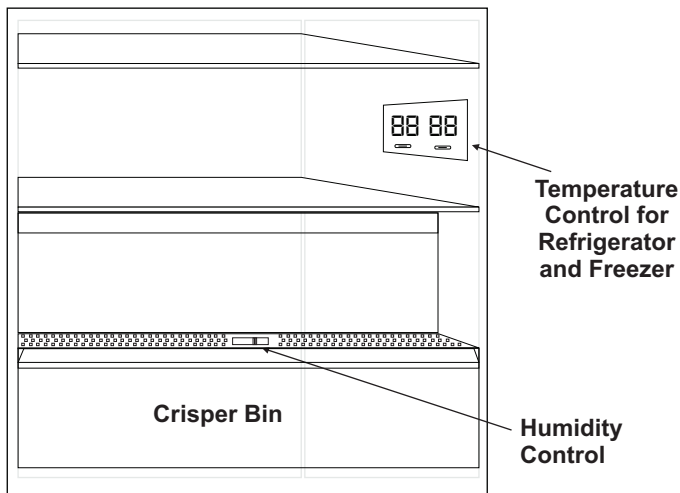

Control Panel

1. Freezer button to set temperature
2. Refrigerator button to set temperature
3. Freezer temperature display
4. Refrigerator temperature display
5. Eco mode symbol
6. Super freeze symbol
7. Alarm symbol

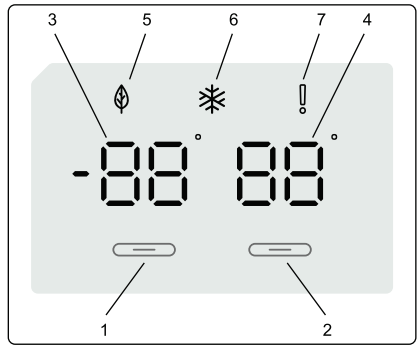

Temperature Settings

The default temperature setting for the freezer is 0°F (-18°C). At this setting the appliance is automatically in Eco Mode (5), and the Eco symbol ♻ will illuminate. To decrease the temperature, press the left freezer button (1). The temperature decreases in 2-degree increments.

The default temperature setting for the refrigerator is 39°F (4°C). To change the temperature, press the right refrigerator button (2). The temperature changes in 2-degree increments.

Super Freeze can be used to freeze food quickly. To activate Super Freeze mode (6), press and hold the Freezer button (1) for 3 seconds. The Super Freeze symbol ❄ will illuminate, and a beep will sound to confirm that the Super Freeze mode is on. To cancel Super Freeze mode, press and hold the Freezer button for 3 seconds, or it will automatically cancel after 24 hours.

Changing the temperature display

To change the temperature display setting from °F to °C:

1. Press the refrigerator button to set the temperature to 39.
2. When the flashing stops, press and hold the button for 10 seconds.
3. The display will change to °C.

To change the temperature display setting from °C to °F:

1. Press the refrigerator button to set the temperature to 4.
2. When the flashing stops, press and hold the button for 10 seconds.
3. The display will change to °F.

Door Open Alarm

If the refrigerator or freezer door remains open for more than 2 minutes, an alarm will sound and the Alarm symbol ! will illuminate.

Humidity Control

The Crisper Bin is meant for the storage of items, such as fruits and vegetables. In order to keep these items fresh, the humidity or amount of cool air entering this bin can be controlled by sliding the Humidity Control lever to the left or right. Slide the lever to the left to let more cool moisture in or slide it to the right to keep the contents of the bin more dry.

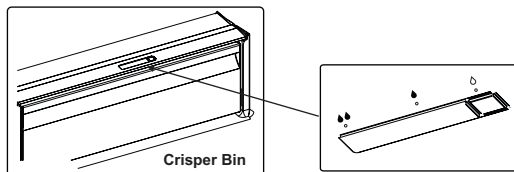

Maintenance

- Always unplug the appliance before cleaning.
- Clean inside, behind and around the refrigerator regularly, using water and mild detergent, and a damp cloth (not wet).
- Never use boiling water, harsh cleaning chemicals or abrasive materials.
- Check and clean the door gasket regularly to ensure that the door closes and seals properly.

Defrosting

The appliance has an automatic defrost mechanism. The defrost water collects in a tray behind the appliance and evaporates there. Usually, it does not need special care, but if there is water on the floor or an odor, it may need to be checked and cleaned.

1. Remove the plug from the socket.
2. Gently move the appliance forward to safely access the back.
3. Remove the screws to release the water tray from its position.
4. Empty and clean the tray with a mild detergent.
5. Replace the tray and secure with the screws to its original position.
6. Install and connect the appliance.

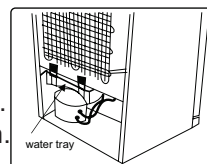

Extended Absence or Vacation

- If the appliance will be switched off for a long time, the plug should be pulled out, and the appliance cleaned thoroughly.
- The door must be left open and place the appliance in a well ventilated area to avoid build up of odor.

Troubleshooting

Many common problems can be easily solved, saving you the cost of a possible service call. Please see the Troubleshooting Guide below to solve problems before calling for service.

Problem	Possible Cause
Does not work	<ul style="list-style-type: none">• Power is not on or the unit is not connected to power• Check if it is plugged in correctly to the power source• Check fuse and power socket• Low voltage
Not Cooling	<ul style="list-style-type: none">• Temperature is not set correctly. Adjust the temperature• Move unit if near a heat source or in direct sunlight• Check for proper ventilation around the appliance• Check if there are too many items in the appliance• Door opened frequently or not shut properly• Door seal is damaged
Too much noise	<ul style="list-style-type: none">• Appliance not placed on flat surface or not level. Adjust the feet to level it• Appliance is against a wall. Move to ensure 3" space behind unit
Doors does not close properly	<ul style="list-style-type: none">• Check the door seal• Shelves are not positioned properly. Adjust the shelves• Ensure no items in the appliance are obstructing the door from closing• Ensure the appliance is level

The following phenomenon is normal

- Sound of fluid is the compressor when it is starting or stopping
- Flowing sound of refrigerant in the refrigeration system
- Condensation forming – wipe with dry cloth

In order to prevent damage to the compressor, the refrigerator is equipped with a 5-minute delay function. This means that when connecting or disconnecting to the mains or if there is a power failure, the refrigerator will require 5 minutes to begin operating normally.

Error Codes

If there is a malfunction in the appliance, an error code will be displayed on the control panel to indicate the problem.

Error Code	Error	What To Do
E01	Freezer Sensor fault	Check connection or replace parts*
E02	Refrigerator Sensor fault	Check connection or replace parts*
E03	Evaporator (Defrost) Sensor fault	Check connection or replace parts*
E04	Ambient Temperature Sensor fault	Check connection or replace parts*
E05	Evaporator Sensor fault	Check connection or replace parts*
E06	Compressor defect	Check compressor*
E07	Defrost Heater defect	Check defrost heater*
E09	Freezer not cold enough	Set the freezer temperature to a colder setting or set Super Freeze to cool quickly.
E10	Refrigerator not cold enough	Set the refrigerator temperature to a colder setting.
E11	Refrigerator is too cold	Set the refrigerator temperature to a less cold setting. Check if ventilation is blocked.

*Call Customer Service to send a technician for service.

Technical Specifications

Model	RF 331-120
Electrical	115 - 127V / 60 Hz / 1.1 A
Total Capacity	11.7 cu. ft.
Refrigerator Capacity	8.1 cu. ft.
Freezer Capacity	3.6 cu. ft.
Temperature Range (Fridge / Freezer)	36°~ 46°F / -3°~ -11°F
Net Weight (lbs)	136.7
Product Dimensions H x W x D (inch)	73.2 x 23.4 x 25.6

State of California Proposition 65 Warnings:

WARNING: This product contains one or more chemicals known to the State of California to cause cancer.

WARNING: This product contains one or more chemicals known to the State of California to cause birth defects or other reproductive harm.

