

# ATTENTION !

STEP 5

Please refer page 2/6, choose a right hinges to assemble correct door.  
Use Screw (A2) to assemble a Soft Closing Hinges 2/8" (E4) & Soft Closing Hinges 5/8" (E5).

\* Please refer page 2/6.

\* Please refer page 2/6.

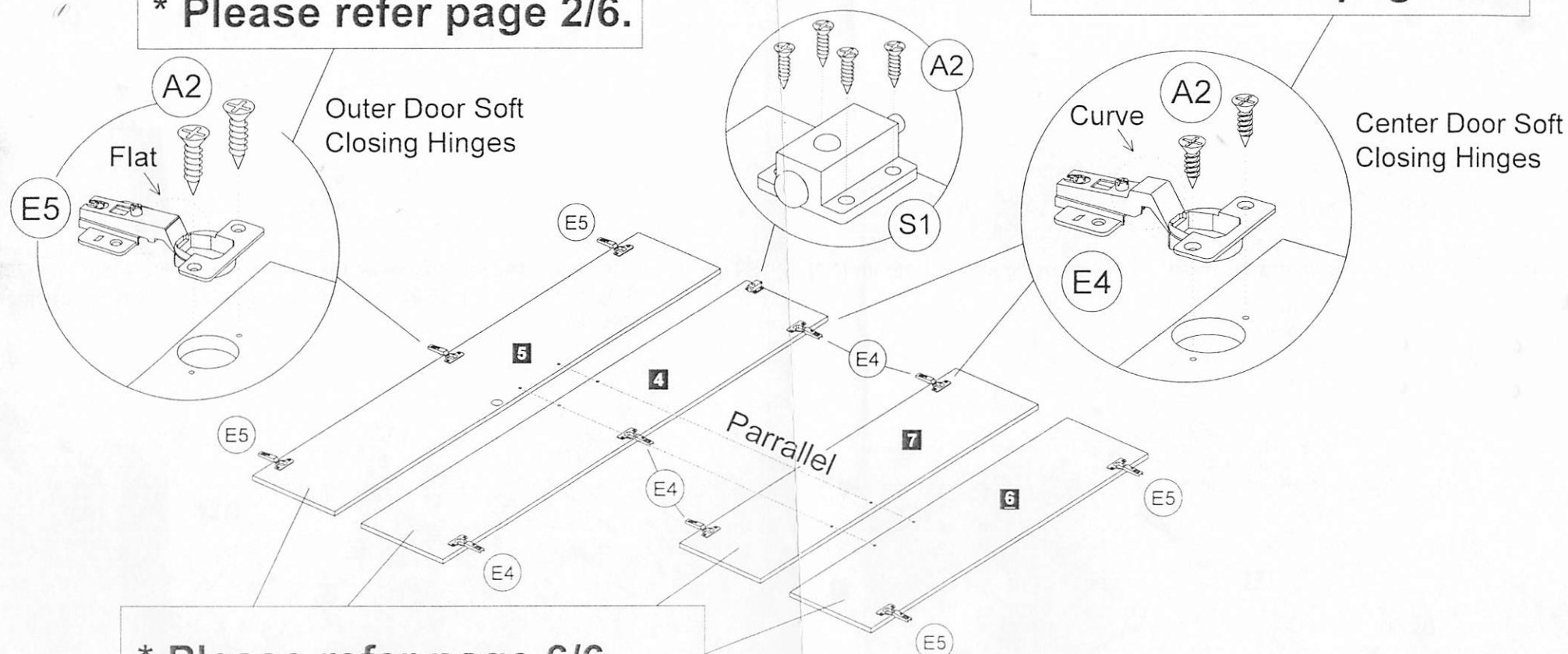

**STEP 1** First, fix the Mini Fix Bolt (F2) screw at all panel no. 8 & 9. Insert the Wood Dowel (D4) at both panel no. 20. Use Screw (A4) to assemble the Square Lock Set (C5) at panel no. 8. Use Screw (A7) to assemble Handle (H6).

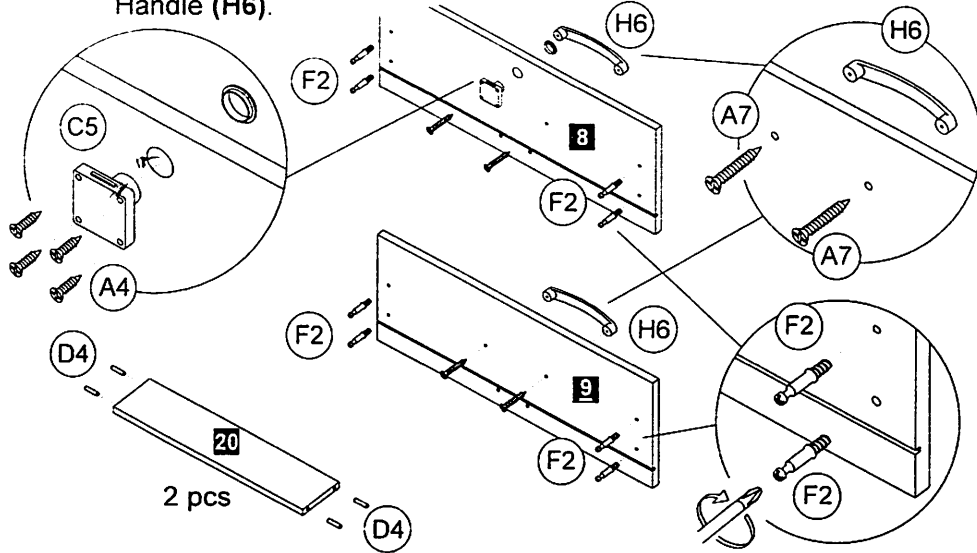

**STEP 2** Assemble 2 sets of drawer using Screw (A10) in repeated at step 2.

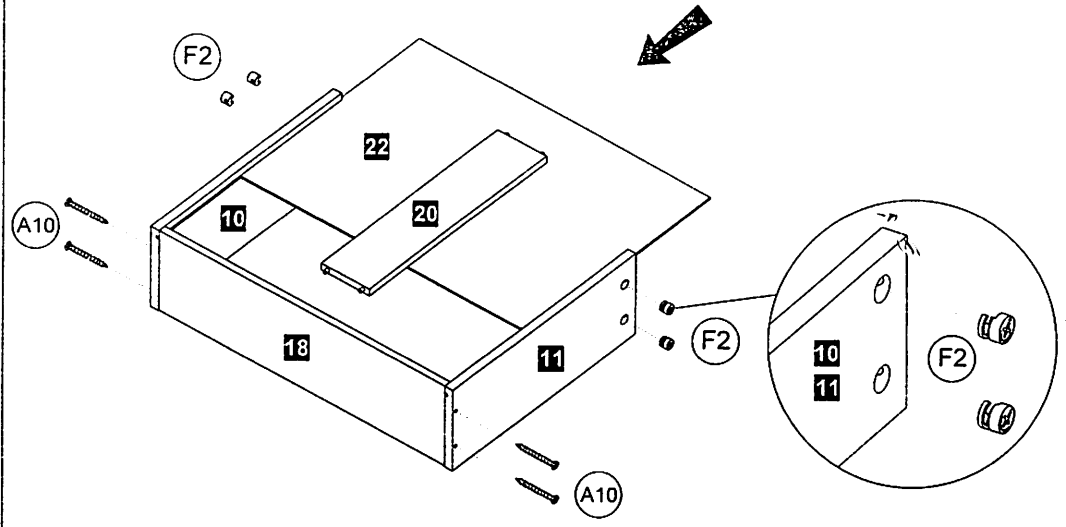

**STEP 3** Assemble 2 sets drawer head panel with using Mini Fix 15mm (F2).

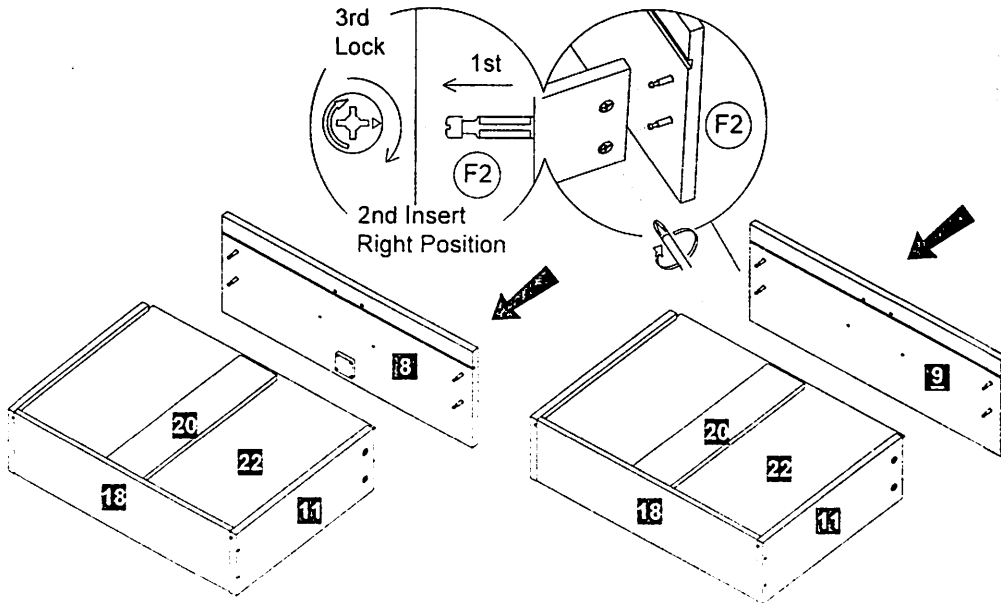

**STEP 4** Use Screw (A2) to assemble the Drawer Metal Slide 400mm (M7) & Single Plastic Cap (R2). Assemble 2 sets of drawer in repeated at step 4

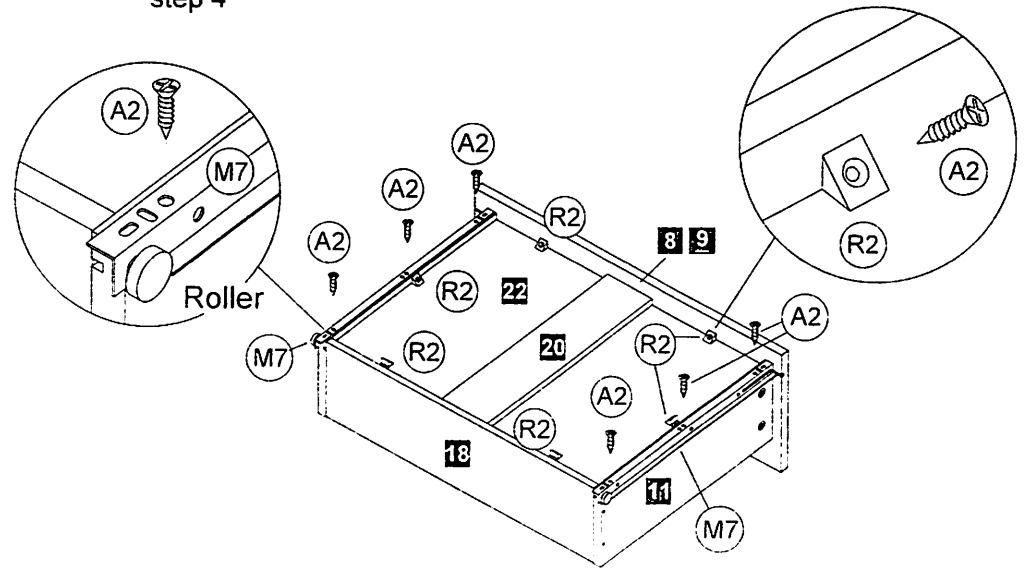

Reference Screw Size.

Place your screw on top to identify the size

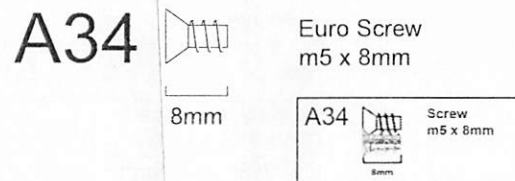
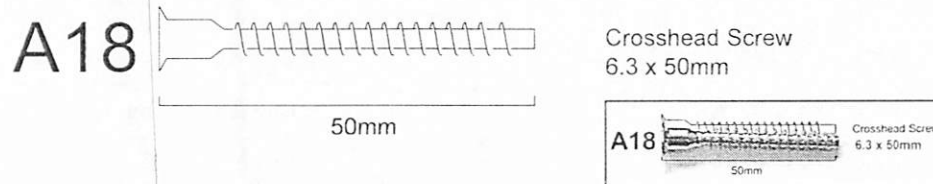
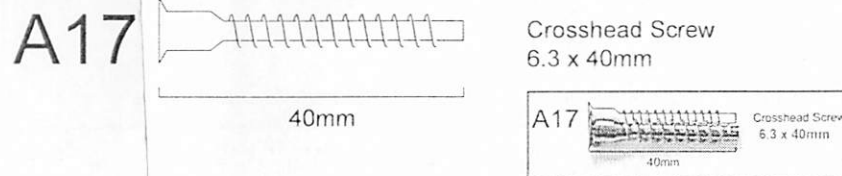
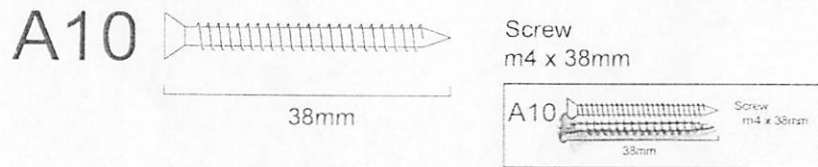
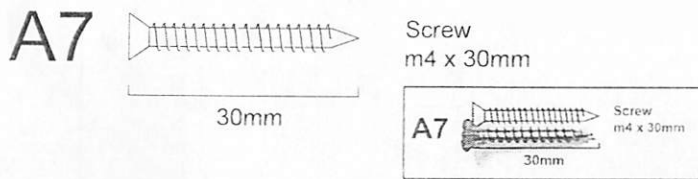
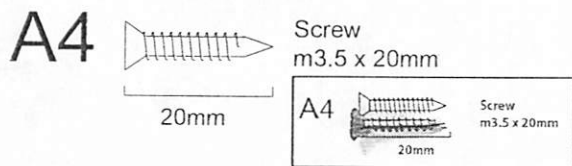
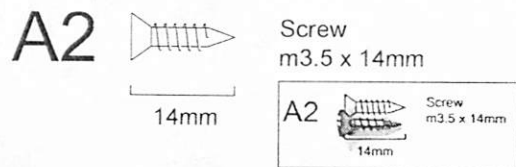
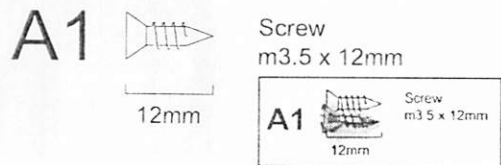

# ATTENTION !

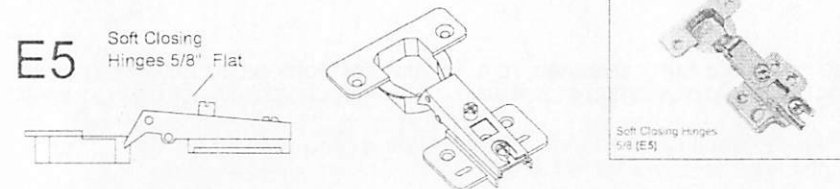
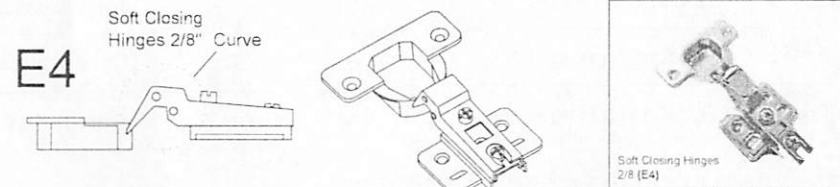























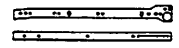

Before you begin, please follow assembly instruction carefully, then follow step by step.

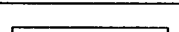
Read instruction carefully. See furniture Parts List and Hardware List for guidance. Be sure you have all parts before you start assembling. Place and assemble furniture on a clean flat soft surface, such as carpet, rug or carton to prevent being scratched.

### Reminder :

Please ensure that all surface and edges with colours / laminations are facing forward / outward.

HARDWARE LIST			QTY
A1		Screw m3.5 x 12mm	2
A2		Screw m3.5 x 14mm	128
A4		Screw m3.5 x 20mm	8
A7		Screw m4 x 30mm	12
A10		Screw m4 x 38mm	8
A17		Crosshead Screw 6.3 x 40mm	22
A18		Crosshead Screw 6.3 x 50mm	6
A34		Euro Screw m5 x 8mm	8
C5		Square Lock Set	2 sets
C8		Square Lock L Bracket	1
D4		Wood Dowel 6 x 25mm	16
E4		Soft Closing Hinges 2/8	5
E5		Soft Closing Hinges 5/8	5
F2		Mini Fix 15mm	8 sets
H6		Handle 128mm (Silver)	6
L1		Leg Pin	2
L2		Plastic Leg L Shape	4
M7		Drawer Metal Slide 400mm	2 sets
N1		Allen Key	1
N3		Nail	70 (+-3)
P		Hanging Steel Pipe 18mm x 588mm	2
Q4		Plastic Shelf Support with Steel Pin	8
R1		L Bracket	2
R2		Single Plastic Cap	12
S1		Door Catches	1
S2		Door Stopper	2
Y		Crosshead Cover	20

Each pack have contain different type hardware and size of screw for easy assemble.

Please refer to page 2, check a screw size.

### CAUTION

MATERIAL USE LAMINATED PARTICLE BOARD, TO CLEAN USE SOFT, DRY CLOTH. DO NOT USE DETERGENT OR CHEMICAL. AVOID CONTACT WITH WATER AND DIRECT SUNLIGHT. TO BE ASSEMBLED ON A SOFT, DRY, CLEAN SMOOTH SURFACE.

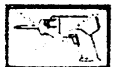

USE OF POWER TOOLS TO ASSEMBLE THIS PRODUCT WILL INVALIDATE ANY CLAIM AND MAY DAMAGE THIS PRODUCT MAKING IT UNSAFE.

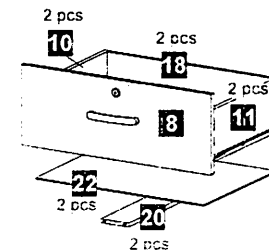
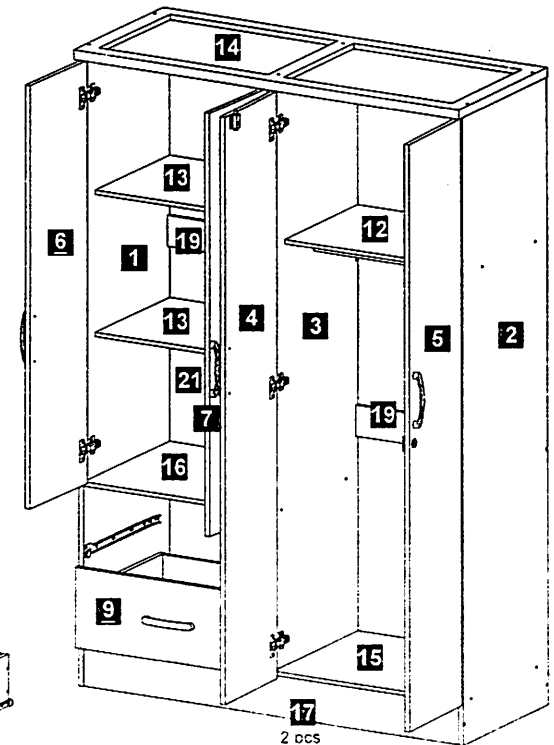
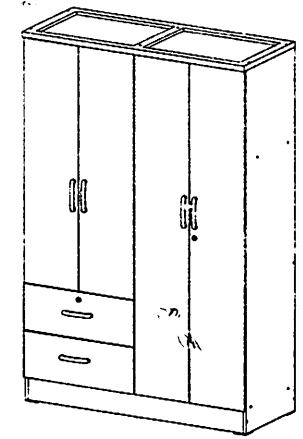

**STEP 10** Screw the Plastic Leg L Shape (L2) at between panel no. 17 & side panel. Assemble the back panel no. 21 with secure by Nail (N3). Panel no. 15 & 19 secure by Screw (A2).

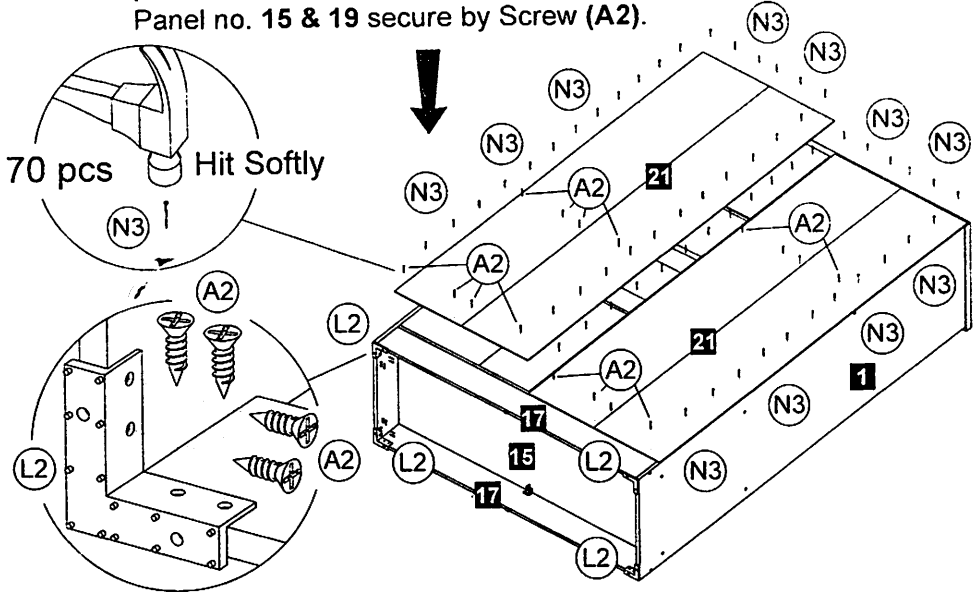

COMPLETE

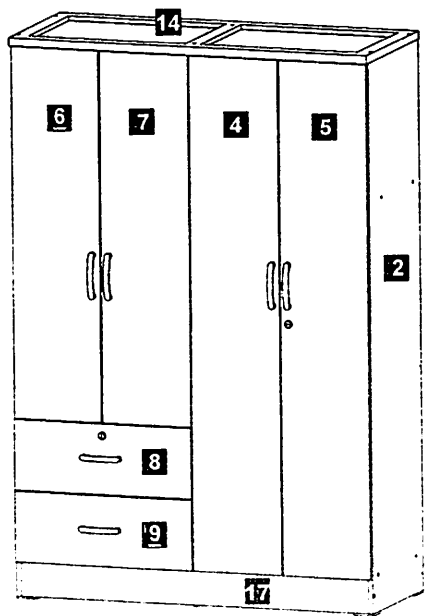

**STEP 11** Insert a Plastic Shelf Support with Steel Pin (Q4) at panel no. 1 & 3 before installing panel no. 13. Attach door & adjusting a hinges screw to parallel between a door gap. Use Screw (A4) to assemble the Square Lock Set (C5) at panel no. 5. Use Screw (A2) to assemble Soft Closing Hinges 2/8" (E4) and 5/8" (E5).

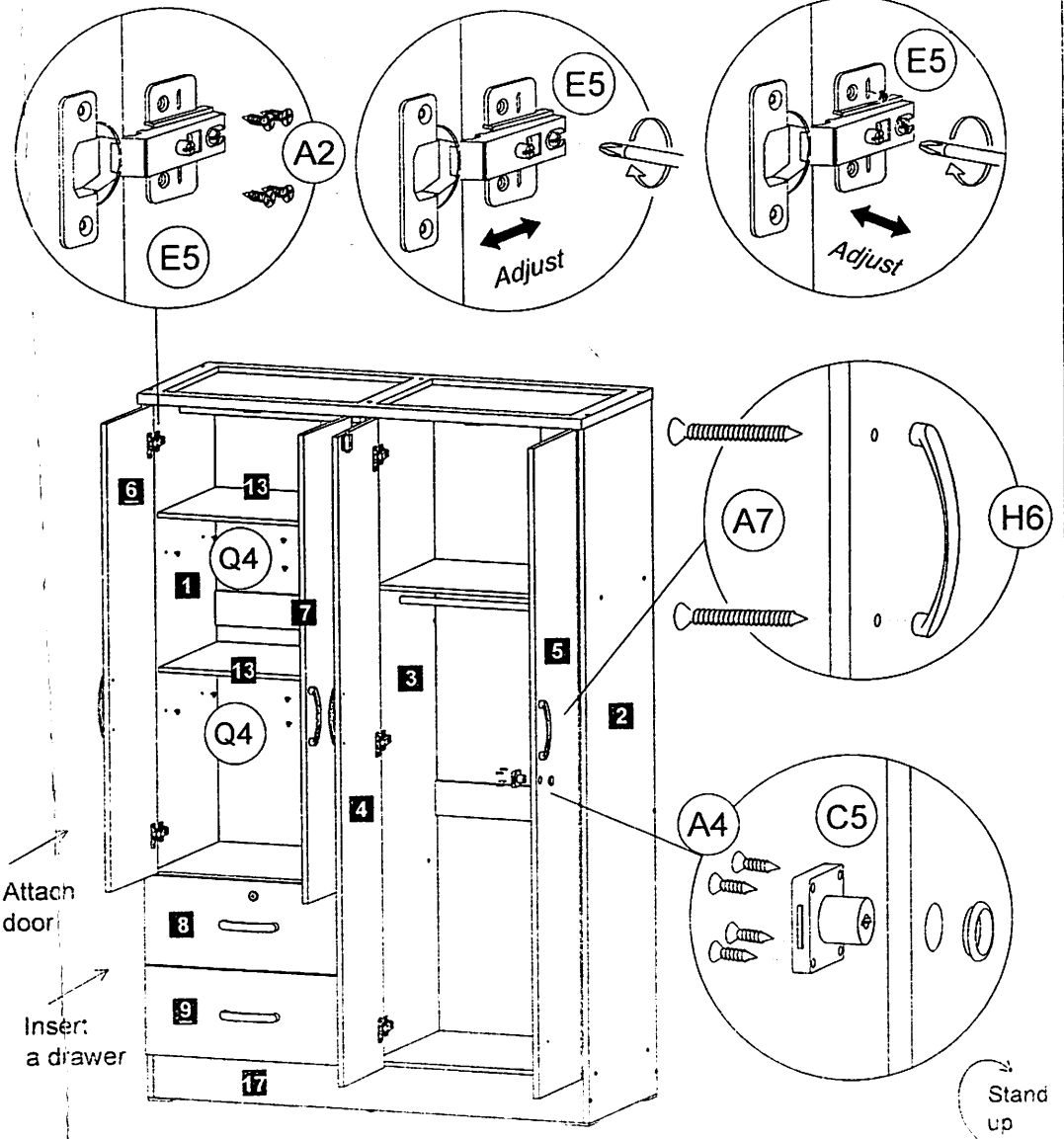

**STEP 6** Use Euro Screw (A34) to assemble a Drawer Metal Slide 400mm (M7) at marking hole panel no. 1 & 3. Use Screw (A1) to assemble the Square Lock L Bracket (C8) at panel no. 16. Insert a Wood Dowel (D4) & nail a Leg Pin (L1) at side center position at panel no. 17.

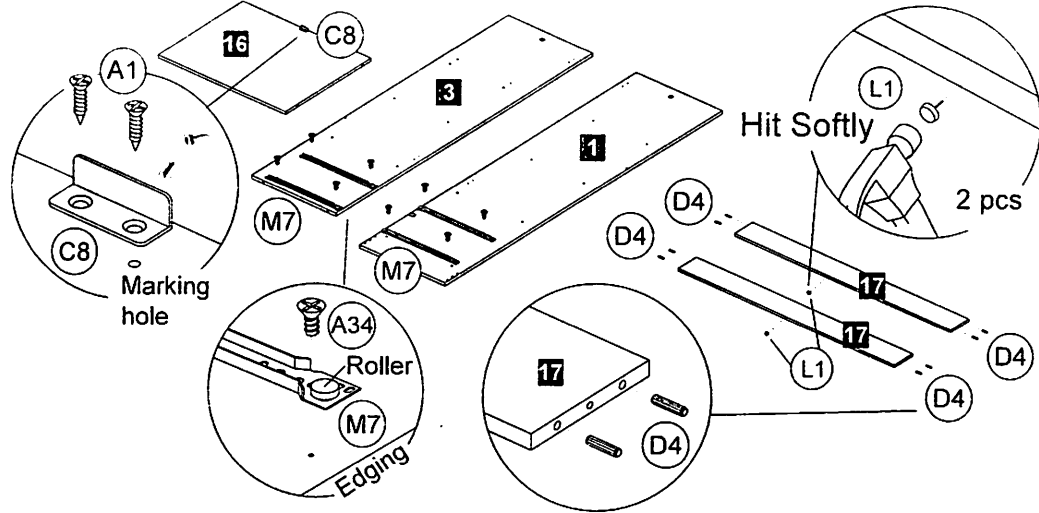

**STEP 7** Insert the Hanging Steel Pipe (P). Use Allen Key (N1) to tighten the Crosshead Screw m6.3 x 40mm (17) & button the screw head with Crosshead Cover (Y) except crosshead screw at panel no. 15.

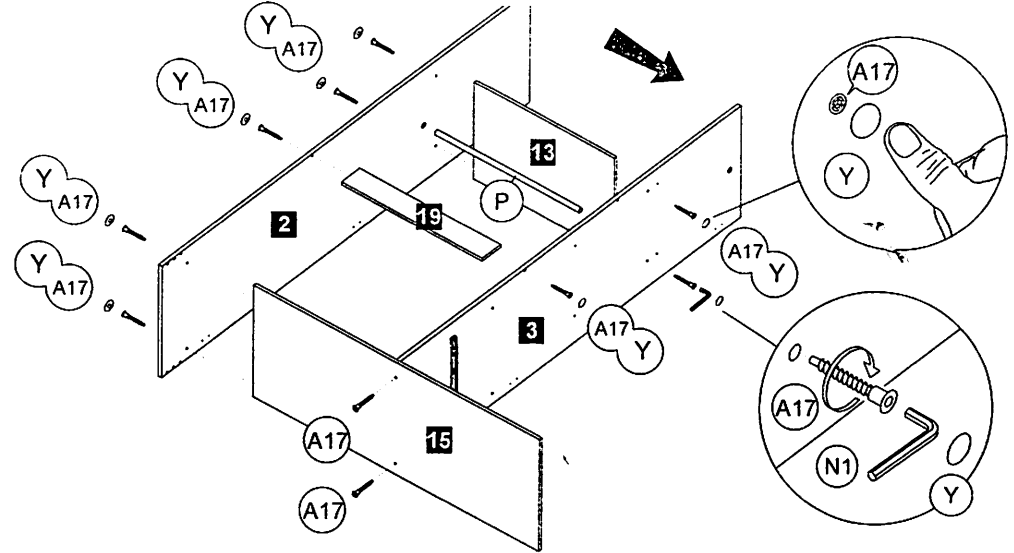

**STEP 8** Use Allen Key (N1) to tighten the Crosshead Screw m6.3 x 40mm (A17) & button the screw head with Crosshead Cover (Y). Insert Hanging Steel Pipe (P).

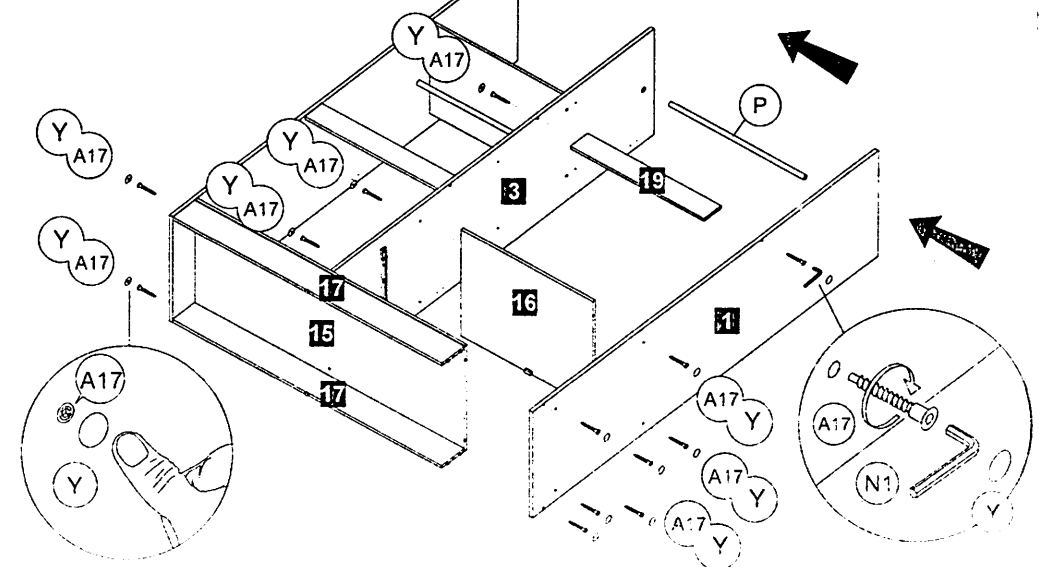

**STEP 9** Use Allen Key (N1) to tighten the Crosshead Screw m6.3 x 50mm (A18) & button the screw head with Crosshead Cover (Y).

