

4

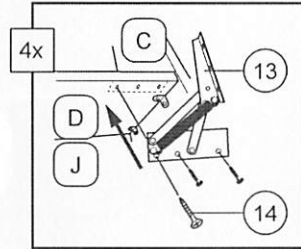

7

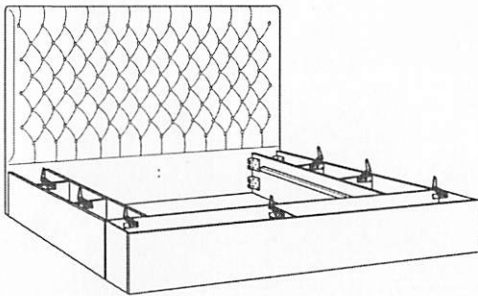
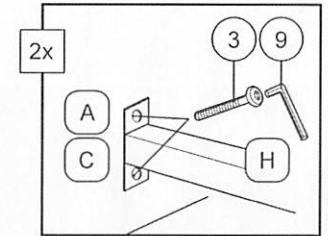
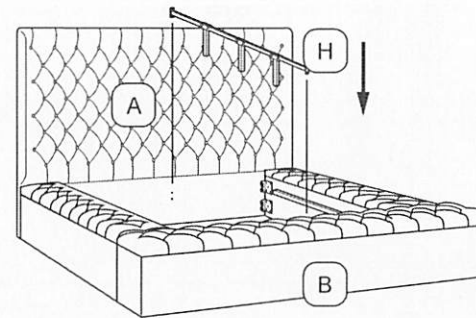

5

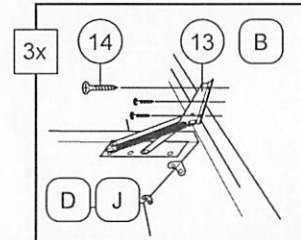
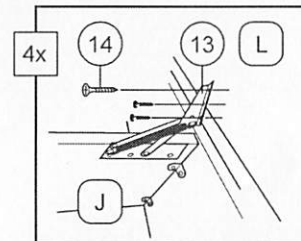
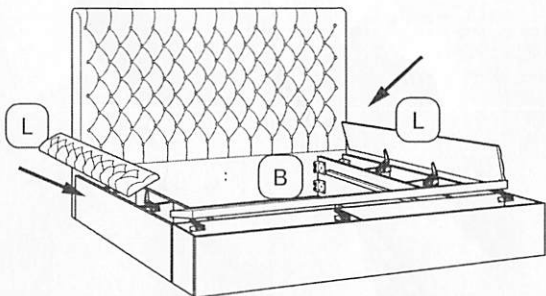

8

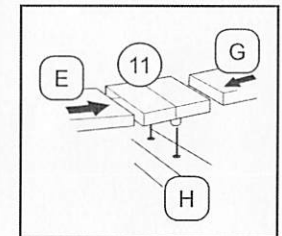
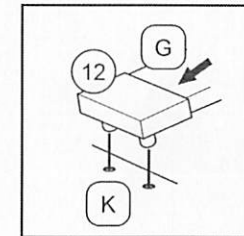
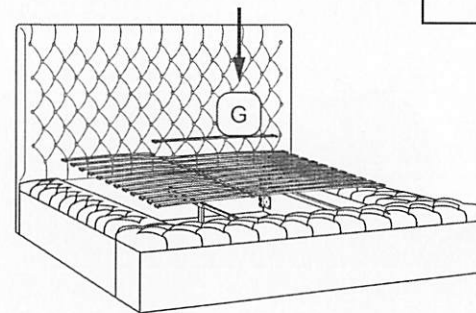

6

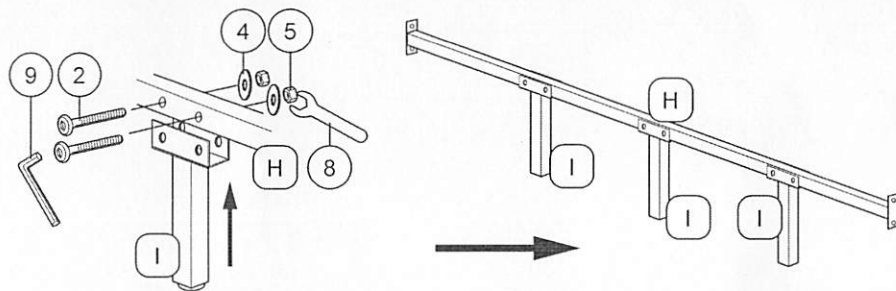

COMPLETED ASSEMBLY

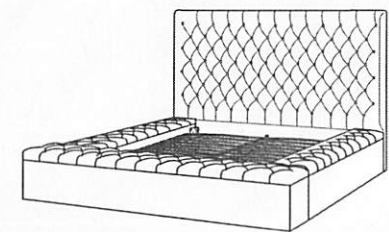

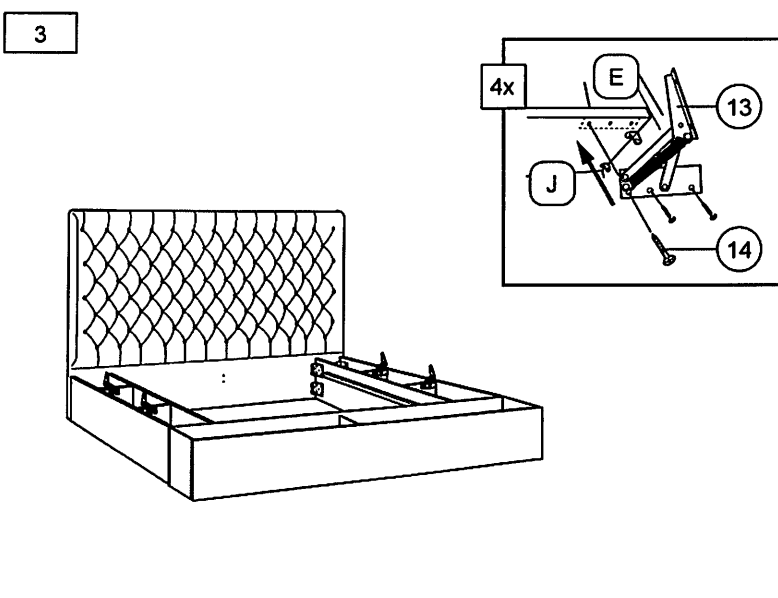
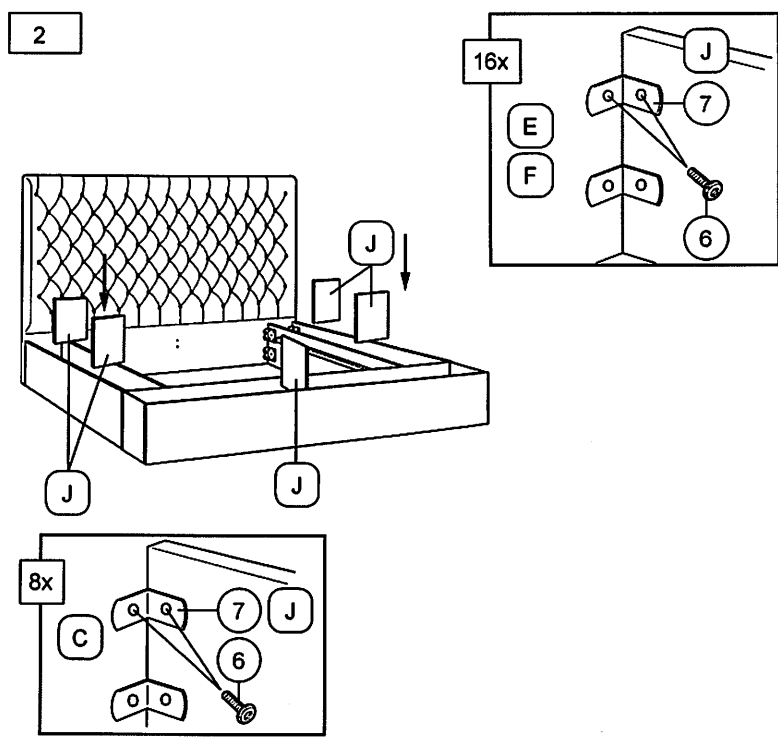
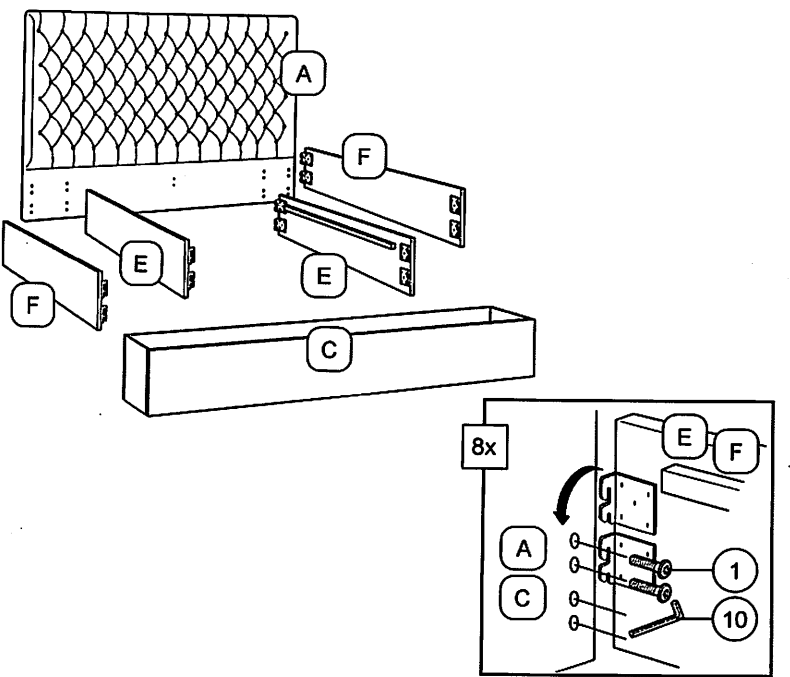
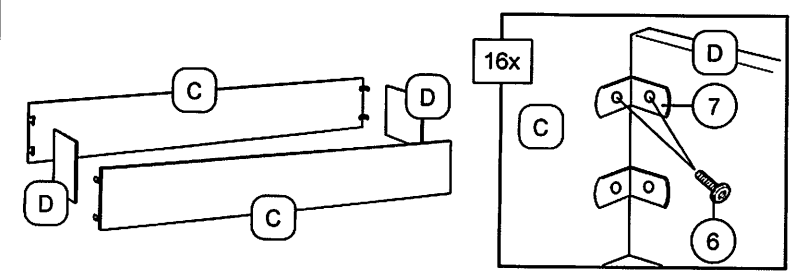
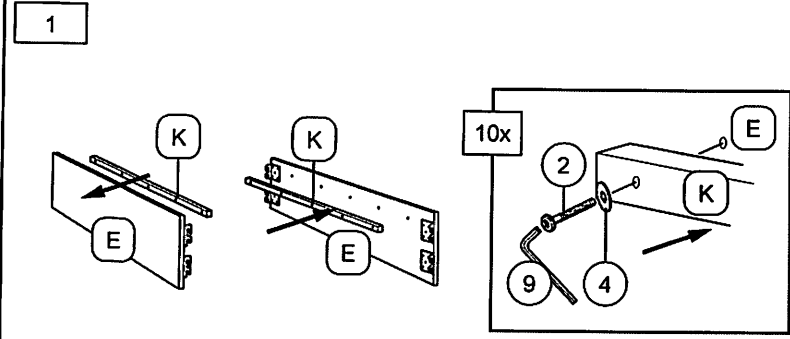

No	Part List	Qty
A	Headboard	1 pc
B	Footboard Cover	1 pc
C	Footboard Longside	2 pcs
D	Footboard shortside	2 pcs
E	Side Panel inside	2 pcs
F	Side Panel outside	2 pcs
G	Bed Slat	28 pcs
H	Bed Center Rail	1 pc
I	Bed Center Rail Support	3 pcs
J	Box Panel	5 pcs
K	Side Panel Bed Slat	4 pcs
L	Side Panel Cover	2 pcs

No	Hardware List	Qty
1	JCBC M8 x 16mm	32 pcs
2	JCBC M6 x 35mm	16 pcs
3	JCBC M6 x 20mm	4 pcs
4	Flat Washer M6	16 pcs
5	H-Nut M6	6 pcs
6	JCBC M6 x 16mm	56 pcs
7	L Bracket	28 pcs
8	Spanner 10mm	1 pc
9	Allen Key M4	1 pc
10	Allen Key M5	1 pc
11	Double Socket	14 pcs
12	Single Socket	28 pcs
13	Sping Bracket	7 pcs
14	CSK M4 x 16mm	42 pcs

Read this instruction carefully. Remove all wrapping material, staples and straps from the carton. See hardware and furniture part list for guidance. Be sure you have all wooden furniture parts on a clean and flat soft surface, such as a carpet or rug, to prevent from being scratched.

- CAUTION :**
1. Do not FULLY - TIGHTEN the nut or screw until all is ready to assemble.
 2. Do not OVER - TIGHTEN the nut or screw to avoid causing damages to the thread.
 3. Keep all hardware part out reach of children.

