

ASSEMBLY INSTRUCTION

MODEL : WC-3

STEP 9

Use Allen Key (N1) to tighten a Crosshead Screw (A17) & button the screw head with Crosshead Cover (Y).

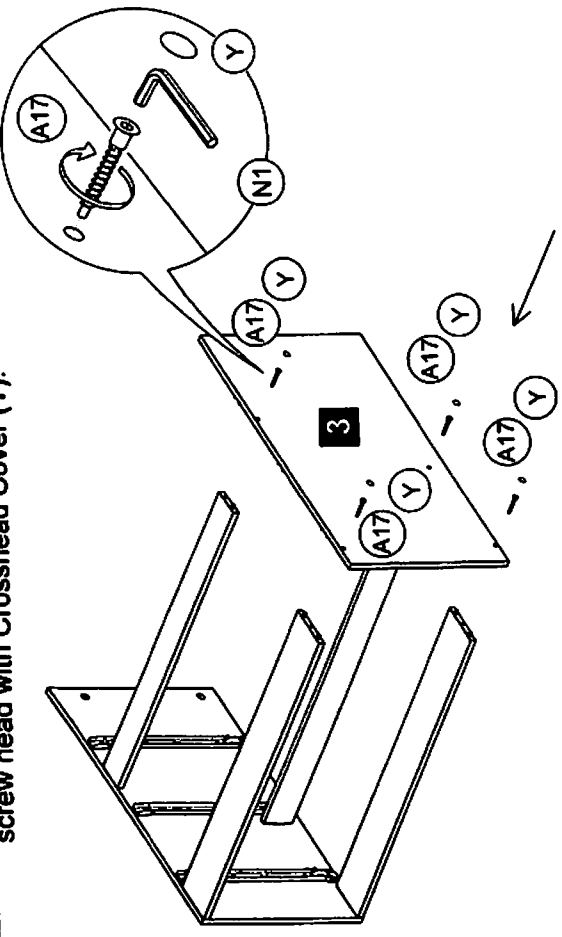

STEP 10

Attach panel no. 10 in right position and secure with Mini Fix 12mm (F1) at both side panel.

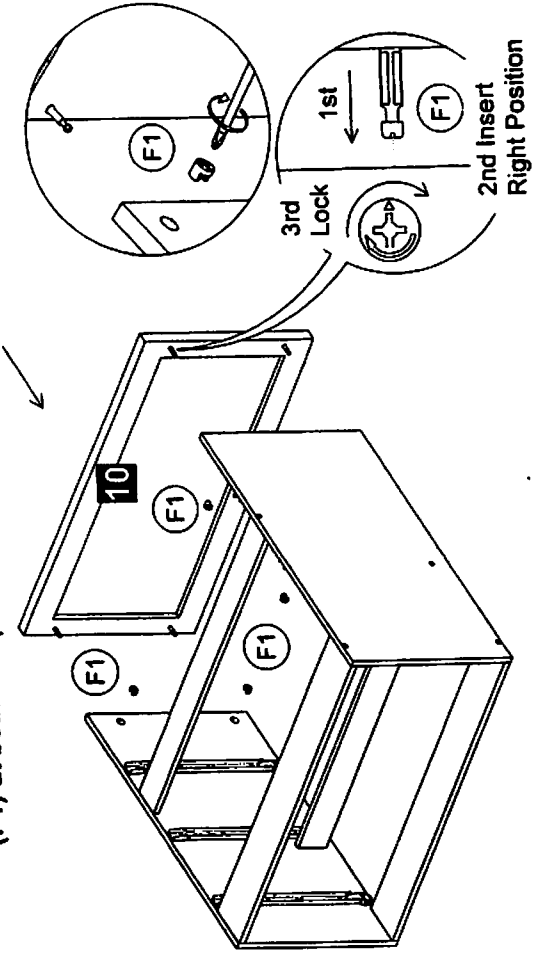

STEP 11

Screw the Plastic Leg L Shape (L2) at between panel no. 5 & both side panel. Assemble the back panel with secure by Nail (N2). Use screw (A2) to secure bottom panel.

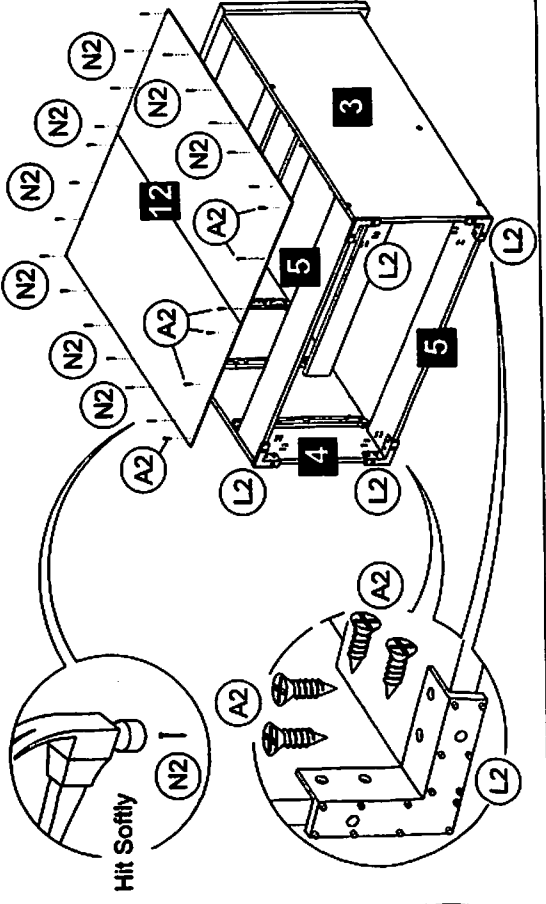

COMPLETE

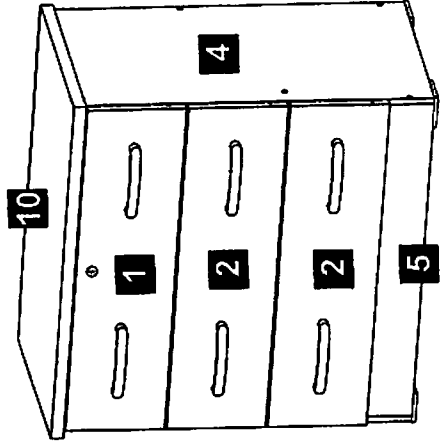

Insert a drawer

Stand up

ASSEMBLY INSTRUCTION

MODEL : WC-3

PAGE : 4/5

STEP 5

Use Screw (A1) to assemble the Drawer Metal Slide 350mm (M5) at both side drawer panel. Assemble 3 sets of drawer in repeated at step 5.

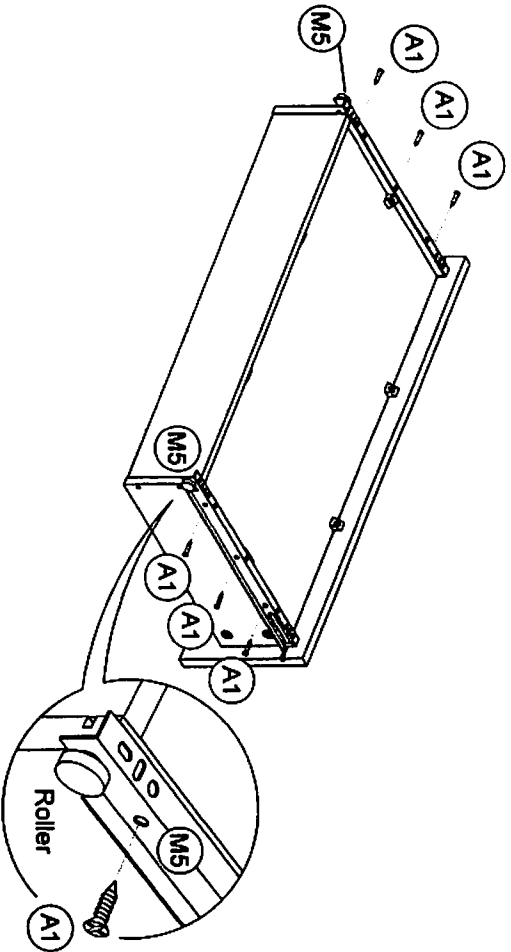

STEP 7

Use Screw (A1) to assemble left & right Drawer Metal Slide 350mm (M5) at marking hole panel no. 3 & 4.

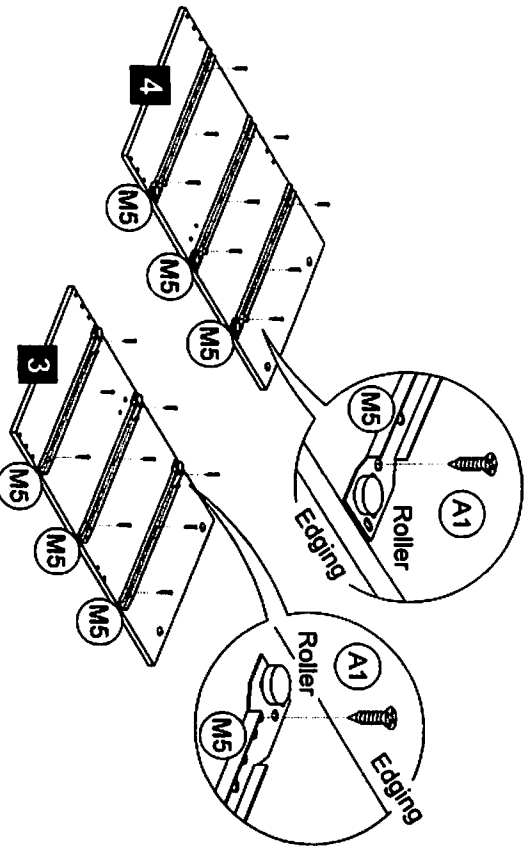

STEP 6

Screw the Mini Fix Bolt (F1) at marking hole panel no. 10 and use Screw (A3) to assemble the Square Lock L Bracket (C8) in right position. Then insert the Wood Dowel (D4) at both side panel no. 5 & 9.

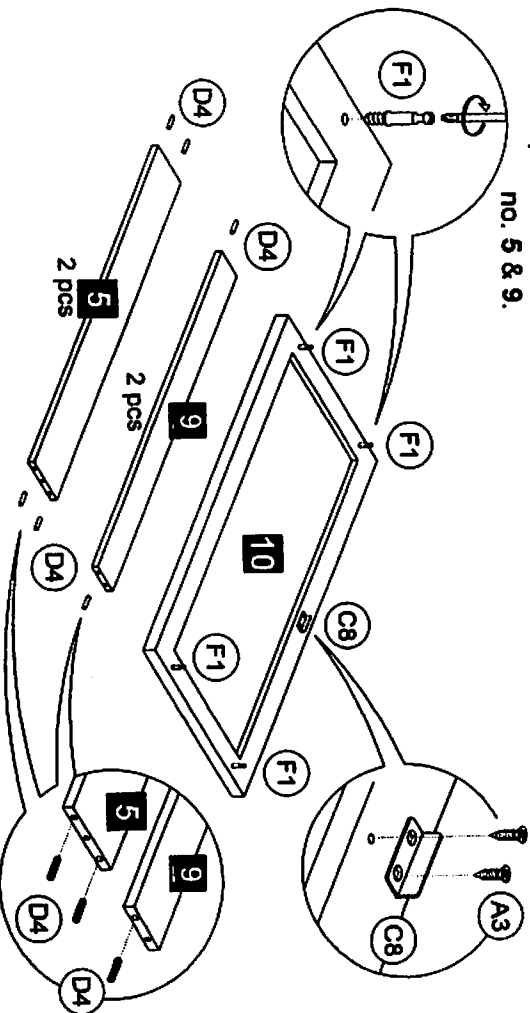

STEP 8

Use Allen Key (N1) to tighten a Crosshead Screw (A17) & button the screw head with Crosshead Cover (Y).

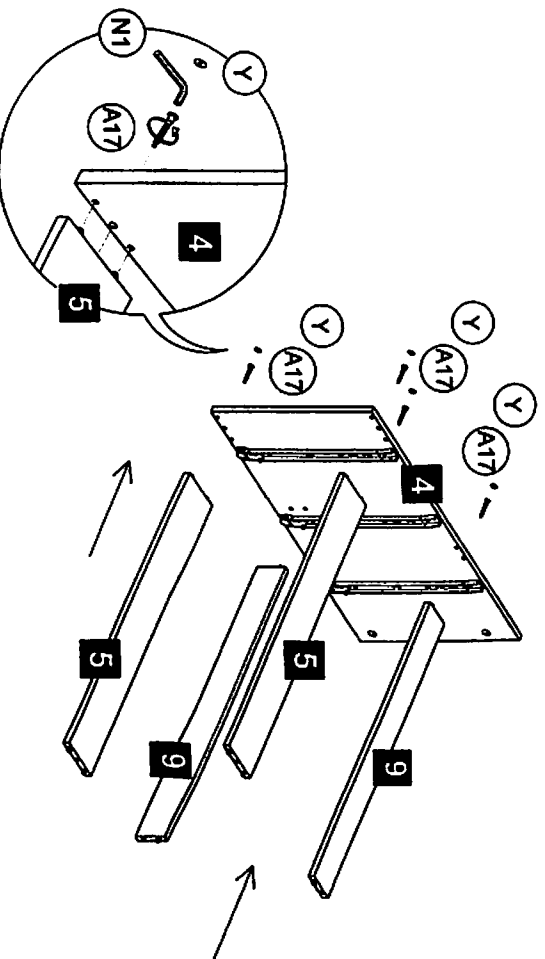

ASSEMBLY INSTRUCTION

STEP 1 Use Screw (A3) to screw the Square Lock Set (C5) at panel no. 1. Then fix the Mini Fix Bolt (F1) at panel no. 1 & 2 and use Screw (A7) to assemble the Handle (H6).

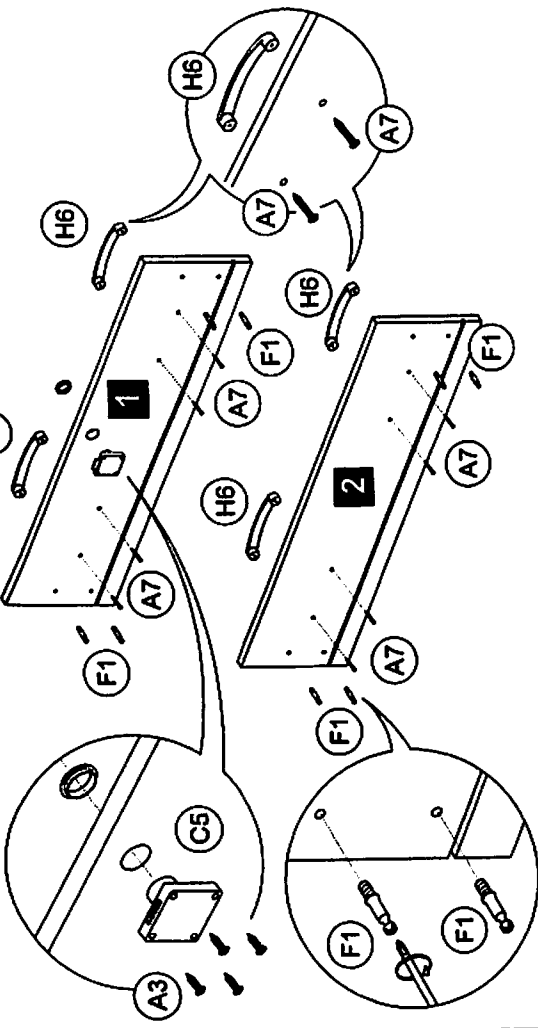

STEP 2 Assemble 3 sets of drawer in repeated at step 2.

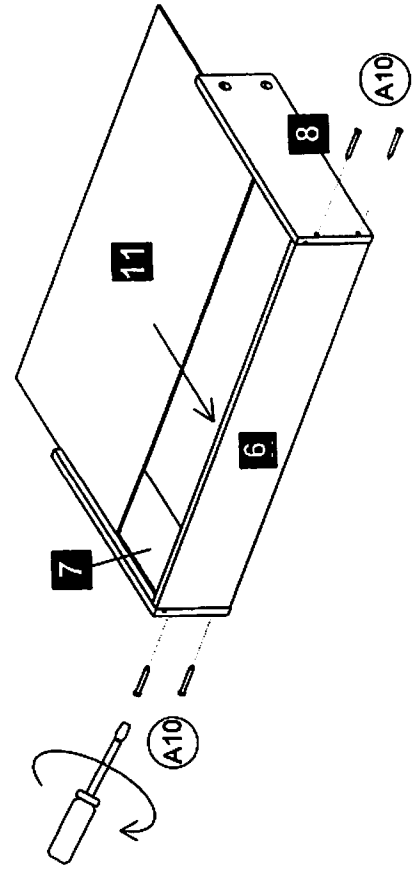

STEP 3 Attach the drawer head with secure by Mini Fix 12mm (F1). Assemble 3 sets of drawer in repeated at step 3.

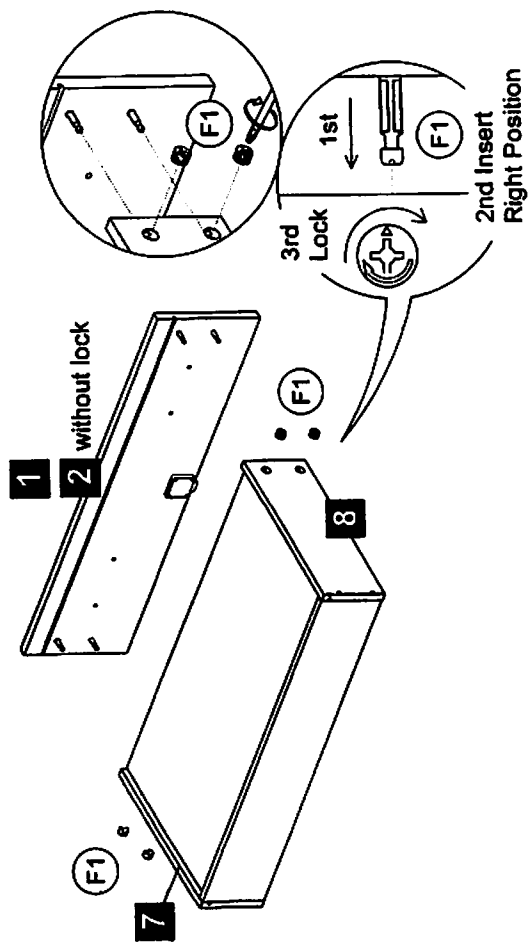

STEP 4 Use Screw (A2) to assemble the Single Plastic Cap (R2) to secure a bottom drawer panel. Assemble 3 sets of drawer in repeated at step 4.

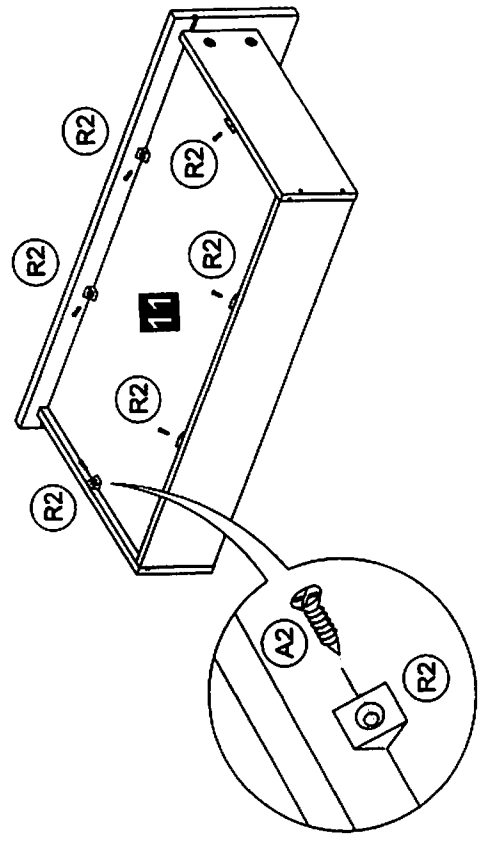

Reference Screw Size.

Place your screw on top to identify the size.

A1  Screw
m3.5 x 12mm

12mm

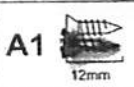
A1  Screw
m3.5 x 12mm

12mm

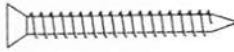
A7  Screw
m4 x 30mm

30mm

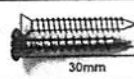
A7  Screw
m4 x 30mm

30mm

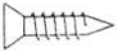
A2  Screw
m3.5 x 14mm

14mm

A2  Screw
m3.5 x 14mm

14mm

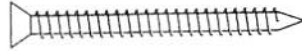
A10  Screw
m4 x 38mm

38mm

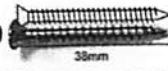
A10  Screw
m4 x 38mm

38mm

A3  Screw
m3.5 x 16mm

16mm

A3  Screw
m3.5 x 16mm

16mm

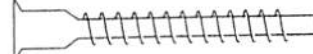
A17  Crosshead Screw
6.3 x 40mm

40mm

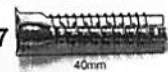
A17  Crosshead Screw
6.3 x 40mm









40mm









Before you begin, please follow assembly instruction carefully, then follow step by step.

Read instruction carefully. See furniture Parts List and Hardware List for guidance. Be sure you have all parts before you start assembling. Place and assemble furniture on a clean flat soft surface, such as carpet, rug or carton to prevent being scratched.

Reminder :

Please ensure that all surface and edges with colours / laminations are facing forward / outward.

HARDWARE LIST		QTY
A1		36
A2		40
A3		6
A7		12
A10		12
A17		8
C5		1 set
C8		1

D4		Wood Dowel 6 x 25mm	12
F1		Mini Fix 12mm	16 sets
H6		Handle 128mm (Silver)	6
L2		Plastic Leg L Shape	4
M5		Drawer Metal Slide 350mm	3 sets
N1		Allen Key	1
N2		Nail	14
R2		Single Plastic Cap	18
Y		Crosshead Cover	8

Each pack have contain different type hardware and size of screw for easy assemble. Please refer to page 2, check a screw size.

CAUTION

MATERIAL USE LAMINATED PARTICLE BOARD, TO CLEAN USE SOFT, DRY CLOTH. DO NOT USE DETERGENT OR CHEMICAL AVOID CONTACT WITH WATER AND DIRECT SUNLIGHT. TO BE ASSEMBLED ON A SOFT, DRY, CLEAN SMOOTH SURFACE.



USE OF POWER TOOLS TO ASSEMBLE THIS PRODUCT WILL INVALIDATE ANY CLAIM AND MAY DAMAGE THIS PRODUCT MAKING IT UNSAFE.

