

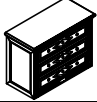





# Assembly Instructions

## ITEM NO.:71148

Thank you for purchasing this quality product. Be sure to check all packing material carefully for small parts that may have come loose inside the carton during shipment. (Note: Loosely thread all screws/bolts first. Once the item is assembled then completely tighten.)

PARTS LIST:				HARDWARE LIST				
NO.	Description	Sketch	Quantity	NO.	Sketch	Description	Size	Quantity
A	Top		1pc	C		Blots	Ø5/16*1-3/4"	8pcs
B	Leg		4pcs	D		Flast washer	Ø5/16"	8pcs
				E		Look washer	Ø5/16**3/4"	8pcs
				F		Allen wrench	M4	1pc

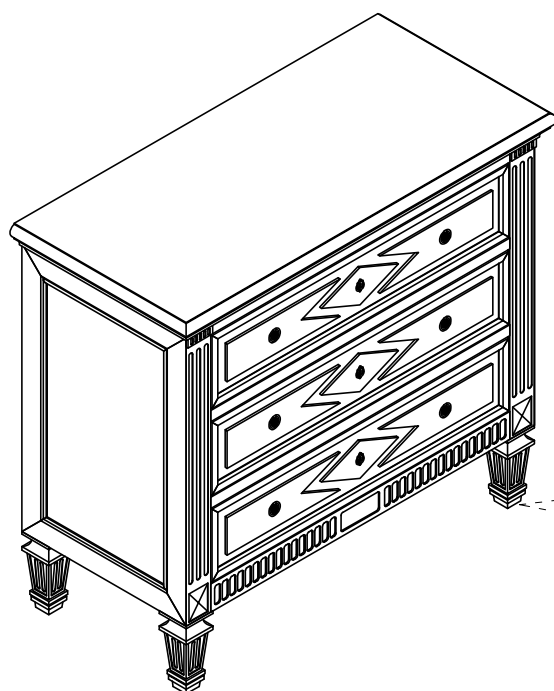
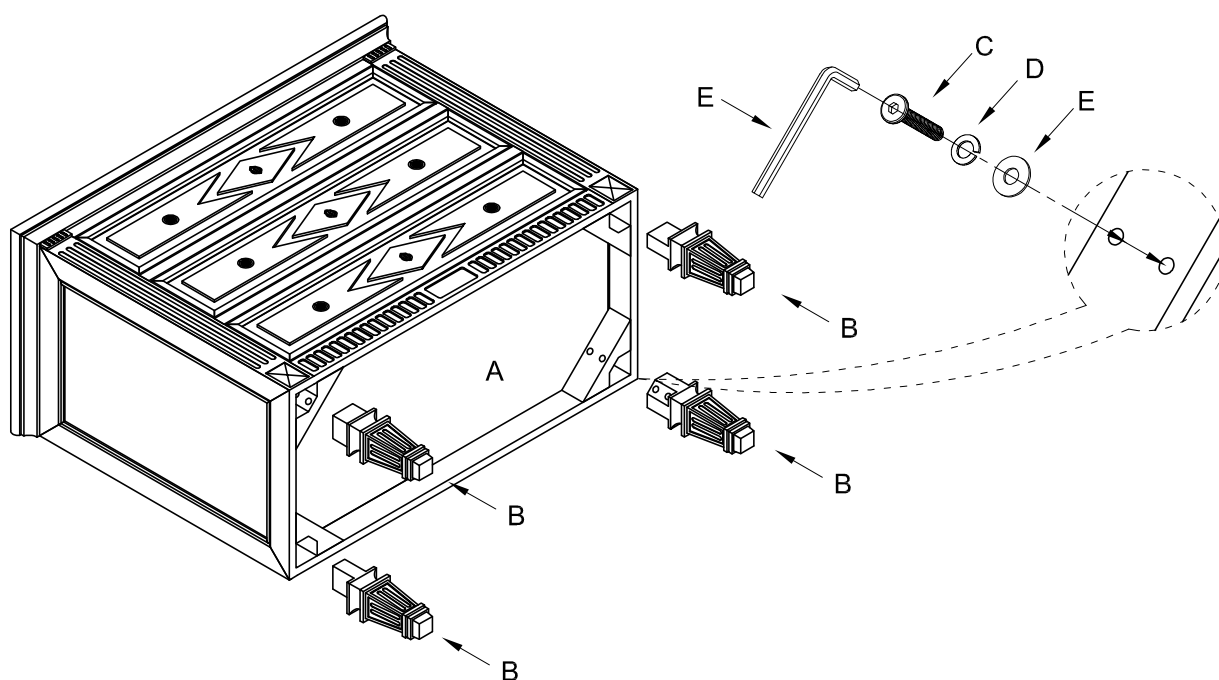

Tips: for a aligning doors:

Tip A: Sometimes the doors will not line up because of an uneven floor surface the furniture reats on. In that case, try adjusting the levelers found on the botton of each foot to aid in corecting.

Adjustable leveler