



ASSEMBLY INSTRUCTION





MODEL : BELLAGIO
DESCRIPTION : DRESSER

Thank you for purchasing this quality product. Be sure to check all packing material carefully for small parts which may have loose inside the carton during shipment. Identify and count all parts and compare with the parts list below.

PART LIST#

NO	DRAWING	DESCRIPTION	QTY
A		Dresser	1pc
B		Bun Foot	4pcs
C		Metal Leg	2pcs

HARDWARE LIST#

NO	NAME	PART	QTY
1	Allen Key		1pc
2	JCBC / Boulon - M6 x 20mm		4pcs
3	M6 Spring Washer		4pcs
4	M6 Flat Washer		4pcs

Bun Foot cover /
Couverture des
pieds

Remove Bun Foot cover
before assemble.

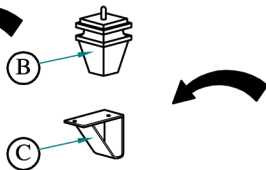

Remove Bun Foot carton
located in the drawer of the
casegood. Remove and
unwrap each foot.

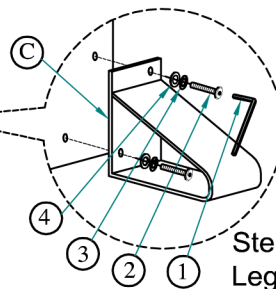
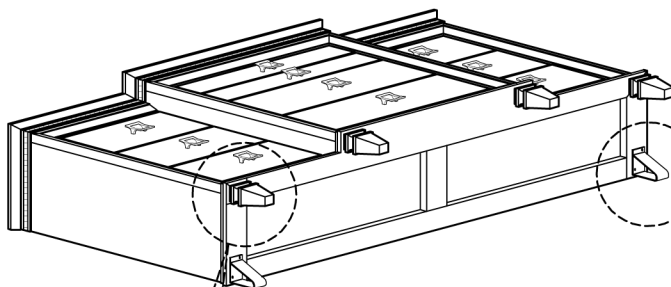
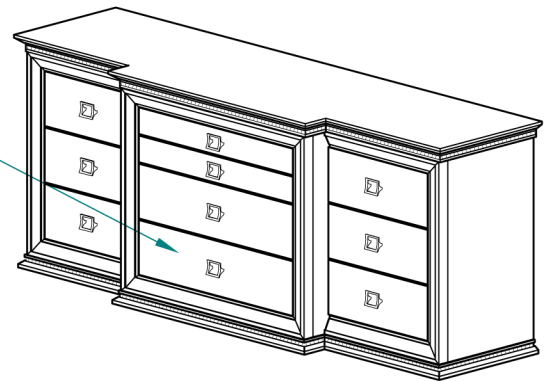

Step 2 : Secure the (C) Metal
Leg to the bottom of (A) Dresser
as a diagram shown.

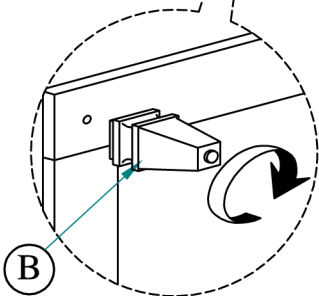



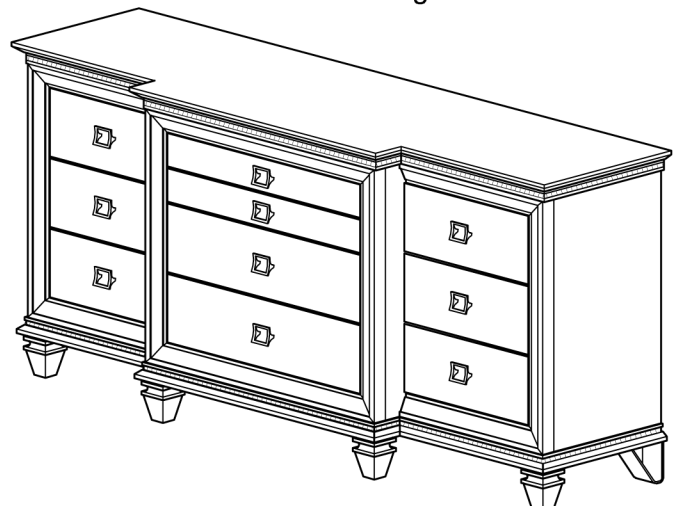

Step 1 : Secure the (B) Bun Foot
to the bottom of (A) Dresser
as a diagram shown.



Assembly completed

HARDWARE LIST

NO	NAME	PART	QTY
A	Bracket		2pcs
B	Tie Wrap		1pc
C	Long Screw		1pc
D	Short Screw		1pc

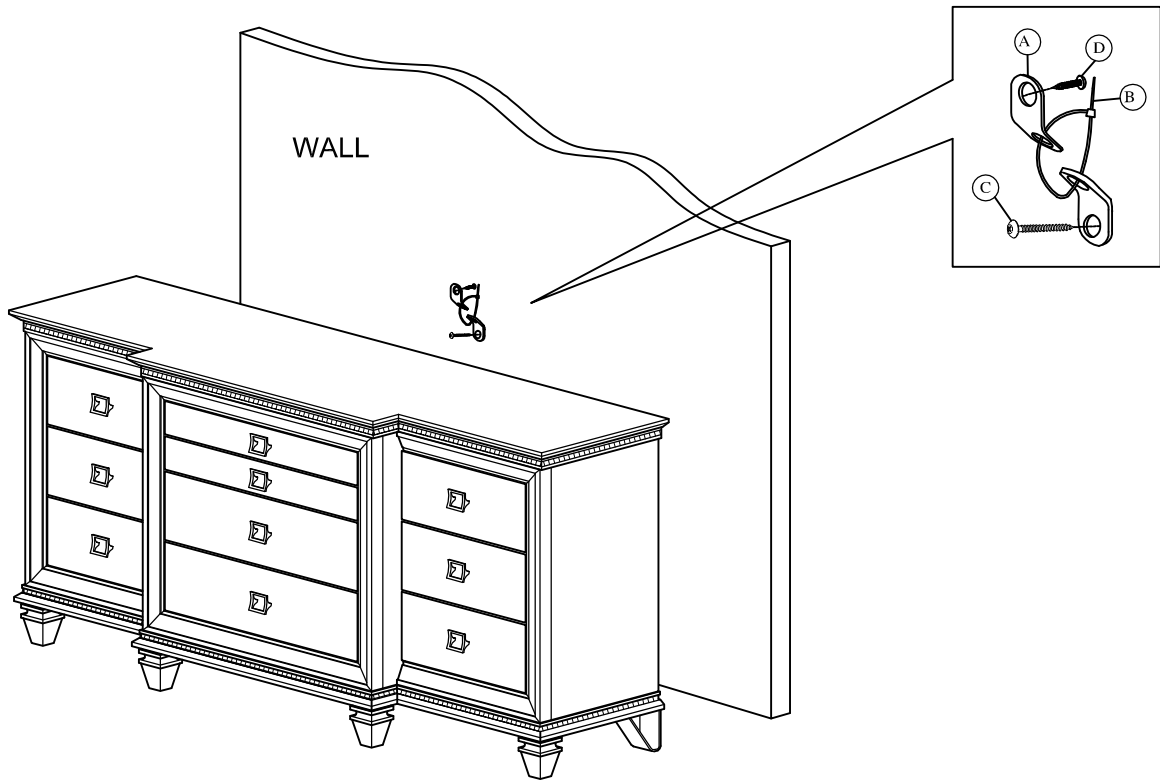

Assembly completed