

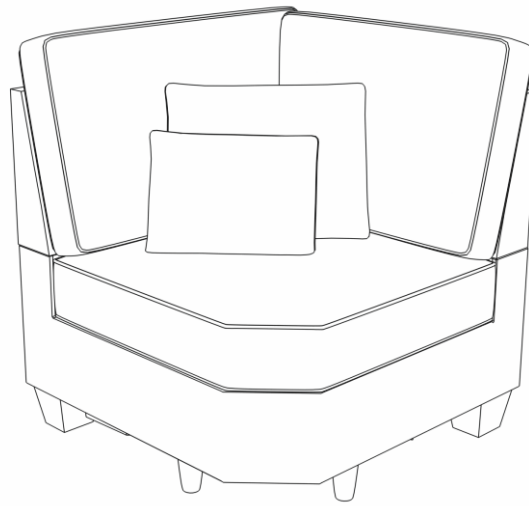







ASSEMBLY INSTRUCTION





ITEM NO.:D6014-C D6015-C D6115-C



PARTS LIST

				
A x1	B x1	C x1	D x1	E x1
				
F x1	G x1	H Leg x3		

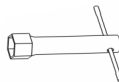
HARDWARE LIST

				
1 Bolt x4	2 Nut x4	3 Washer x4	4 Wrench x1	5 SUPPORT Legs x2

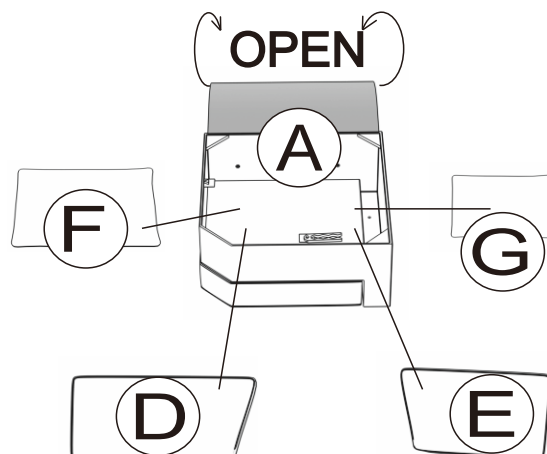

Step1

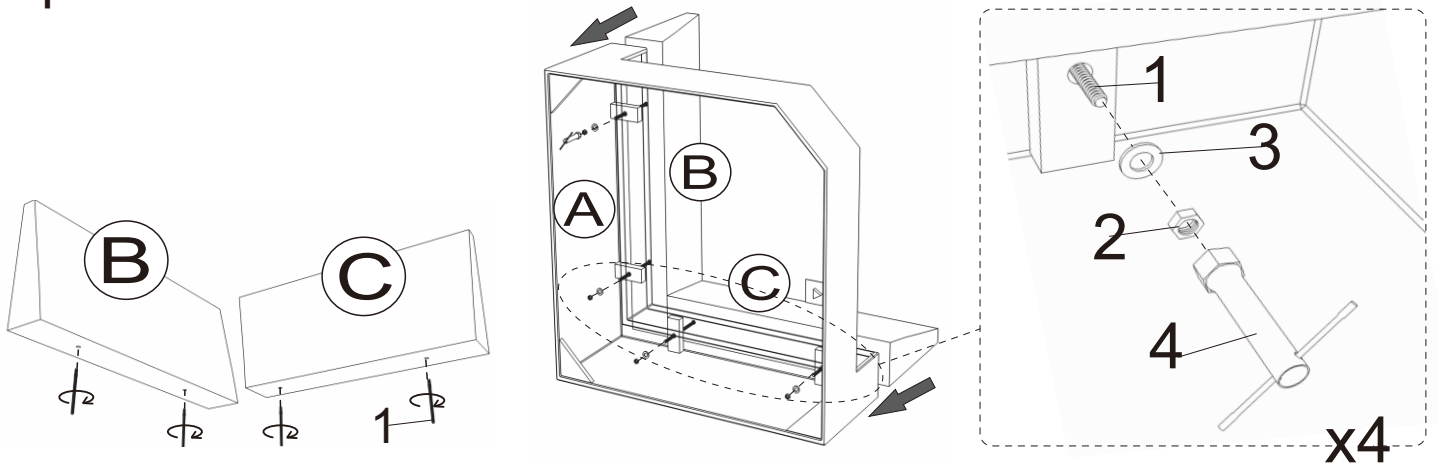

Step2

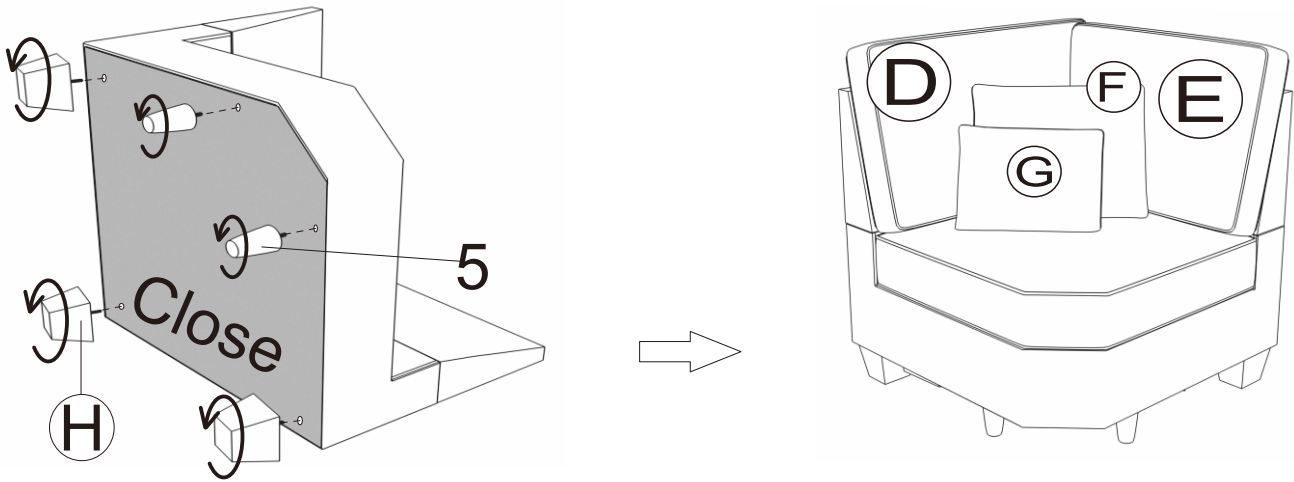

Launch the bottom connector.

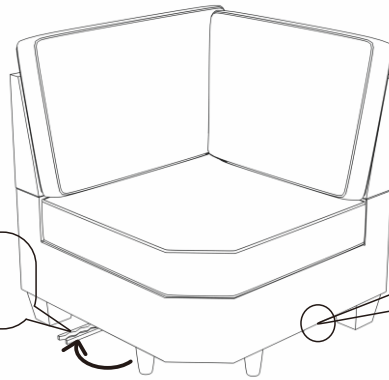

this is the bottom connector.



Can be combined with the same series of products.

