

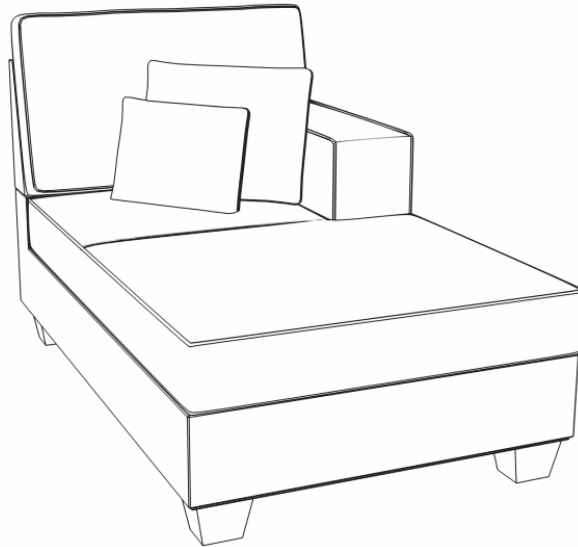

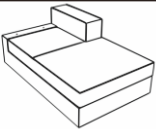



ASSEMBLY INSTRUCTION



ITEM NO.:D6014-S D6015-S D6115-S



PARTS LIST

				
A x1	B x1	C x1	D x1	E x1
				
F Leg x4	G SUPPORT Legs x1			

HARDWARE LIST

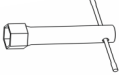
				
1 Bolt x2	2 Nut x2	3 Washer x2	4 Wrench x1	

Step1

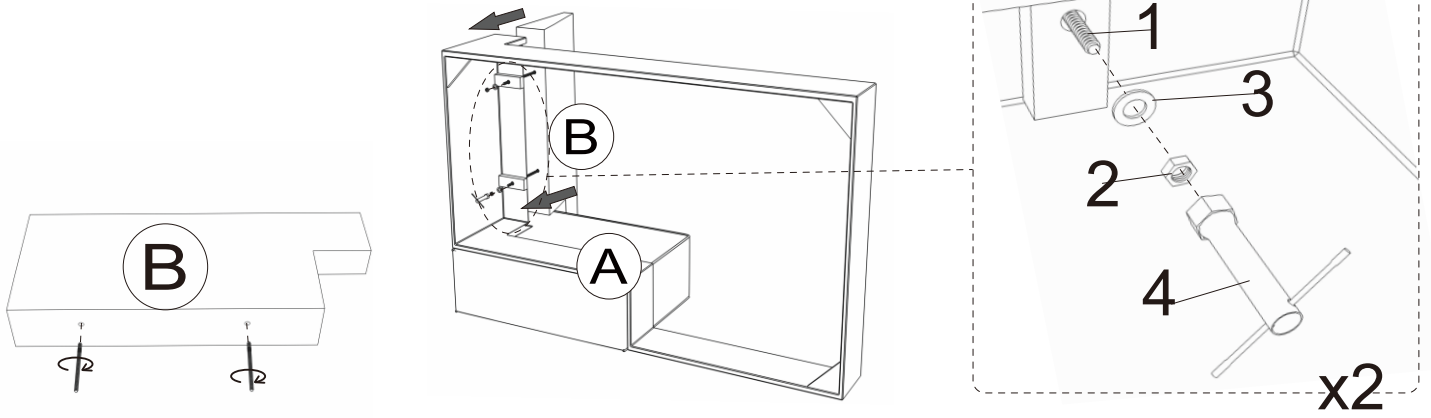

Step2

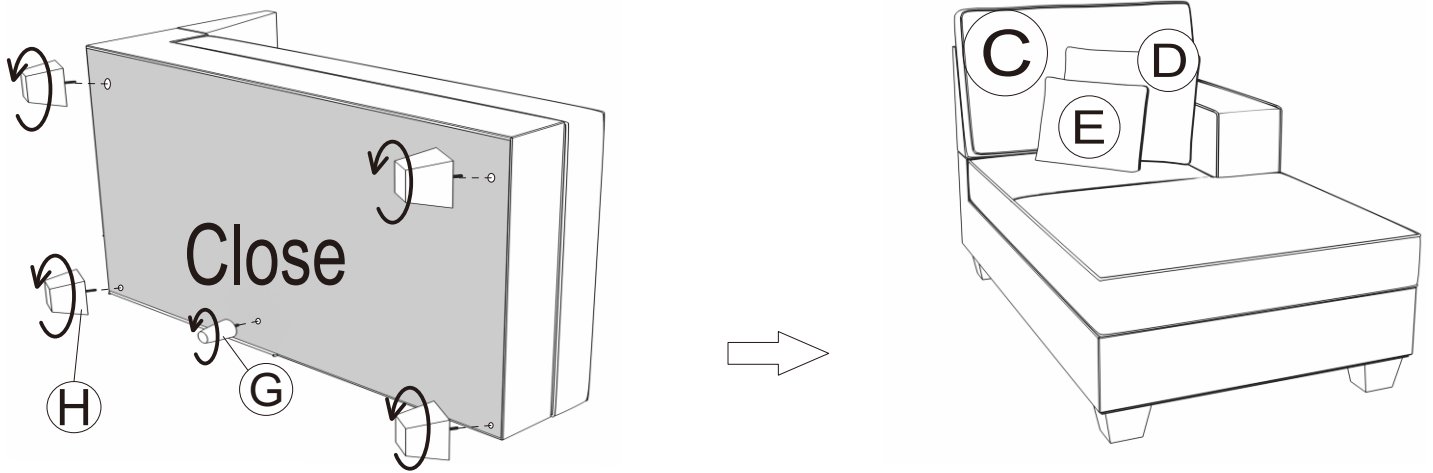

Launch the bottom connector.

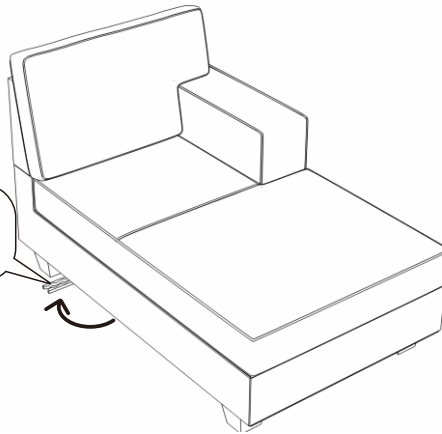

Can be combined with the same series of products.

