



Best Master Furniture™
The Imported Furniture Specialist

MODEL : C126- CHEST

ASSEMBLY INSTRUCTIONS

Hours of Operation
MON-FRI 8:00AM - 4:00PM (PT)

TOOLS REQUIRED



Screwdriver
(Not included)

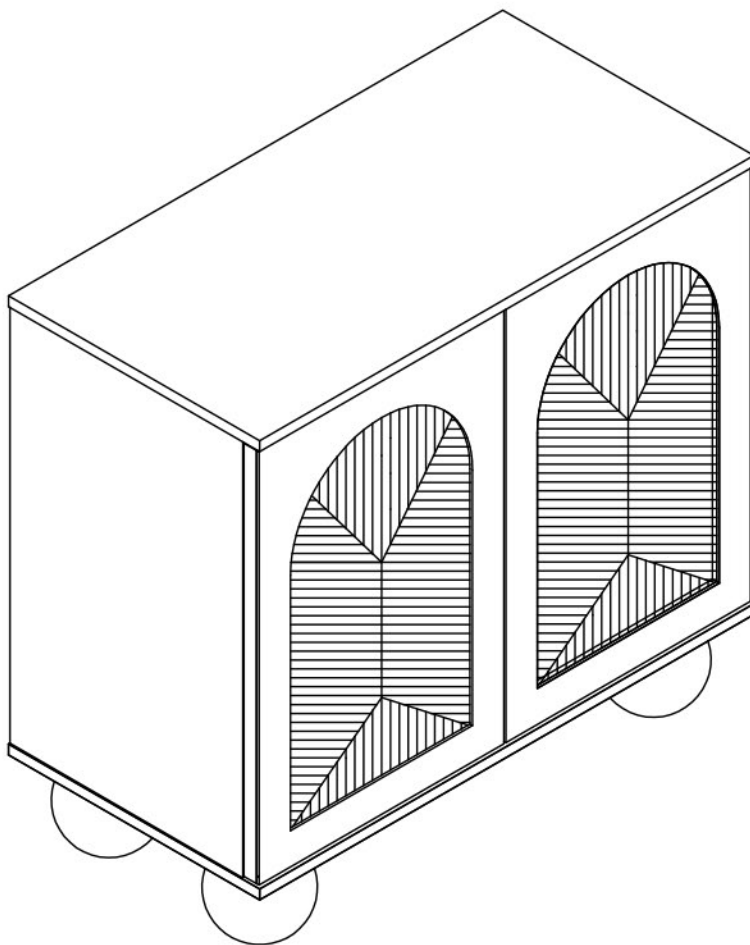

2 - People

Enjoying this product? We'd love your 5-star review!
If you have any issues, our support team is happy to help.



Best Master Furniture™
The Imported Furniture Specialist

Thank you for your purchase

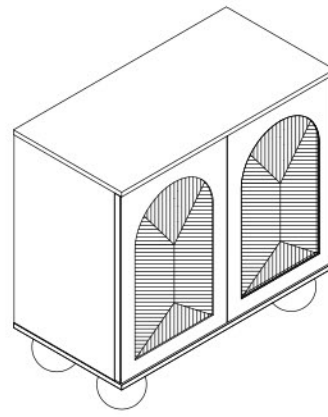

Monday-Friday
8:00AM - 4:00PM PT



@Email
inquiries@bestmasterfurnitures.com



www.bestmasterfurnitures.com



CHECK BEFORE STARTING

Are you missing anything?

Please double check all hardware and parts match the assembly guide before putting the product together. If damaged, we suggest you put the item back in the box and start your claim or return

Should we send any replacements?

If there are any manufacturer defects or missing pieces please contact us for replacements. If purchased online, please contact the website of where you purchased it from, DIRECTLY

IMPORTANT INFO before assembly:

If there's a problem with the parts do not attempt to assemble the product

- Place all parts on a clean and smooth surface such as a rug/carpet to avoid parts from being scratched
- When tightening screws to product do not overtighten until product is fully setup
- If product is too heavy for a single person to carry do not attempt and ask for assistance
- DO NOT DRAG or PUSH item to desired location. Must be carried when moving
- If item is not working as intended please review the assembly guide to see if any steps were missed or incorrectly built. If there's a problem with part please contact seller for additional assistance
- Please keep all hardware and small parts away from pets/infants
- Please wear gloves or protective gear to protect from getting cuts
- It is normal for new furniture to have an off gassing smell. Please air out furniture near a window for a few hours or a day before placing it in its desired location
- All products may have a slight color and texture variation due to different shipments, natural materials, screen- resolutions, or lighting in home. Images are rendered by different devices or websites



Best Master Furniture™
The Imported Furniture Specialist

Model : C126-CHEST

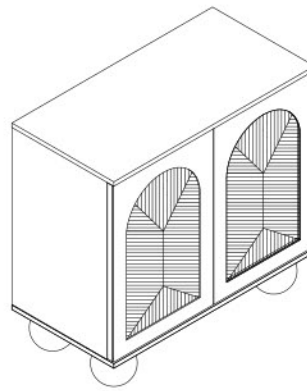

PARTS

Ⓐ x 1

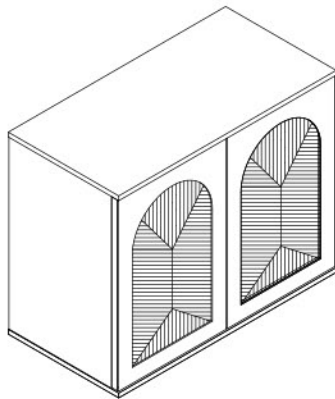



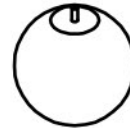

BODY

Ⓑ x 4

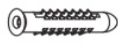

LEGS

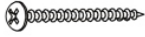
HARDWARE

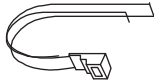
No.	OUTLOOK	DESC	QTY
1 Anti Tip Kit		Plastic Anchor	1 PC
		Metal Bracket	2 PCS
		Long screw M4 x 50	1 PC
		Short screw M4 x 15	1 PC
		Plastic Strap	1 PC

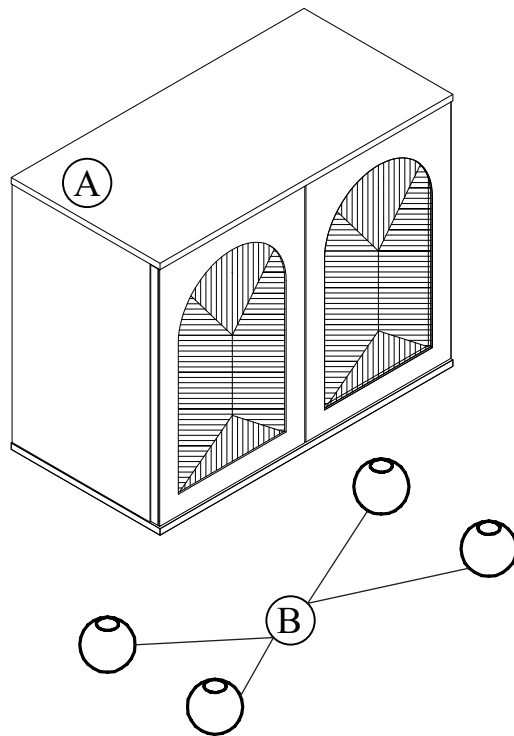

PARTS

check that you've received all parts listed below

BOX : 1

Ⓐ x 1

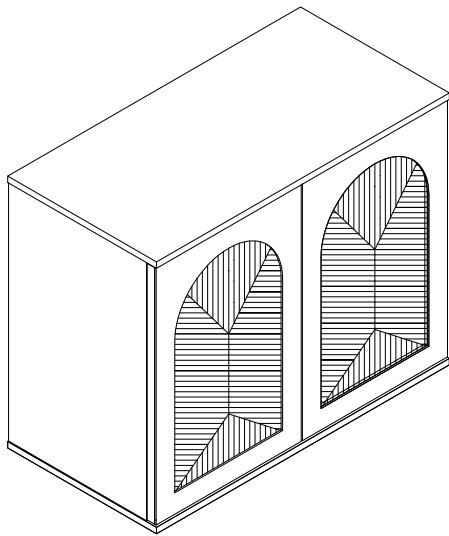

Ⓑ x 4

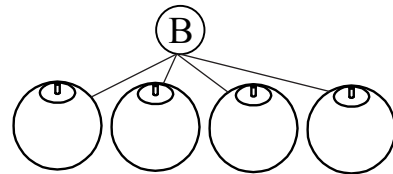
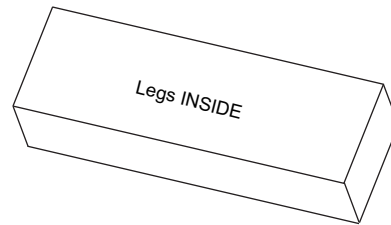

STEP 1

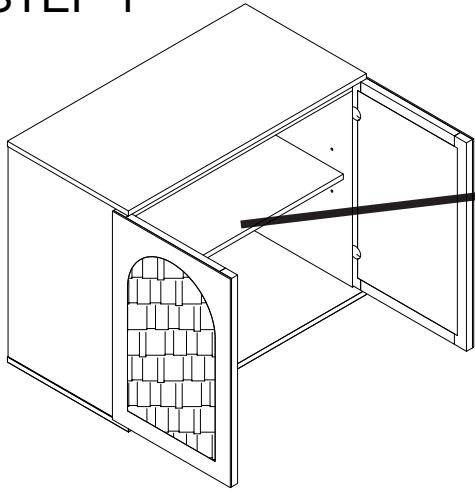

Open this Box "LEG INSIDE" in the Chest
Legs (B) 4pcs

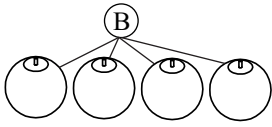
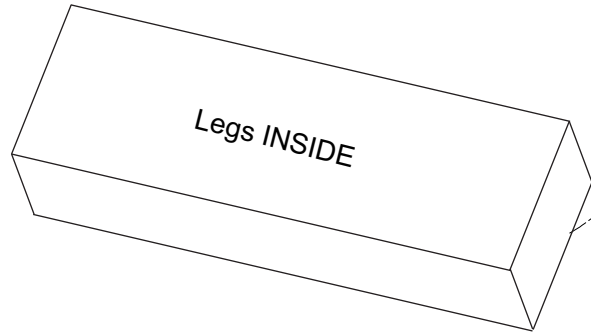

STEP 2

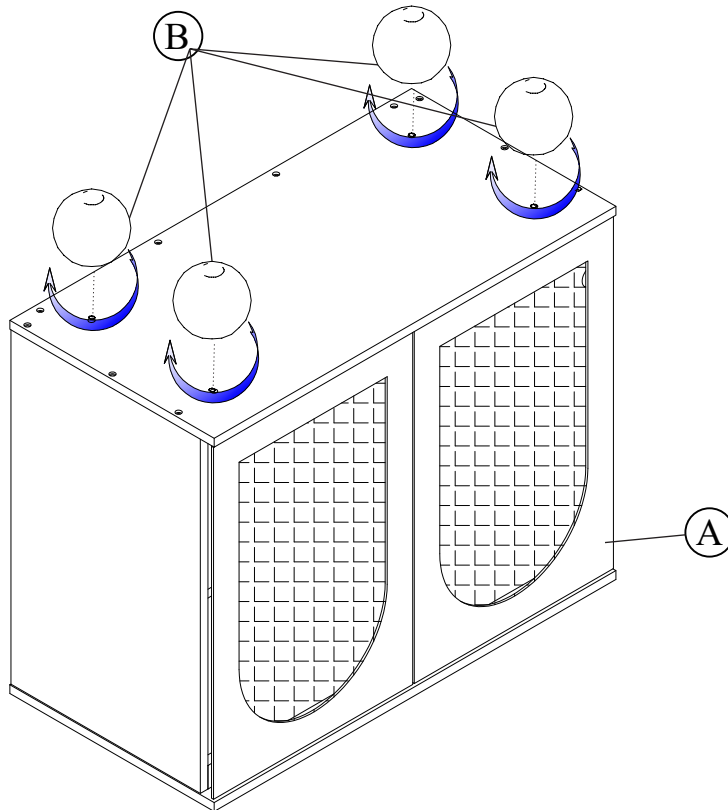

STEP 3

Is your cabinet door looking crooked or unevenly spaced?

If you're still having trouble lining everything up, your next step should be to try to adjust the feet slightly to square up the cabinet and doors. Follow the instructions below:

If the right door appears to be hanging low, you can adjust the adjustable leveler on the front right until the door is better aligned.

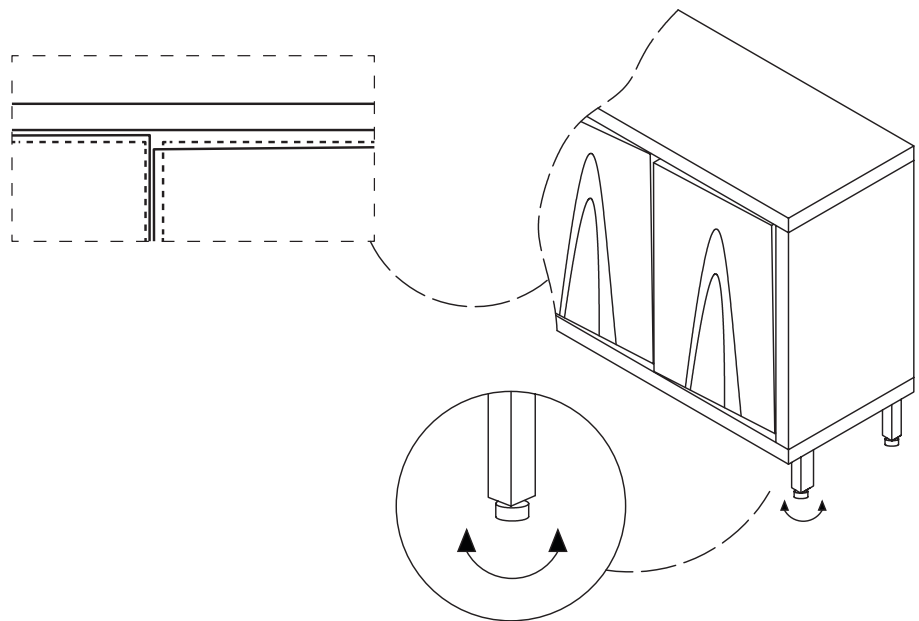



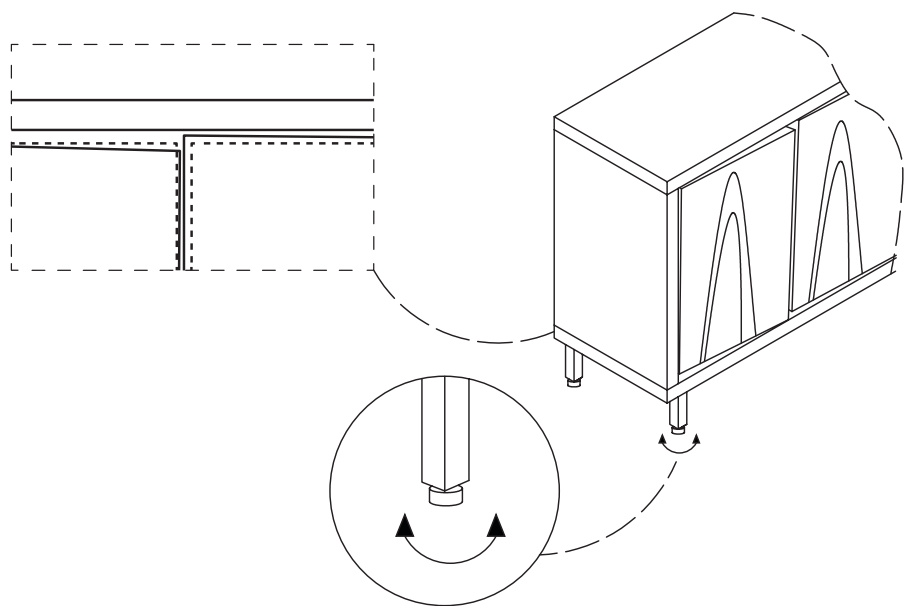

If the left door appears to be hanging low, you can adjust the adjustable leveler on the front left until the door is better aligned.

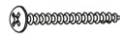

STEP 4

3

 1 pc	 2 pcs	 M4 x 40 1 pcs	 M4 x 15 1 pc	 1 pc
---	---	---	--	---



Screwdriver
(Not included)

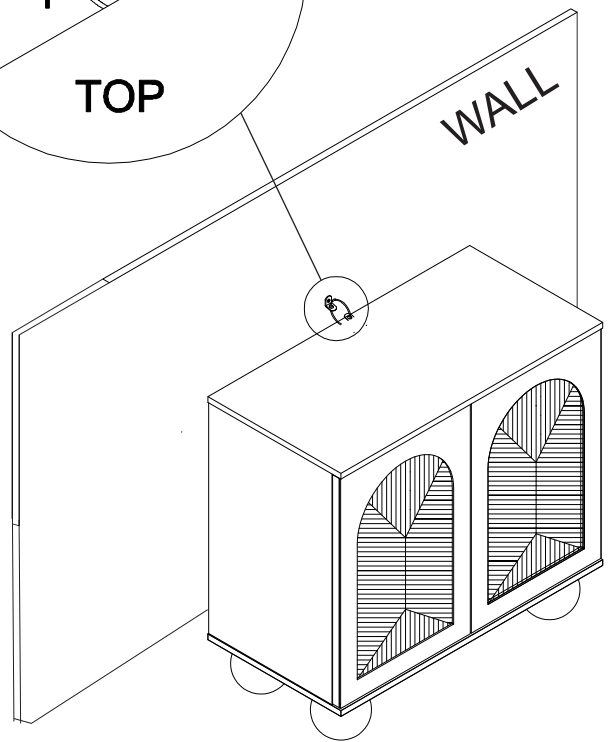
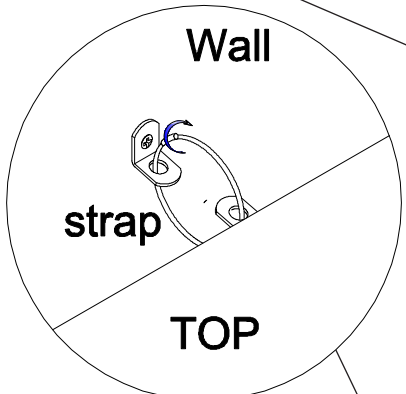
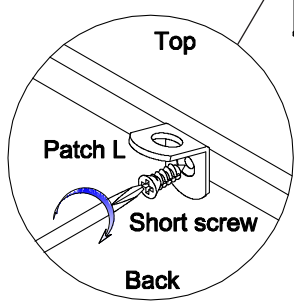
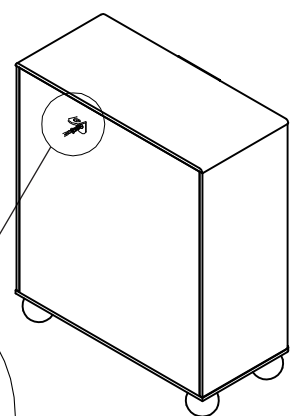
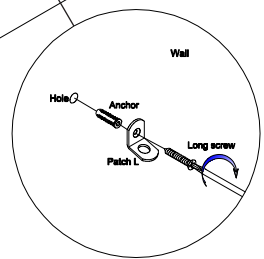
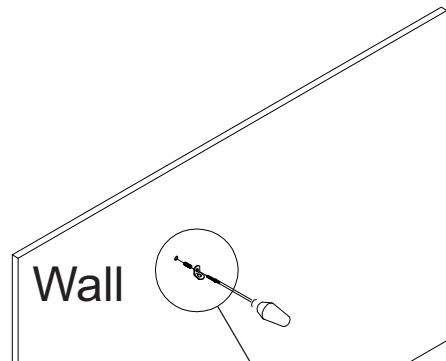

Finish