











Assembly Instructions

Caution: You must read this before you proceed

Care & Maintenance

	<ul style="list-style-type: none">● Not for commercial use. For residential use only.
	<ul style="list-style-type: none">● Furniture may scratch floors. We recommend using furniture pads to protect your floors.
	<ul style="list-style-type: none">● Do not put hot items directly on furniture surface.
	<ul style="list-style-type: none">● Do not clean furniture with harsh cleansers or polish.
	<ul style="list-style-type: none">● Do not place furniture under direct sunlight.
	<ul style="list-style-type: none">● Do not place furniture near heating or cooling vents.
	<ul style="list-style-type: none">● Do not write on furniture without a padded barrier to protect the surface.
	<ul style="list-style-type: none">● Do not place furniture outside . For indoor use only.
	<ul style="list-style-type: none">● Stains may be removed with mild soap solution and damp cloth.
	<ul style="list-style-type: none">● Children should not climb or jump on the furniture.
	<ul style="list-style-type: none">● Dust and pick-up spills using a clean, non-colored, lint-free cloth.

Please look in the magic tape pouch for hardware packs and legs

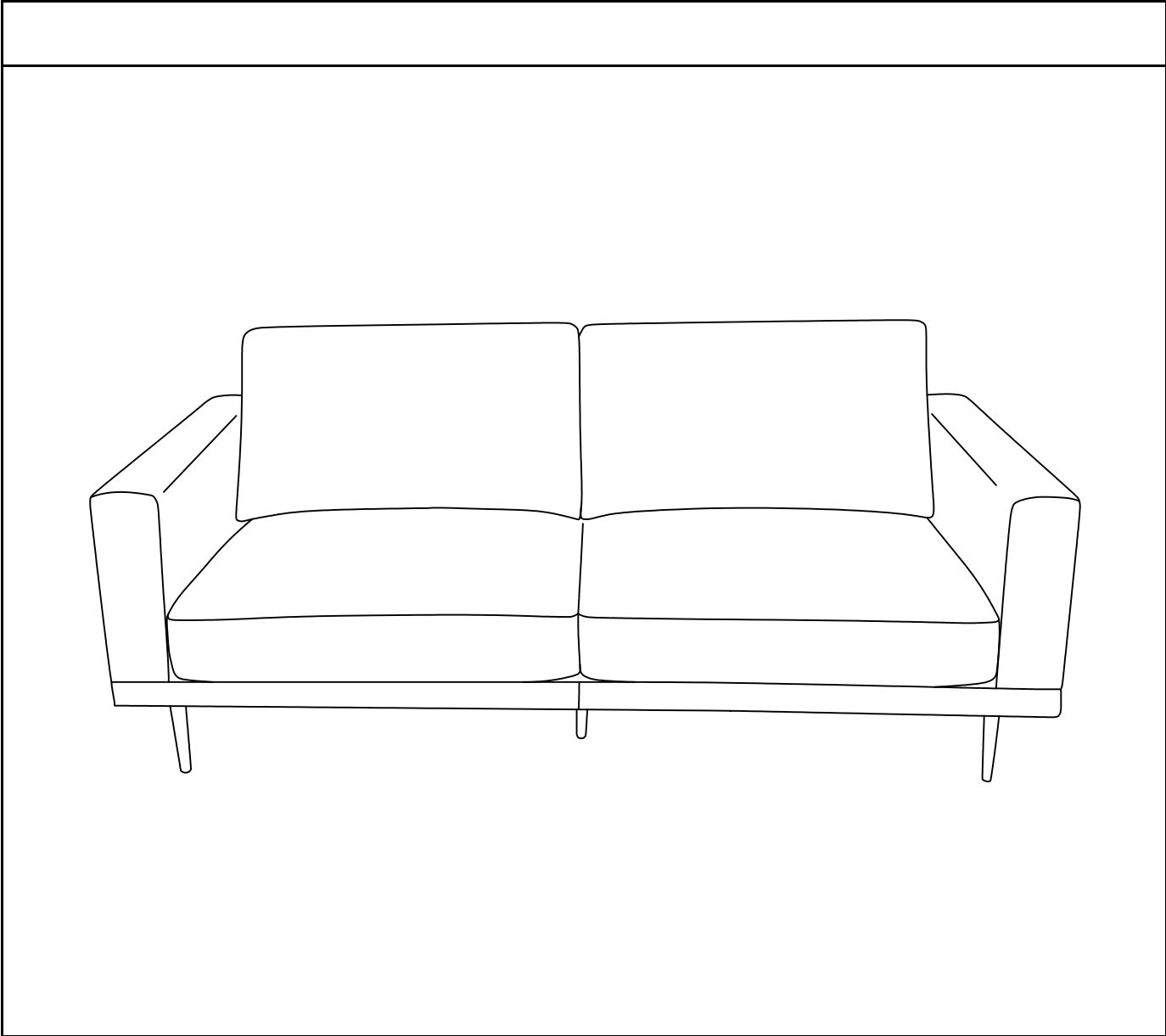

Alle Teile und Hardware

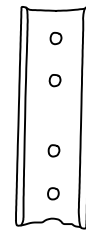
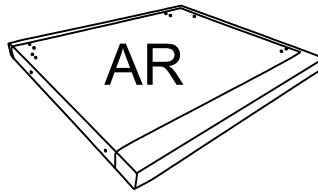
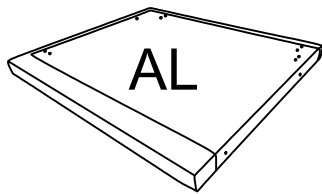

①*2

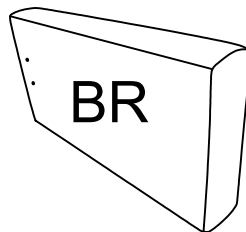
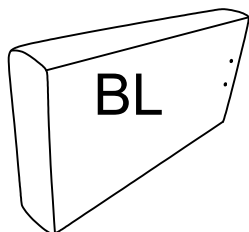

②*2

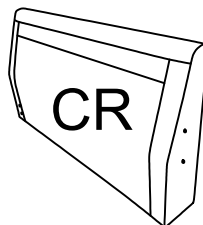
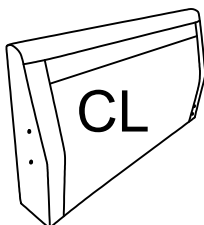

③*2



④*6

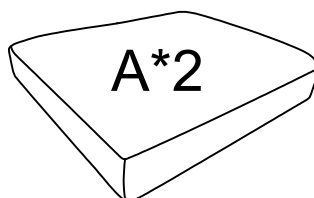
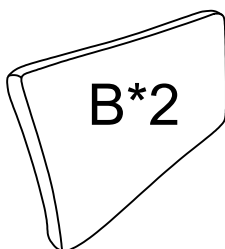

⑤*40
M6*15

⑥*14
M6*40

⑦*2
M8*70

⑧*16

⑨

⑩



- Read instructions, cover to cover-



- Have 2 adults on hand for assembly-



- Do not assemble on flooring or carpet-



- Assemble on a clean non-marring surface (packing foam)-



- Save all packaging until finished-

Assembly Steps

OVERVIEW

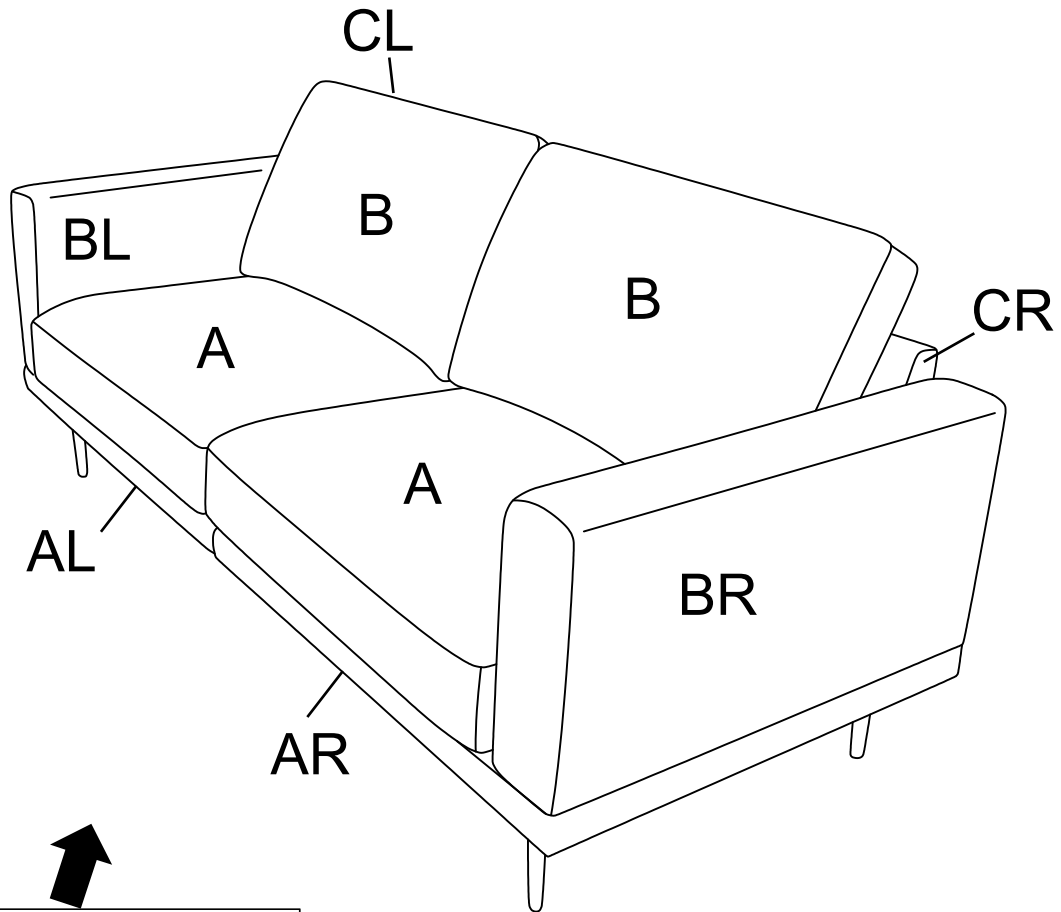

FRONT FACING

This Chair has multiple parts and may require up to 60 minutes to assemble. To give you an overview of the Chair parts, the above picture is to help you put the various parts into perspective.

Note: It is recommended that you have an adult partner to assist during the entire assembly process.

Step 1

② x2

⑤ x4

⑨ x1

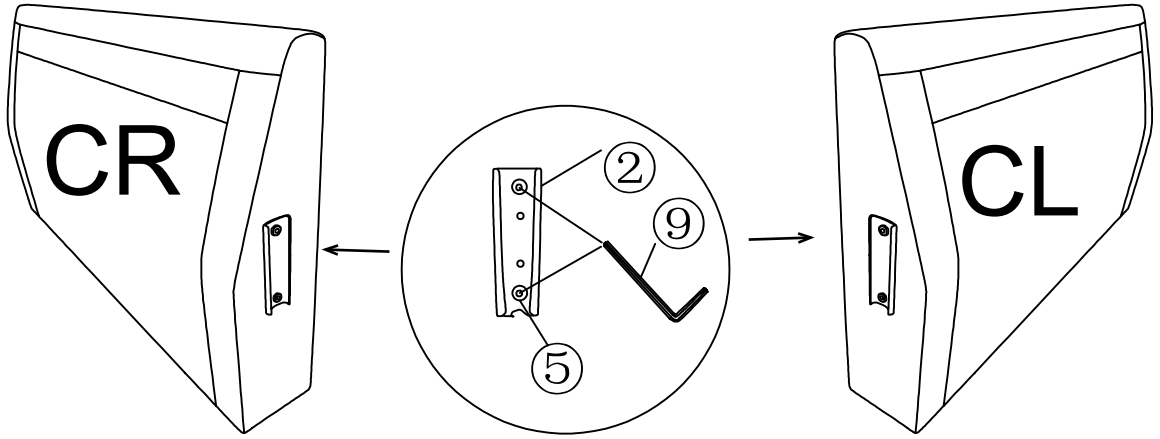

Step 2

① x2

⑤ x4

⑨ x1

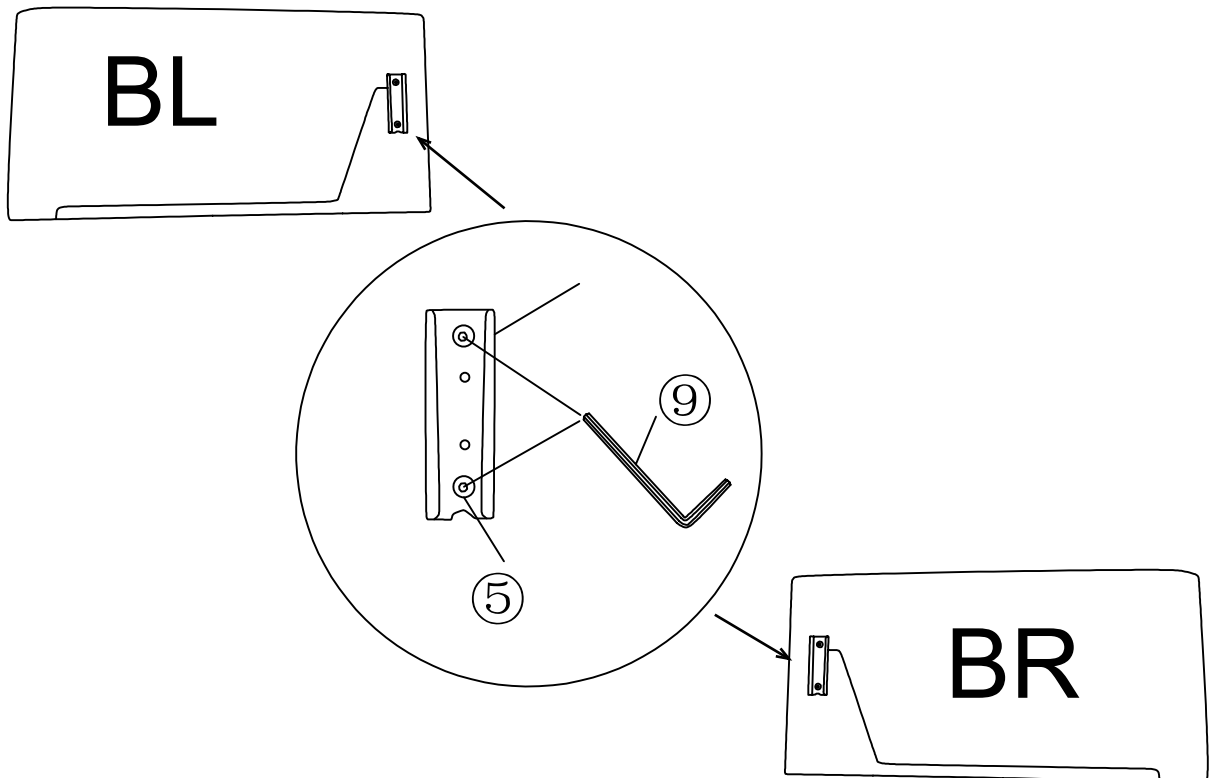

Step 3

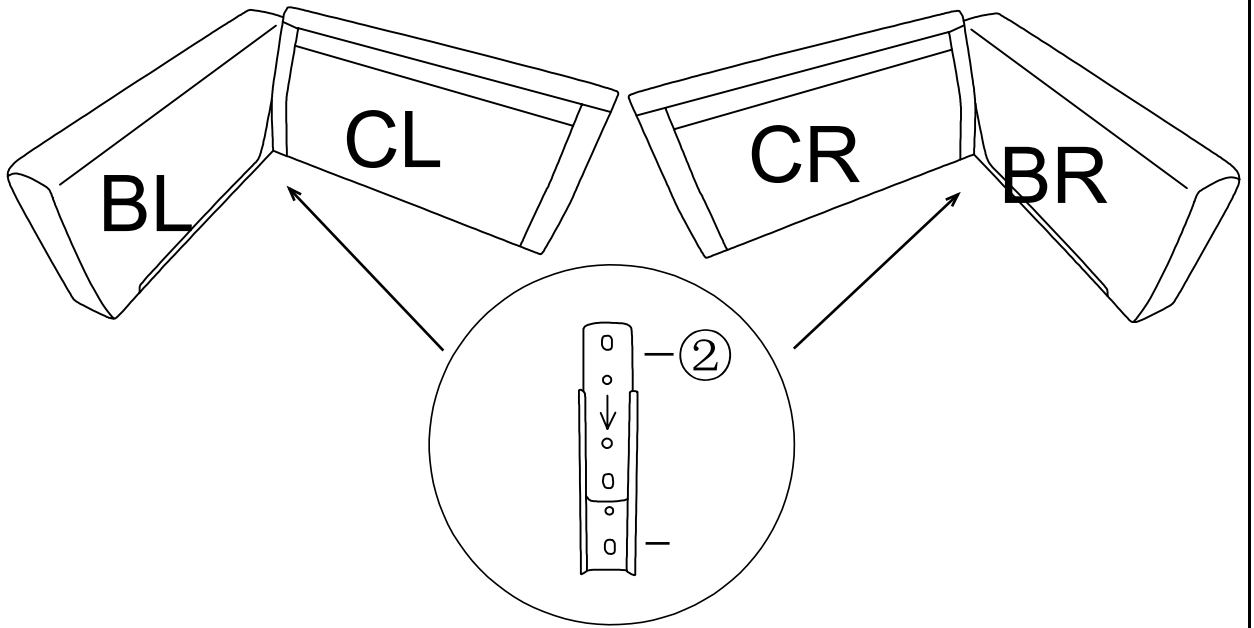

Step 4

⑨ x1

⑥ x14

⑧ x14

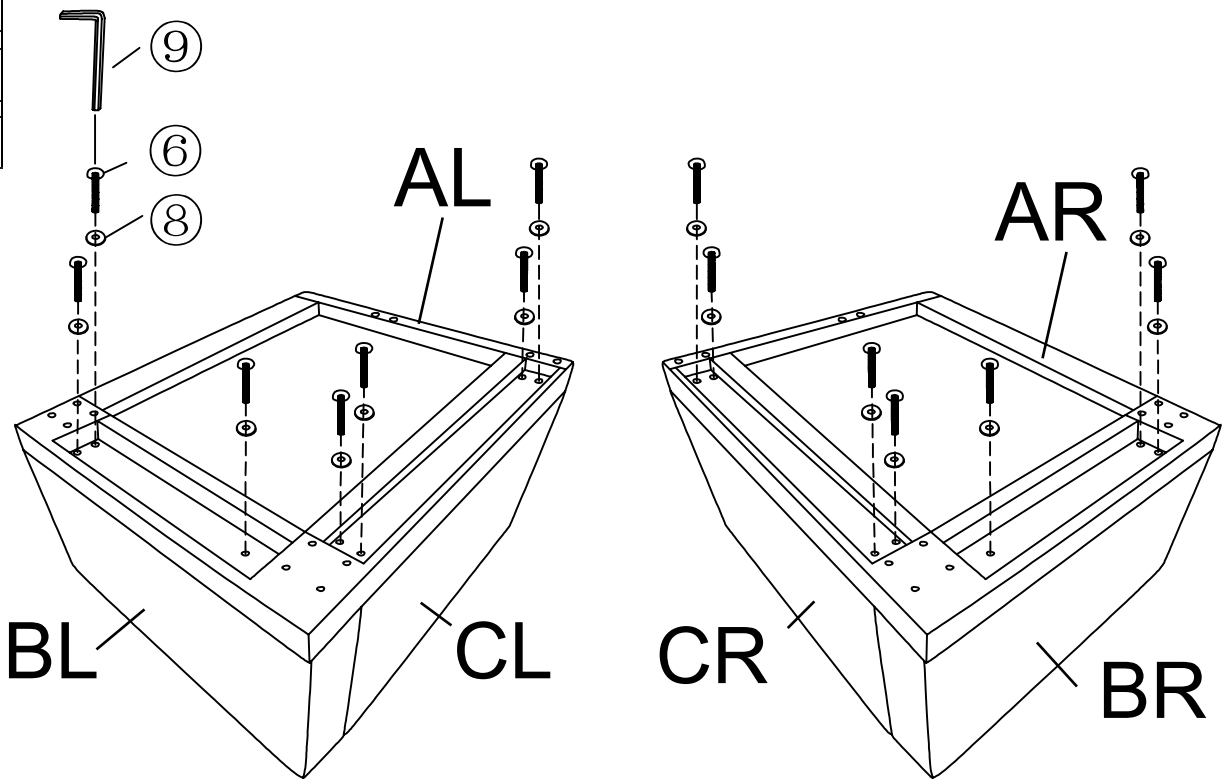

Step 5

⑩ x 1

⑦ x 2

⑧ x 2

⑨ x 1

⑤ x 24

④ x 6

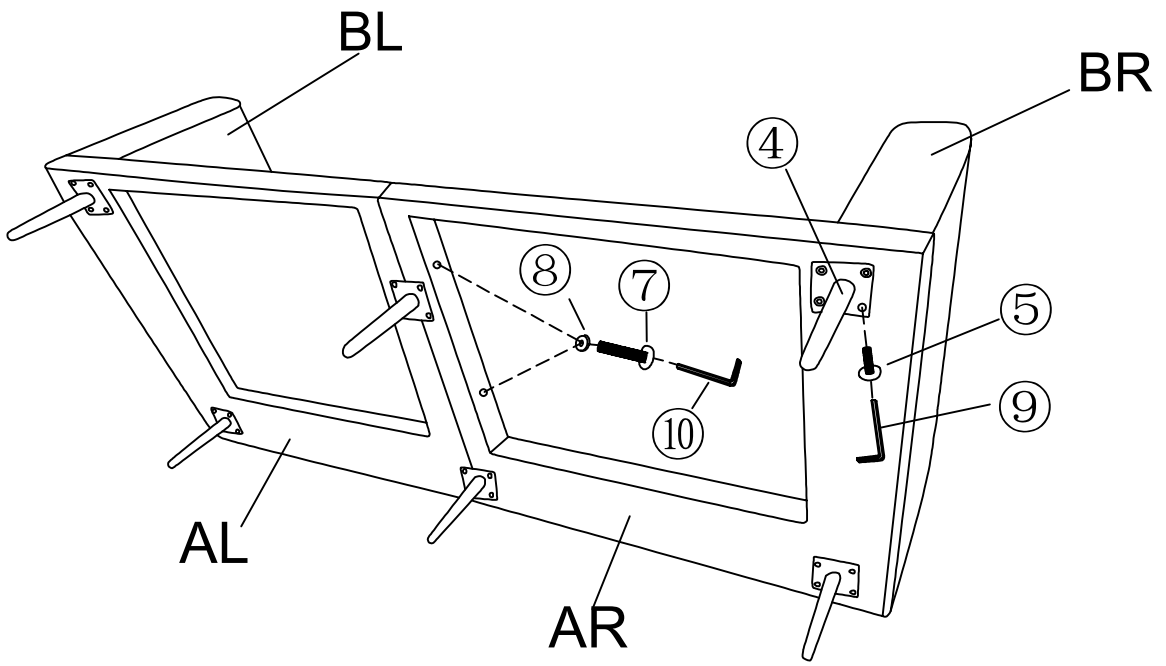

Step 6

⑨ x 1

⑤ x 8

③ x 2

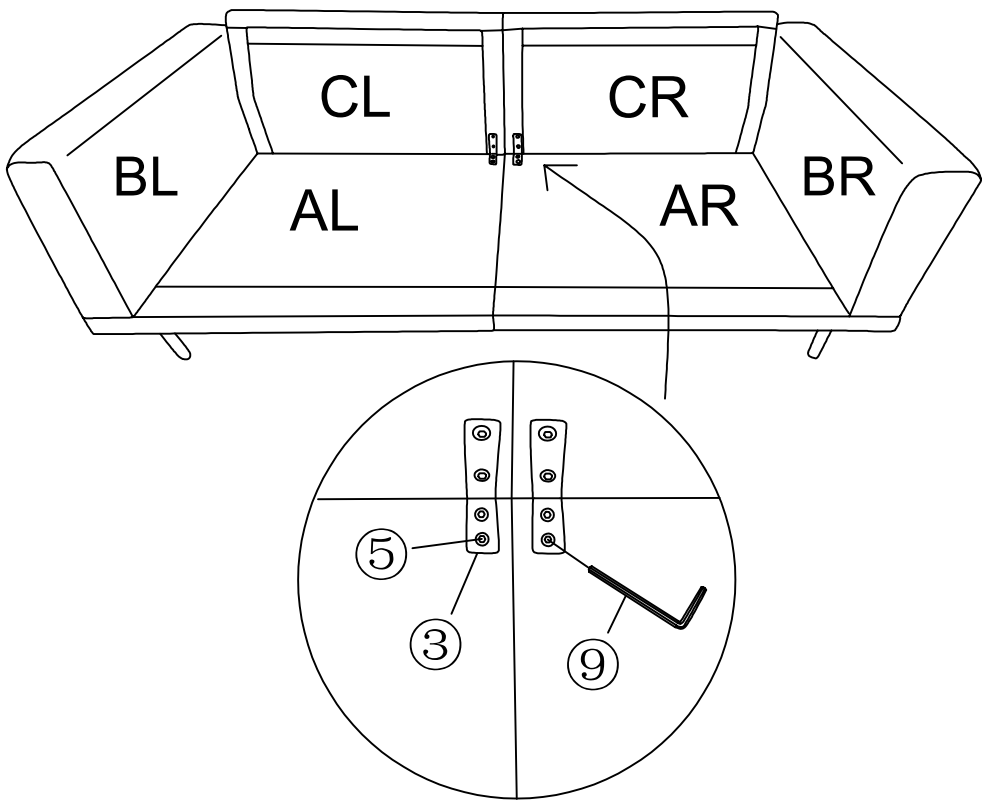

Step 7

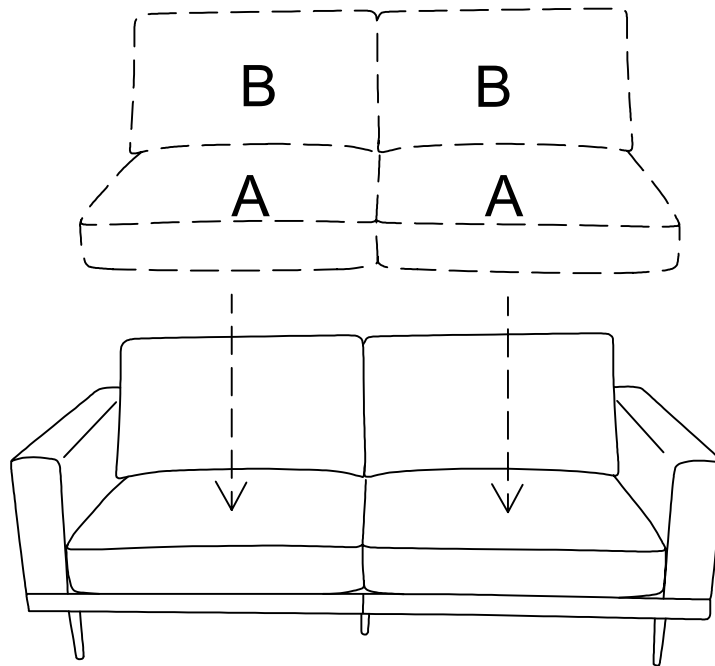

Step 8

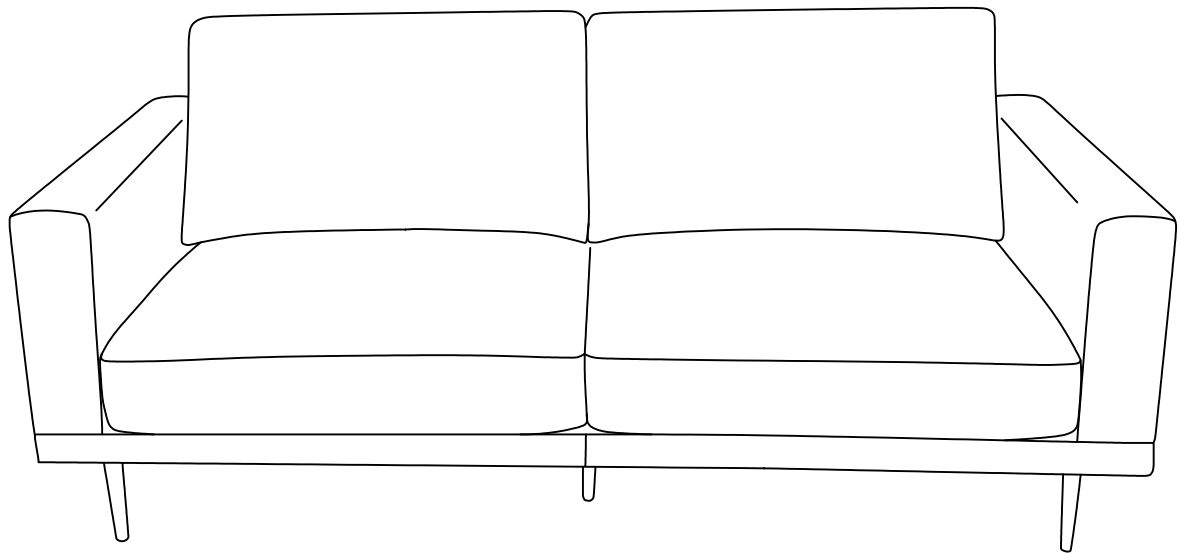

Your Chair is ready for use.
This Chair can only be used on a flat, level surface.