

100 Gallon Deck Box

Owner's Manual

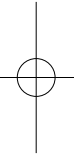

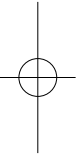
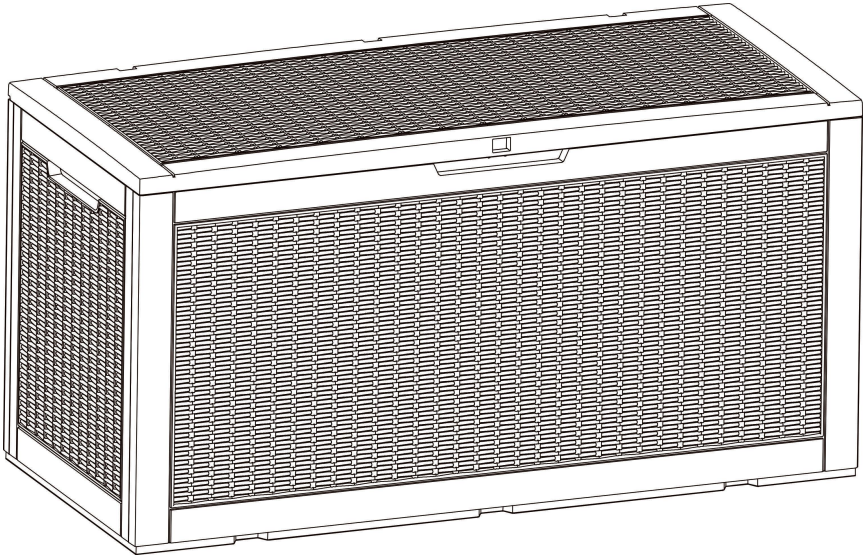

Deck Box Anatomy Diagram

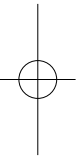
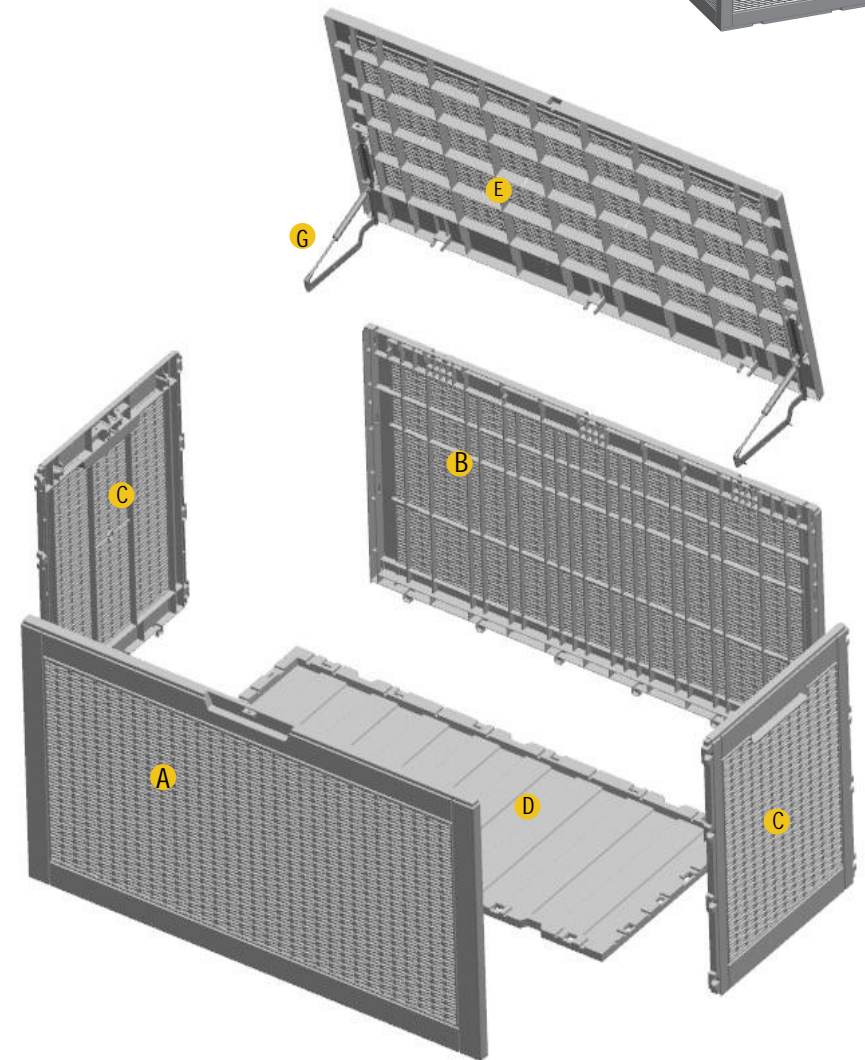

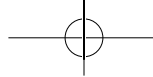

IMPORTANT CAUTION

Once installed, the product cannot be detached. Please strictly follow each step in the installation manual.

Please check all parts and components to ensure that there are no damages or missing items before starting the construction of the product. If you have any problems or discover any missing parts, please contact customer service at

Some parts may contain sharp edges. Wear protective gloves if necessary during assembly.

When using power tools, please adjust the gear to the minimum, otherwise it will cause damage to the parts.

ASSEMBLY INSTRUCTIONS

DO NOT assemble this item alone for your safety. Two people are necessary for smooth and safe installation.

Item identification: For ease of identification, all parts are labeled to correspond to the step number in which the part is used.

Force is required for installation.

The letter marks on the A/B/C/D/E panels should face inward when installing.

CARE & SAFETY

Check all panels for tightness before usage.

It is of utmost importance to assemble all parts according to the directions. Do not skip any step.

In case of fire, do not attempt to extinguish any burning polypropylene with water. Wear safety goggles and always follow the manufacturer's instructions when using power tools.

Using a stiff brush or abrasive cleaner could damage the box.

Hot items such as recently used grills, blowtorches, etc., must not be stored in the box.

After rain, wipe the box with cloth before opening.

Unsuitable for the storage of flammable or corrosive substances.

Do not stand on the lid.

To prevent the risk of suffocation, do not allow children to play inside the box.

PARTS LIST

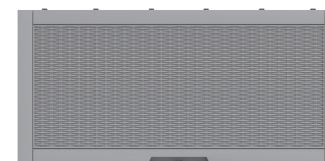

Front Panel

A (X1)

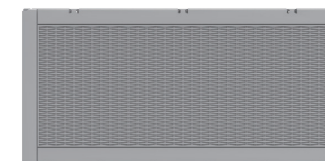

Back Panel

B (X1)

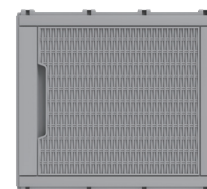

Side Panel

C (X2)



Bottom Panel

D (X1)

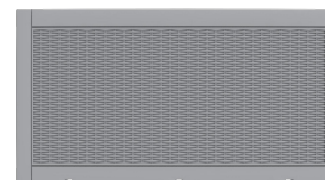

Lid Panel

E (X1)



Screw

F (X8) + Spare(X2)



Hydraulic Rod

G (X2)

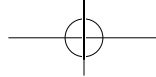

1 ASSEMBLY INSTRUCTIONS

Please match the marked sides as shown below.
Assemble two C panels to B panel.

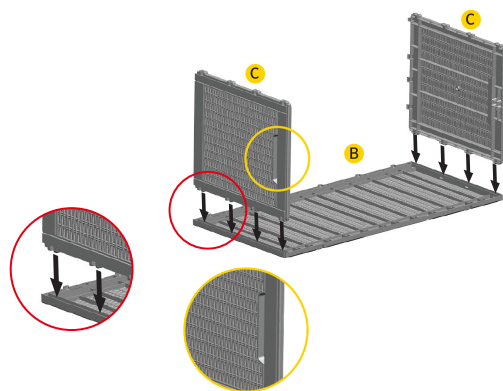
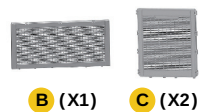

3 Take the bottom panel D and snap it.
The letter marks on the A/B/C/D/E panels should face inward when installing.

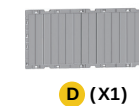

Before assembling the inserts, verify that the holes and inserts are aligned properly.

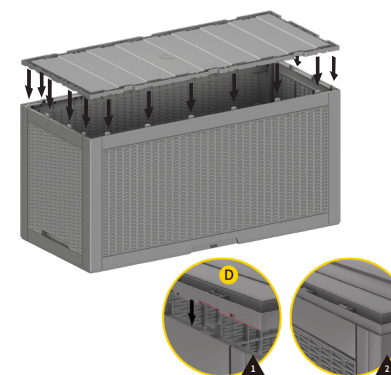

2 Attach panel A to the three-panel piece.

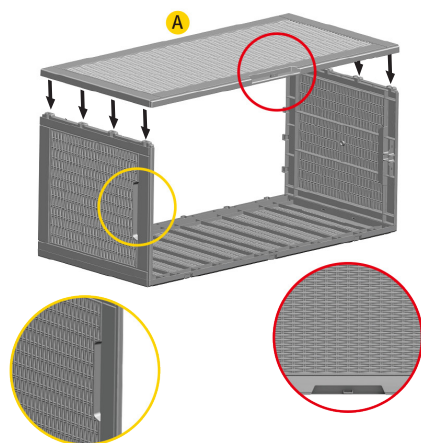
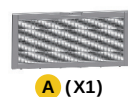

4 Lift the unit, align the fixtures, and slide the top panel E underneath it.
Installed with enough force or by using a rubber hammer.

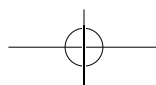
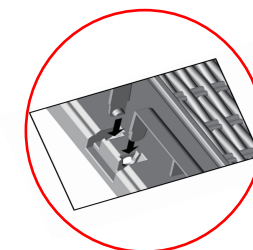
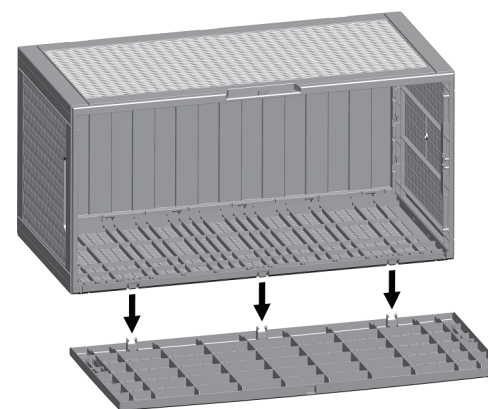

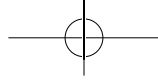

5

Insert the middle corner of the rod into the slit and secure it with 4 screws.

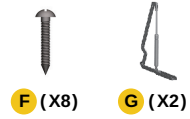

Open the hydraulic rod before assembling.

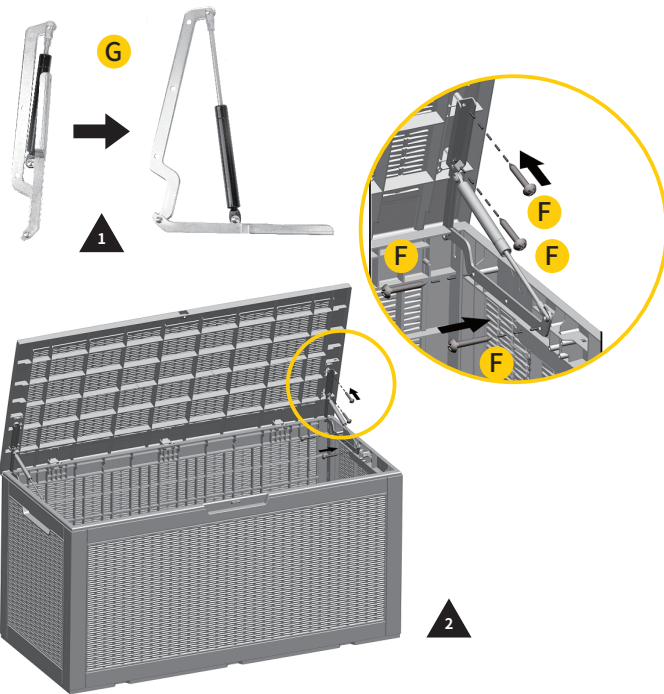

6

Finish by closing the top panel.

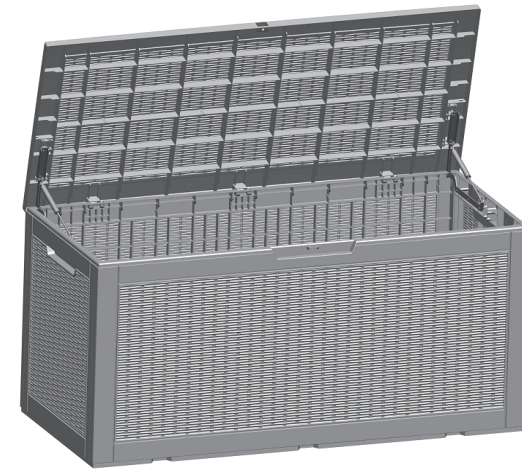

7

Installation completed.

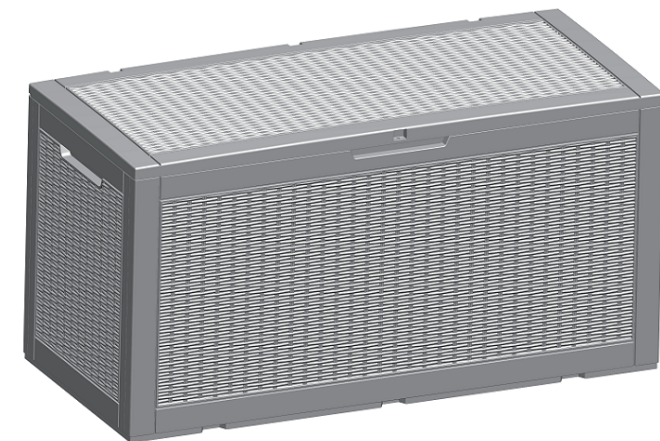

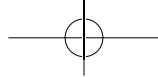

FEATURES

- Weatherproof and Waterproof Outdoor Furniture
- UV and Fade Resistance
- Durable and Long-lasting Use
- Easy to Assemble
- Marine-grade Quality Hardware
- Comfortable Side Handles
- Upgraded PP Material to Prevent Bending and Fading
- Use for Indoors and Outdoors, Pillows, Pool Toys, Garden Tools, Furniture and Sports Equipment
- Great Option for Home Storage and Organization

WHAT'S IN THE BOX

- 6 Deck Box Assemblies
- Hydraulic Rod
- Screw Package
- User Manual

Product use and maintenance recommendations

1. At regular check the deck box to ensure that it's stable and assembly integrity has been maintained.
2. This deck box should be far away from the open flame.
3. If use outdoor, please keep the deck box in a dry and flat place and covered with rainproof cloth on the roof
4. If the environment permits, install the deck box in a cool place, as prolonged exposure to direct sunlight may deform the panel and accelerate aging.
5. Do not store hot items (recently used grills, blowtorches etc.), flammable or caustic chemicals in the deck box.
6. Wash with a mild soap and water if there is any stain on the deck box. Do not use a stiff brush, bleach, ammonia or any other caustic cleaners, as these may damage the deck box or could result in permanent staining of the plastic.

This is not manufacturing defect and is not covered under warranty.

Return policy

1. For return and exchange orders:

(1) If the deck box you received is damaged or defective and need to be returned or replaced with new one, please kindly send us real images (product itself or packages). We will check and deal with it quickly.

(2) For product quality reason return and exchange orders: please take real images and contact us, we will provide prepaid return label for return or replace new product.

(3) For these reasons (bought by mistake, no longer needed, does not meet expectation, size smaller or bigger than expectation) return and exchange orders: customer need to cover the return shipping costs.

2. For cancel order: customer need to pay for shipping fee and carrier handle fee if the item has been shipped out.

3. For change address: customer need to pay for extra shipping fee and carrier handle fee if the item has been shipped out. Return policy

Return process:

1. Make a RETURN REQUEST on the Amazon.

2. Please ensure the integrity of the items and write the detailed information about return address, and then return the item.

3. Please inform us the tracking number of the returned package if you returned the item, this information is necessary for us. Otherwise, we don't know when you returned the item to the warehouse and can not refund in time.

4. Warehouse will check the return item within 3 business days after receiving it, and we will complete the refund within 2 days if the item is confirmed to have no problems.

Please note:

If returned defective, damaged or incorrect item and affects the re-sales, we will refund part of the money. The refund depends on the integrity of the package.

Warranty:

If there have product quality problem or the Installation Manual is not clear, please contact us, we will deal with it quickly

Due to defects resulting from normal wear and tear (scuffing, scratches caused during use, fading, abuse, unreasonable use, transporting or reassemble the product), natural disasters (storm, hail, flood and fire) and by animal types are not covered by the product warranty)

