

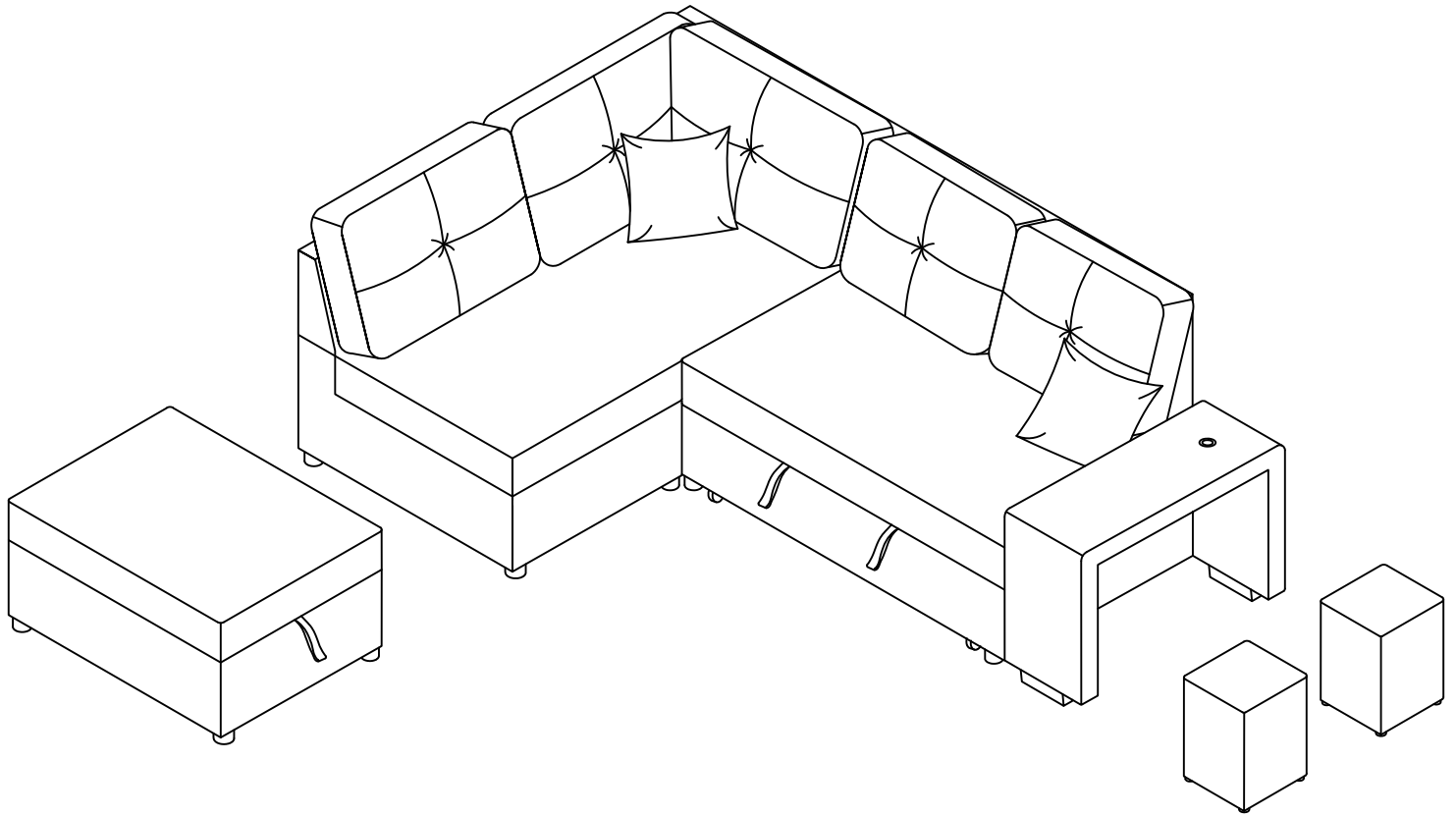

ASSEMBLY INSTRUCTION



ITEM NO.: WF314622 -WF314623-WF314624-WF314625







WF314623-COMPONENT LIST

| NO. | DRAWING | QTY | DESCRIPTION |
|-----|---|-----|---------------|
| D |  | 1 | Loveseat Body |
| F |  | 2 | Back Cushions |









WF314625-COMPONENT LIST

| NO. | DRAWING | QTY | DESCRIPTION |
|-----|---|-----|-------------|
| G |  | 1 | Ottoman |
| P |  | 2 | Pillows |
| B |  | 4 | Round legs |

WF314624-COMPONENT LIST



| | | | |
|---|---|---|----------------|
| D |  | 1 | Arm |
| H |  | 2 | Small ottomans |
| M |  | 2 | Square Legs |
| N |  | 4 | Bolts |
| O |  | 1 | Allen key |

WF314622-COMPONENT LIST

| NO. | DRAWING | QTY | DESCRIPTION |
|-----|---|-----|---------------------------|
| A |  | 1 | Loveseat Body |
| E |  | 1 | Loveseat Backrest |
| J |  | 1 | Loveseat Backrest |
| I |  | 1 | Corner Backrest |
| F |  | 1 | Back Cushion |
| K |  | 1 | Long Corner Back Cushion |
| L |  | 1 | Short Corner Back Cushion |
| B |  | 4 | Round legs |

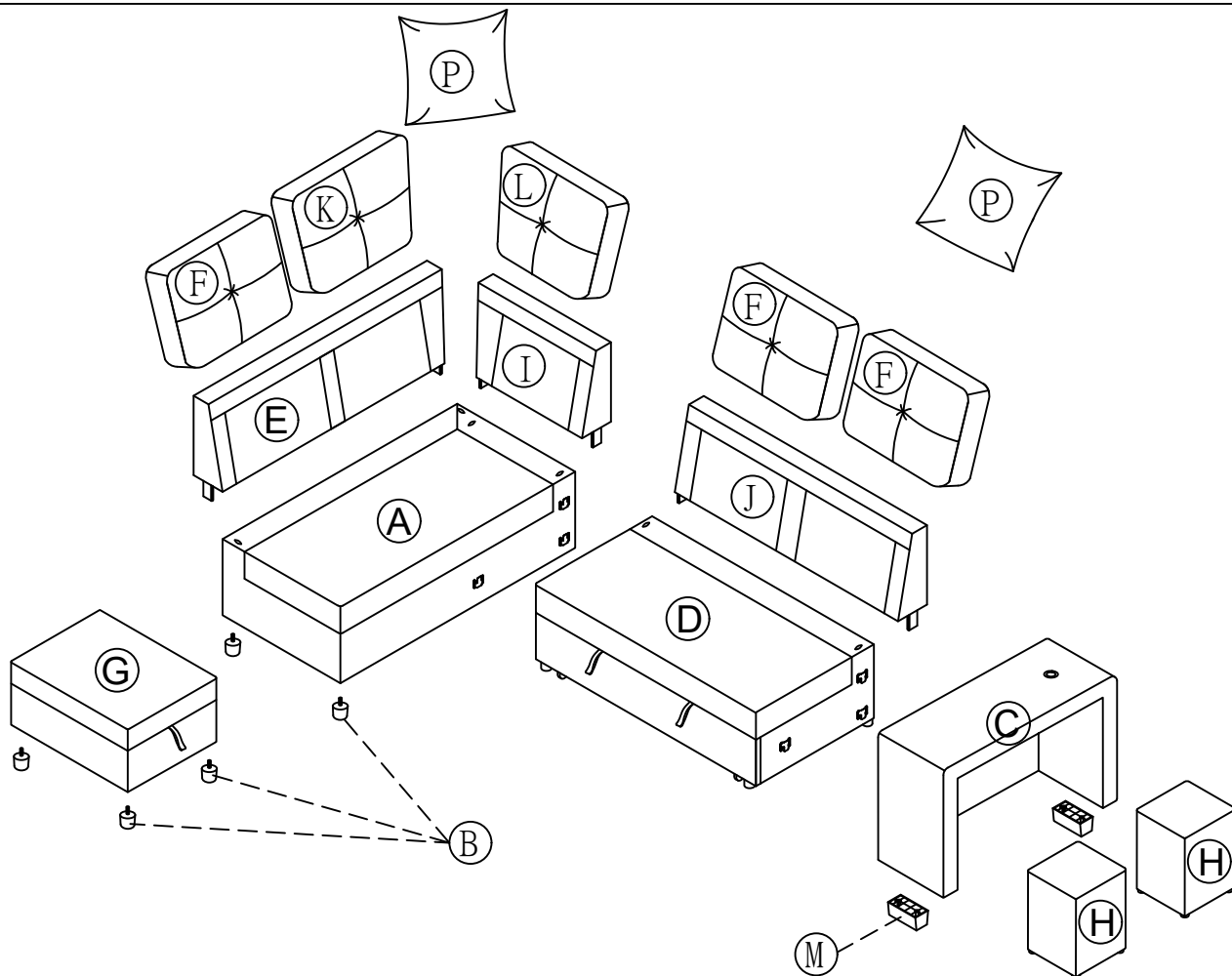
PARTS LIST

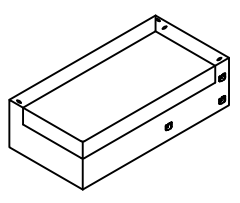
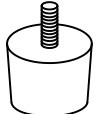
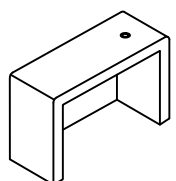
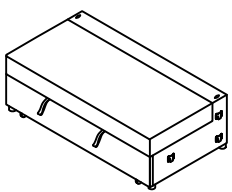
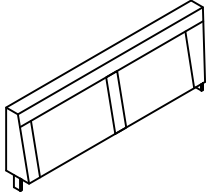
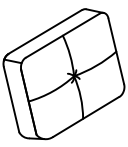
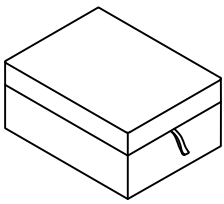
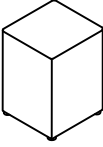
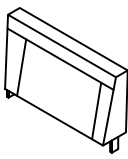
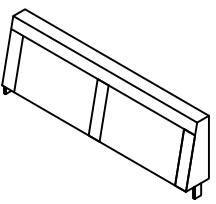
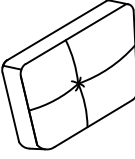
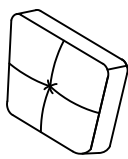
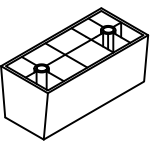

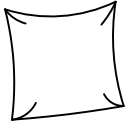
| | | | | | |
|--|---|---|--|---|---|
|  |  |  |  |  |  |
| <p>Loveseat Body X 1PC</p> | <p>Round legs X 8PCS</p> | <p>Arm X 1PC</p> | <p>Loveseat Body X 1PC</p> | <p>Loveseat Backrest X 1PC</p> | <p>Back Cushion X 3PCS</p> |
|  |  |  |  |  |  |
| <p>Ottoman X 1PC</p> | <p>Small ottoman X 2PCS</p> | <p>Corner Backrest X 1PC</p> | <p>Loveseat Backrest X 1PC</p> | <p>Long Corner Back Cushion X 1PC</p> | <p>Short Corner Back Cushion X 1PC</p> |
|  |  |  |  | | |
| <p>Square Legs X 2PCS</p> | <p>Bolt Ø5/16"x40MM X 4 PCS</p> | <p>Allen key X 1PC</p> | <p>Pillows X 2PCS</p> | | <p>Page 3 of 5</p> |

STEP 1:

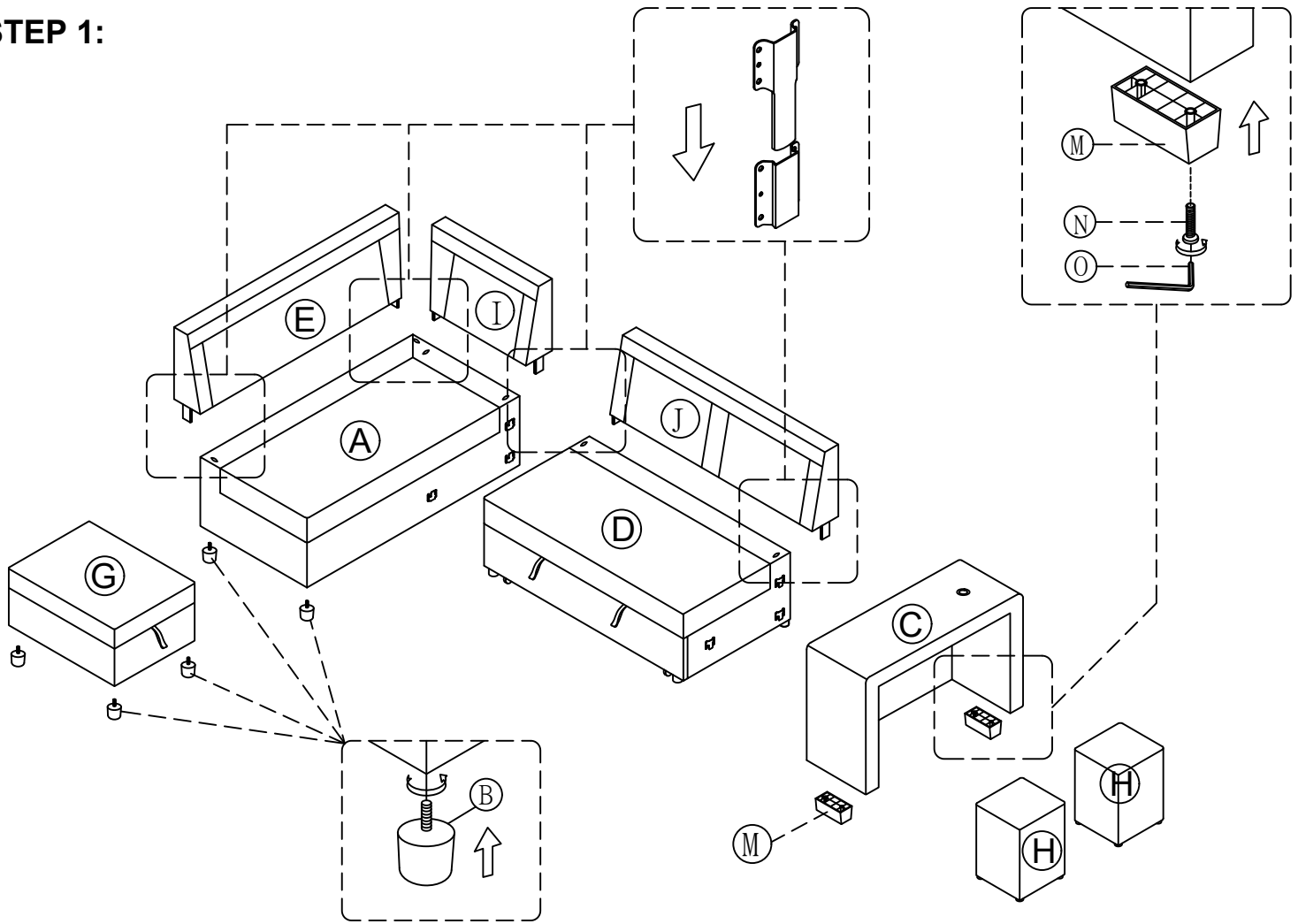

STEP 2:

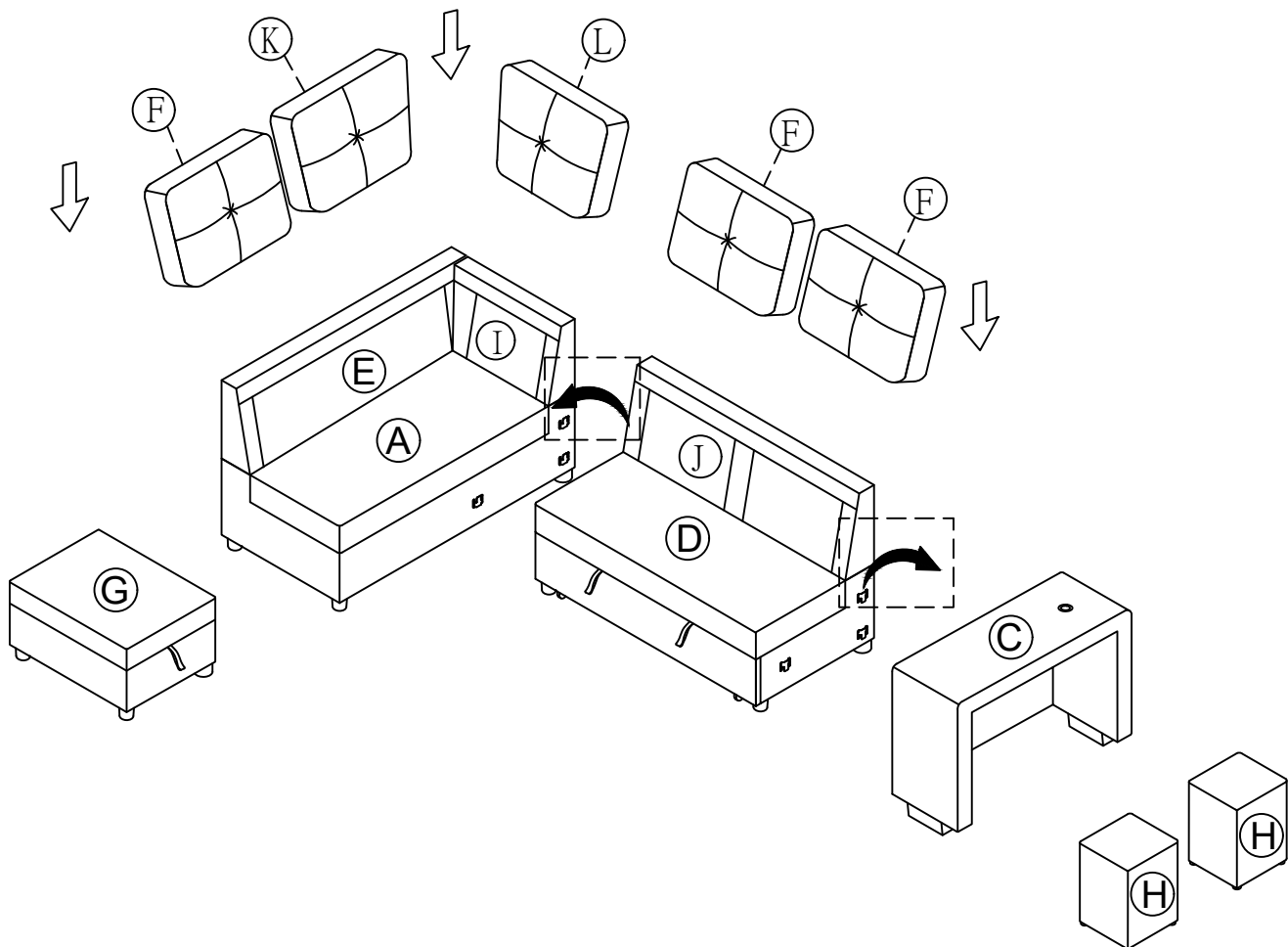

Helpful Hints

- Sofa bed can transform into a sleeper
- Move your new furniture carefully, with two people lifting and carrying the unit to its new location.
- Your furniture can be disassembled and reassembled to move.
- Clean the product with a soft damp cloth. **DO NOT** use harsh chemicals or abrasive cleaners.

COMPLETED

