

# **ASSEMBLY INSTRUCTION**

---

**WF300691**

**WF300692**

**WF300693**

Friendly Reminder:

- 1.This sofa is packed in 3 boxes. Please assemble it After all boxes are received.
- 2.As the cushions are all vacuum compressed,there will be some wrinkles.  
Please give your cushions up to 72 hours to reach its original size and the wrinkles will basically disappear.
- 3.Please do not open the compressed packags until your sofa frame is completely assembled.

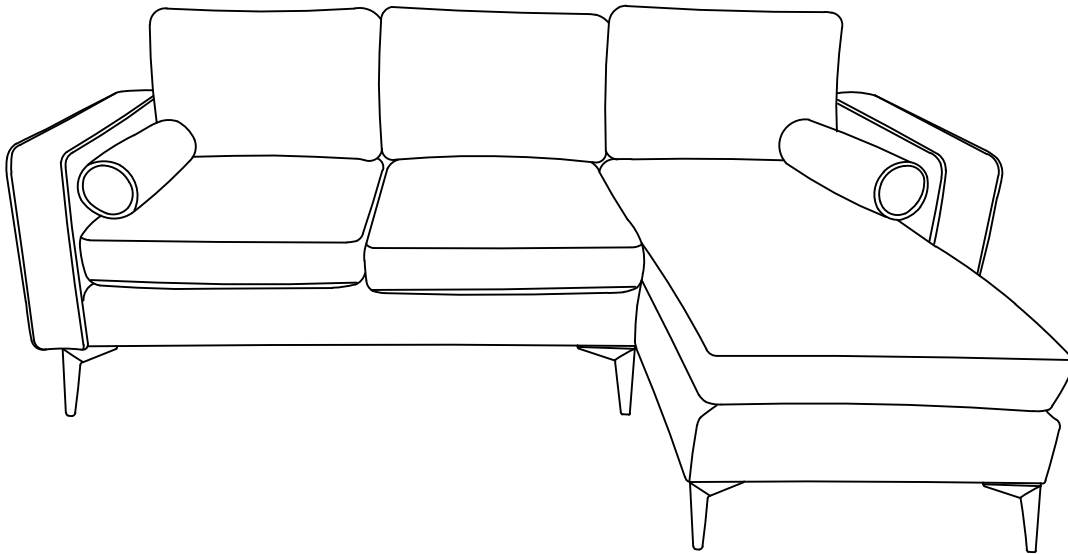





Return & Warranty policy:

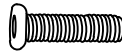

- We strive to offer the highest quality products,and we also try our best to satisfy each and every customer that orders from us with replacement parts or service as needed.
- If the item is damaged or defective, please take photos as evidence for replacements and refunds.
- Please do not return to store,contact the seller if you have any troubles with this product.

# ASSEMBLY INSTRUCTION

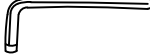
## HARDWARE

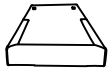
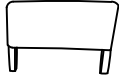
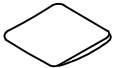

NO	DESCRIPTION	SKETCH	QTY
1	Washer		20
2	Screws 8X18		18
3	Screws 8X60		16
4	Screws 8X80		2
5	Butterfly Nut		2
6	Wrench		1

## PARTS LIST WF300691



NO	DESCRIPTION	SKETCH	QTY
B	Chaise Frame		1
C	Chaise Backrest		1
H	Love Seat Cushion		2
J	Chaise Cushion		1
K	Chaise Cushion Cover		1

# **ASSEMBLY INSTRUCTION**

## **PARTS LIST WF300691**

NO	DESCRIPTION	SKETCH	QTY
L	Back Cushion		1
M	Throw pillows		2
N	Leg		9

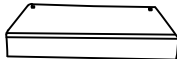
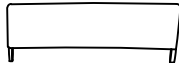
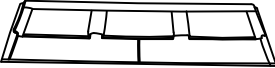
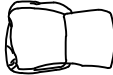
## **PARTS LIST WF300692**

NO	DESCRIPTION	SKETCH	QTY
A	Love Seat Frame		1
D	Love Seat Backrest		1
E	Back cover		1
I	Love Seat Cover		2
L	Back Cushion		2

## **PARTS LIST WF300693**

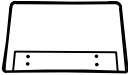
NO	DESCRIPTION	SKETCH	QTY
F	Armrest (Left)		1
G	Armrest (Right)		1

## DIAGRAM 1

Tack the Love Seat Backrest(Parts D)Back cover(Parts E)Love Seat Cover (Parts I)Back Cushion(Parts L)out of the Love Seat Frame(Parts A).

Tack the Chaise Backrest(Parts C)Chaise Cushion Cover (Parts K)Back Cushion (Parts L)Throw pillows (Parts M)Leg(Parts N)out of the Chaise Frame(Parts B).

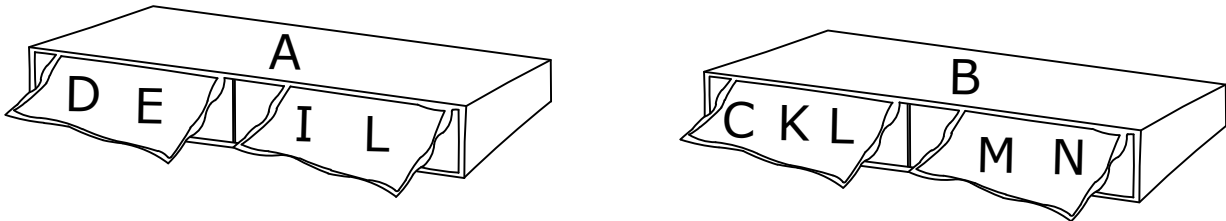

## DIAGRAM 2



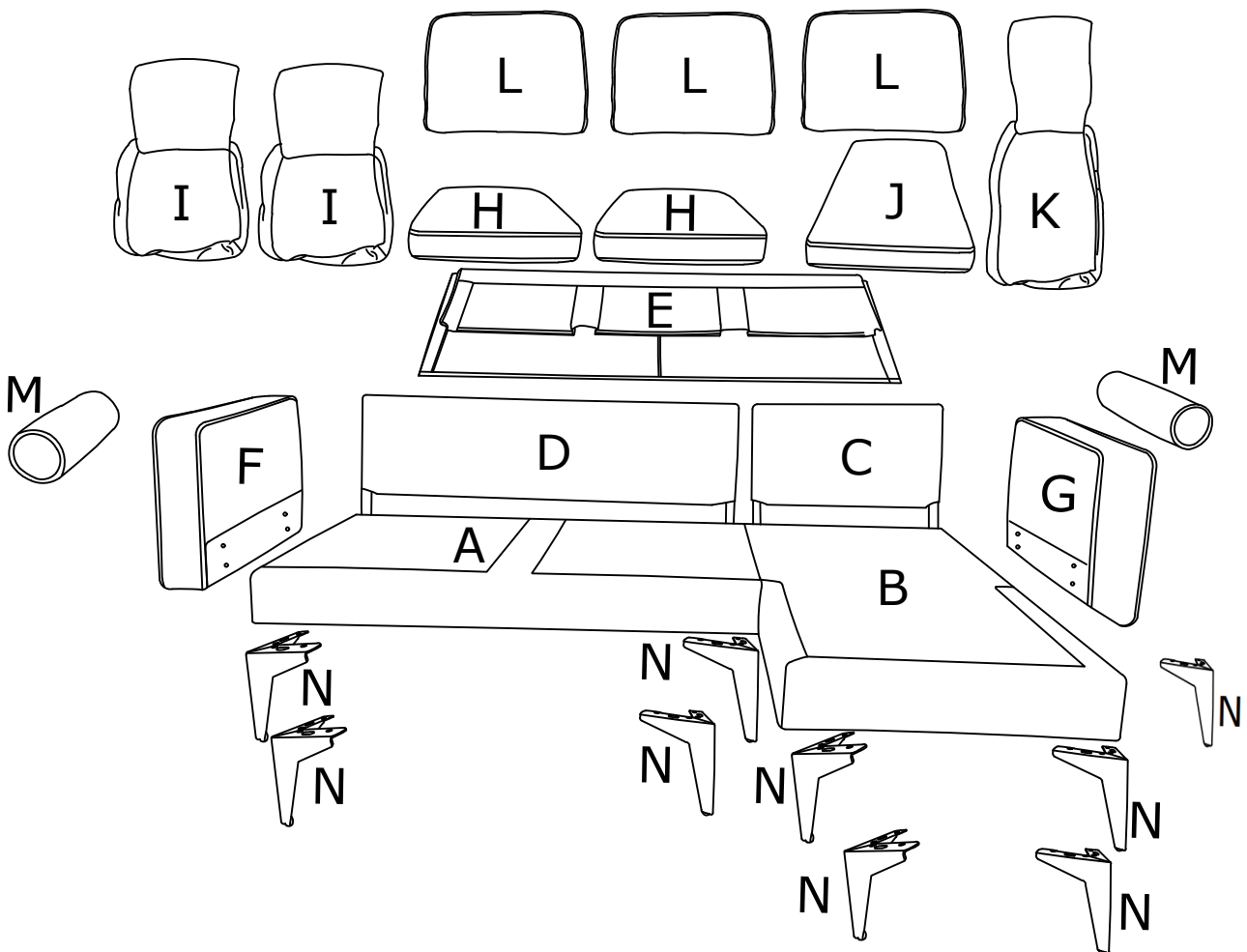

All parts and hardwares.

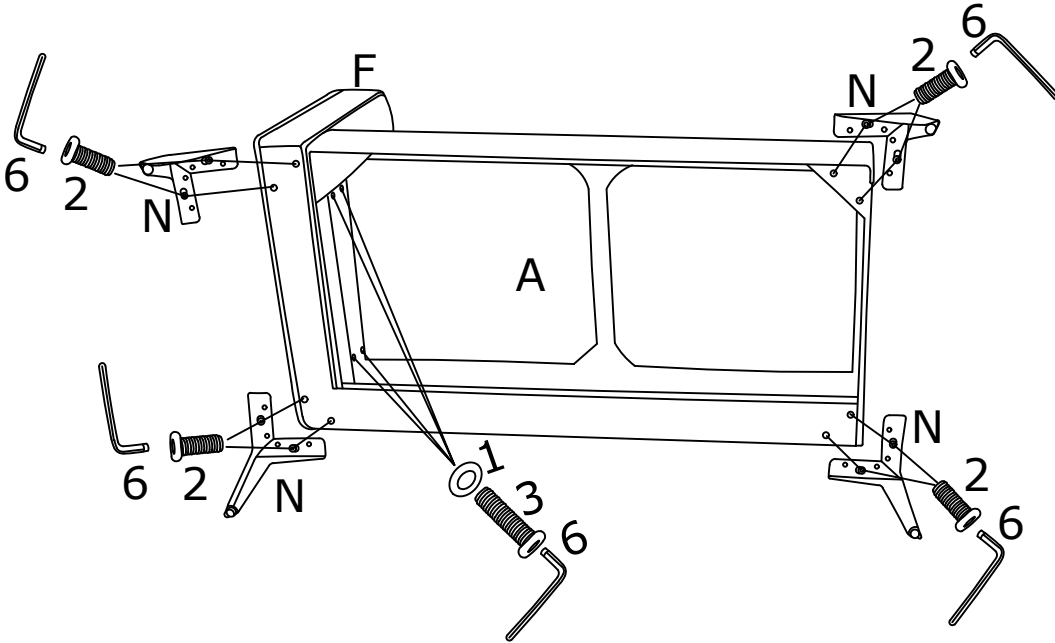

### DIAGRAM 3

Connect the armrest (Parts F) with the Love Seat Frame (Parts A) tighten the washer (Hardware 1) screws (Hardware 3) by wrench (Hardware 6). Tighten 4 legs (Parts N) by screws (Hardware 2) using the wrench (Hardware 6).







1		4PCS
2	 M8X18	8PCS
3	 M8X60	4PCS
N		4PCS

### DIAGRAM 4

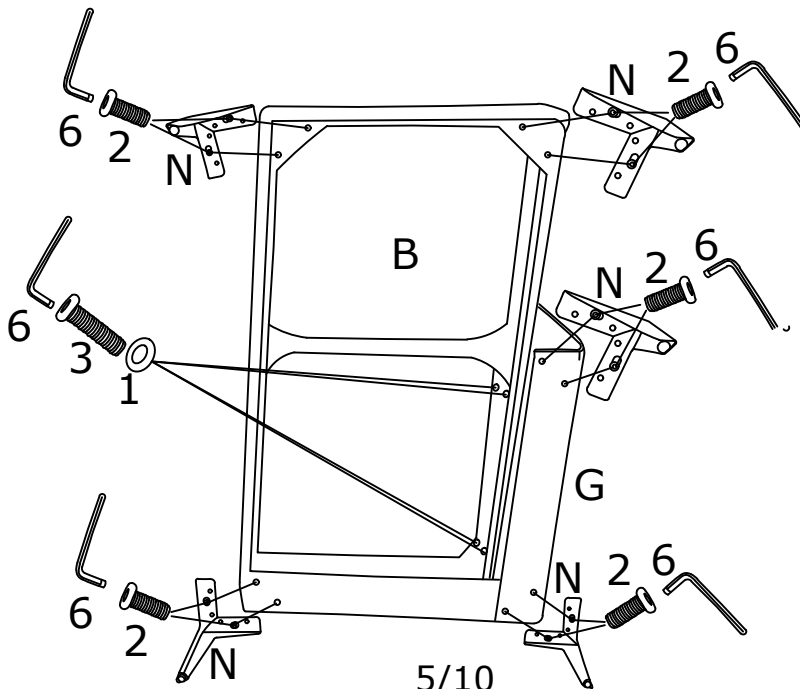
Connect the armrest (Parts F) with the Chaise Frame (Parts B) tighten the washer (Hardware 1) screws (Hardware 3) by wrench (Hardware 6).



Tighten 4 legs (Parts N) by screws (Hardware 2) using the wrench (Hardware 6).



1		4PCS
2	 M8X18	10PCS
3	 M8X60	4PCS
N		5PCS

### DIAGRAM 5

Connect the love seat sofa with the chaise sofa tighten the screws(Hardware 4)with the butterfly nuts(Hardware 5)and washer(Hardware 1)by wrench(Hardware 6).

1		4PCS
4	 M8X80	2PCS
5		2PCS

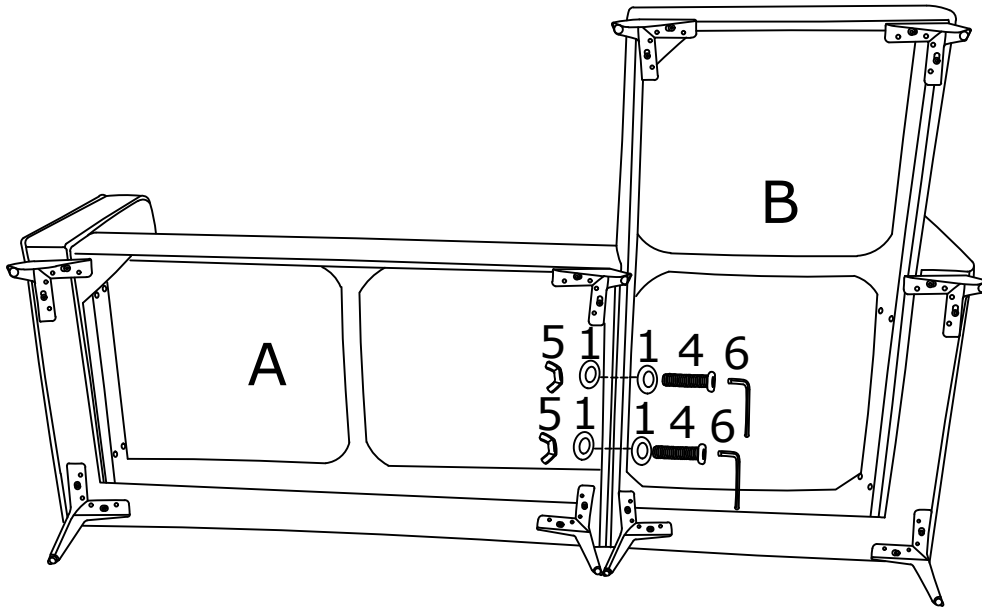

### DIAGRAM 6

Connect the Love Seat Backrest (Hardware D) with the Chaise Backrest (PartsC).

tighten the 4 Screws(Hardware 3)with the(Hardware 1) by wrench(Hardware 6)

Please install the top screws first, and then install the next screws.

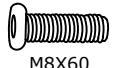

Don't tighten any screws before you ensure all the screws are put in the holes.

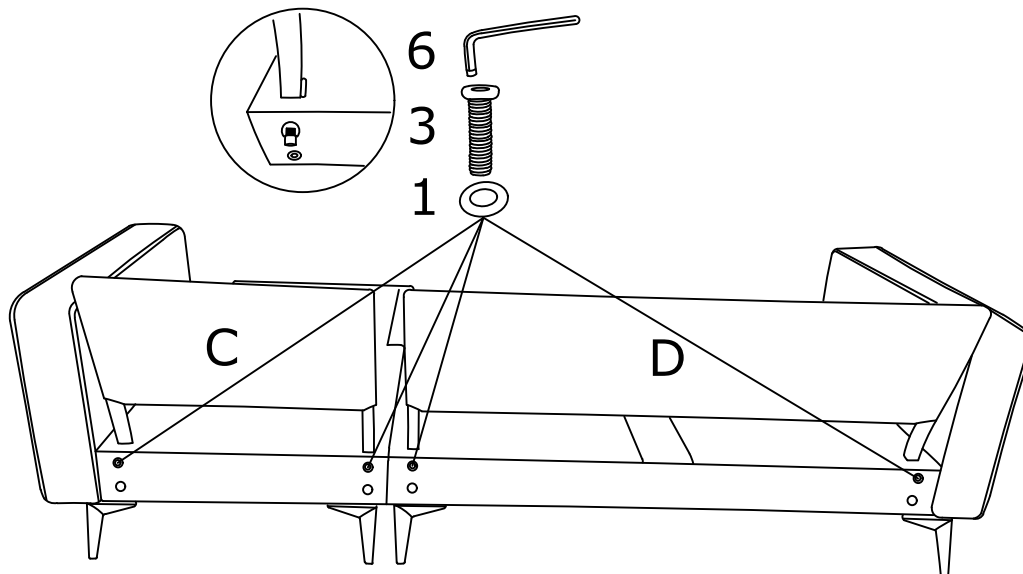
1		4PCS
3	 M8X60	4PCS



### DIAGRAM 7

Connect the Love Seat Backrest (Parts D) with Chaise Backrest (Parts C)  
tighten the 4 Screws(Hardware 3)with the (Hardware 1) by wrench(Hardware 6)

1		4PCS
3	 M8X60	4PCS

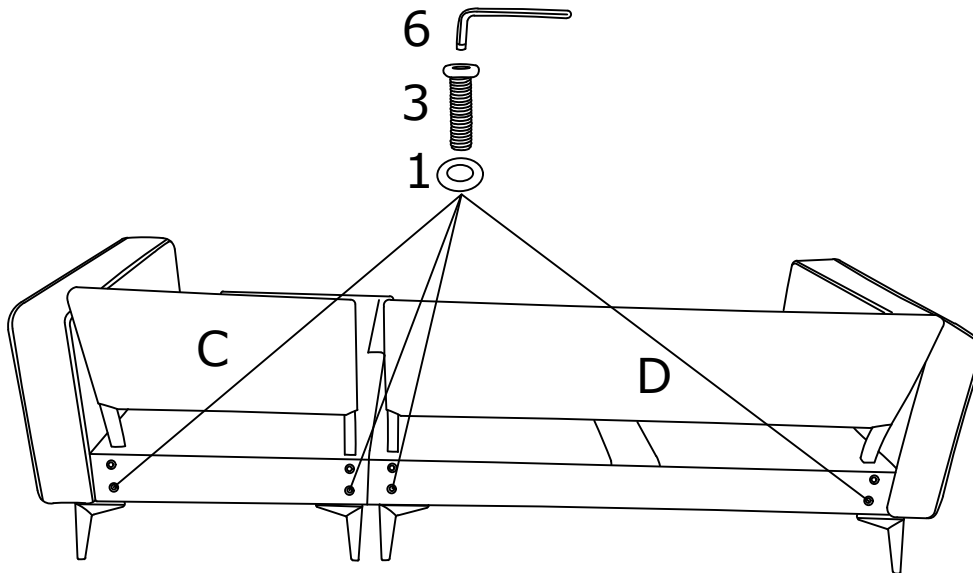

### DIAGRAM 8

Place the back cover (Parts E) over the backrest (Parts C and Parts D) .

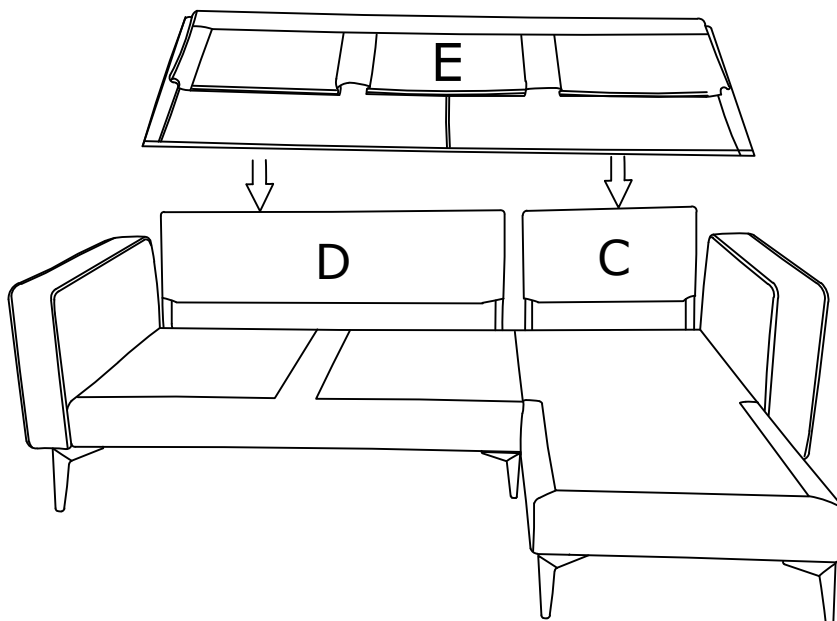

### DIAGRAM 9

Remove the plastic bags of Love Seat Cushion(Parts H) and Chaise Cushion (Parts J).  
Please align the chain first and then pinch the zipper gently and close it smoothly.

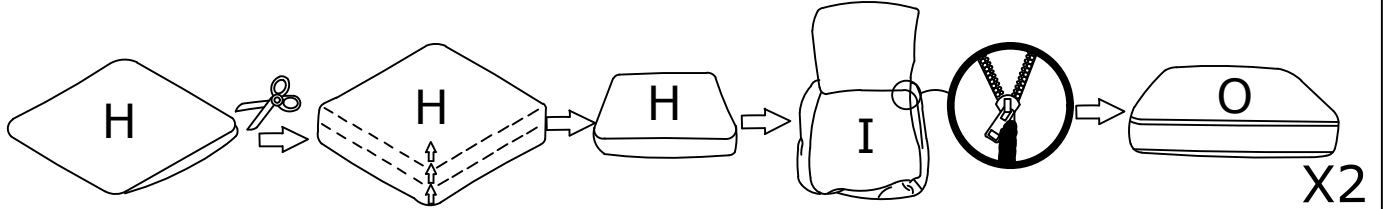

Stuffing Love Seat Cushion(Parts H) into Love Seat Cover(Parts I) and zip it up.

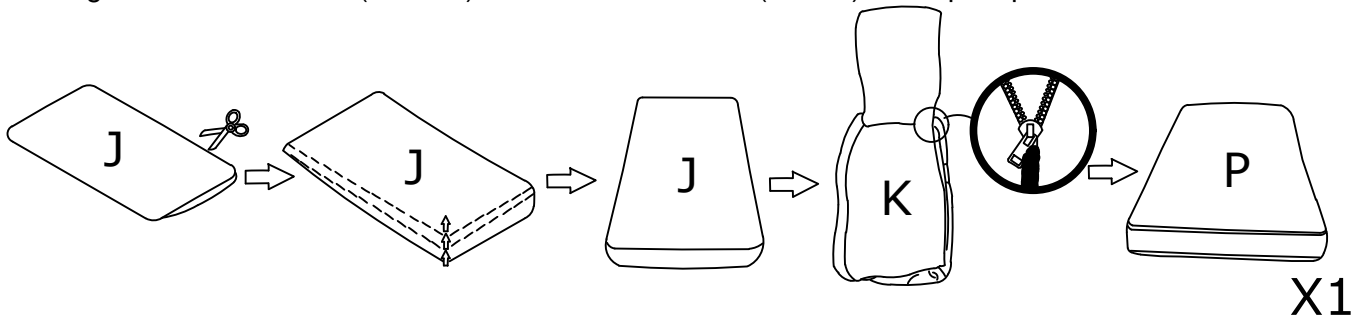

Stuffing Chaise Cushion(Parts J) into Chaise Cushion Cover (Parts K) and zip it up.

### DIAGRAM 10

Remove the plastic bags of Back Cushion(Parts L) and Throw pillows(Parts M).

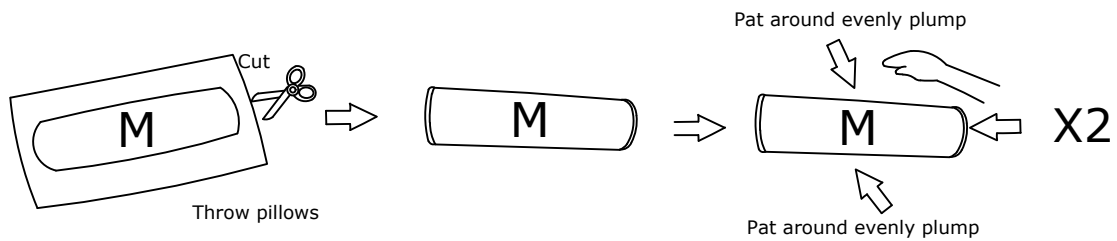
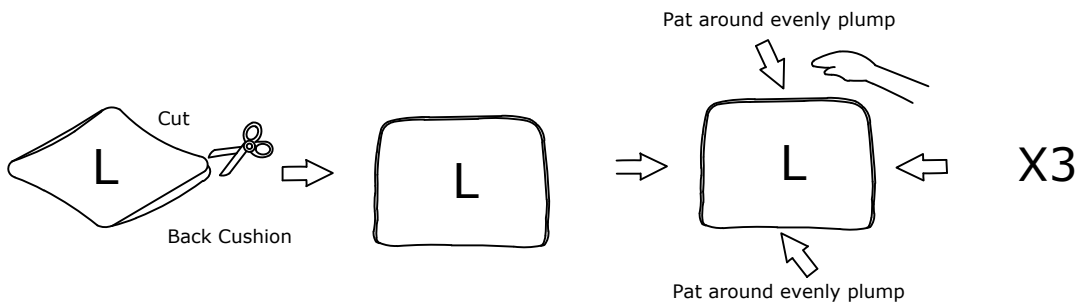

**TIPS :**

1. Please do not open the compressed packages until your sofa frame is completely assembled.
2. Compressed back cushions and pillows need to be fully fulfilled within 72 hours for your perfect use.
3. Please keep children away from plastic bags or any small pieces of stuff.

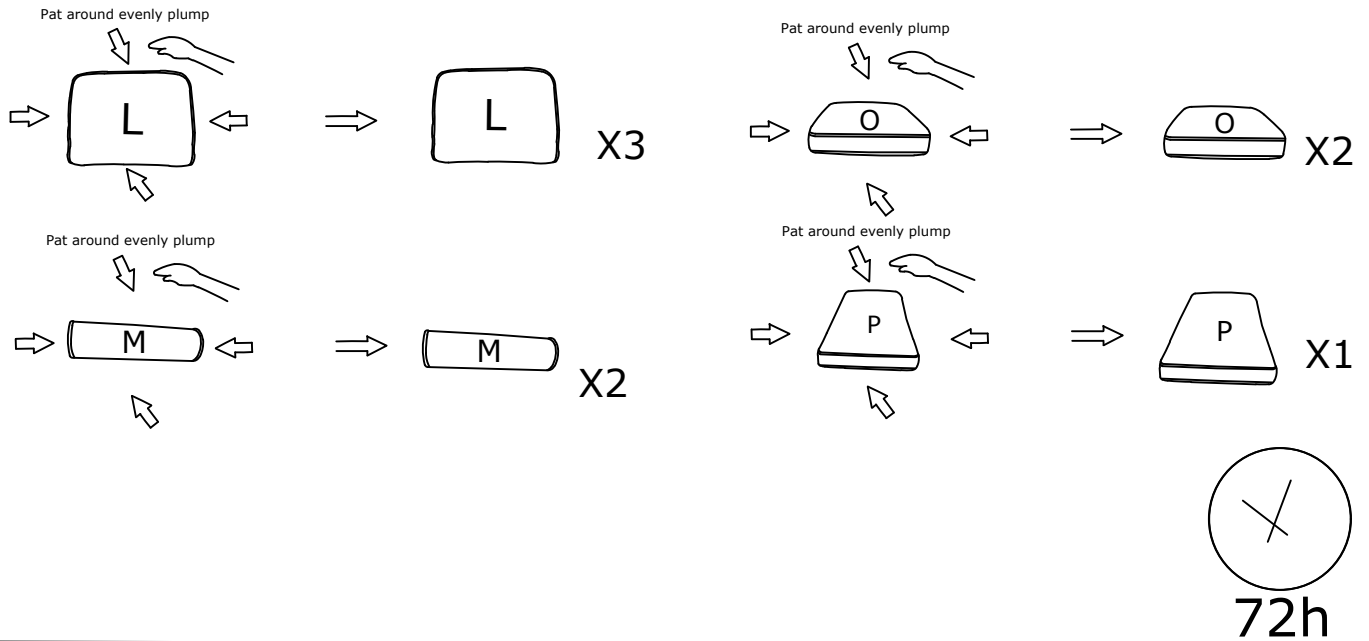

**DIAGRAM 12**

Put the Love Seat Cushion (Parts O) the Chaise Cushion (Parts P ) the Throw pillows (Parts M ) on the sofa.  
Recheck all the bolts before you sit on the sofa.

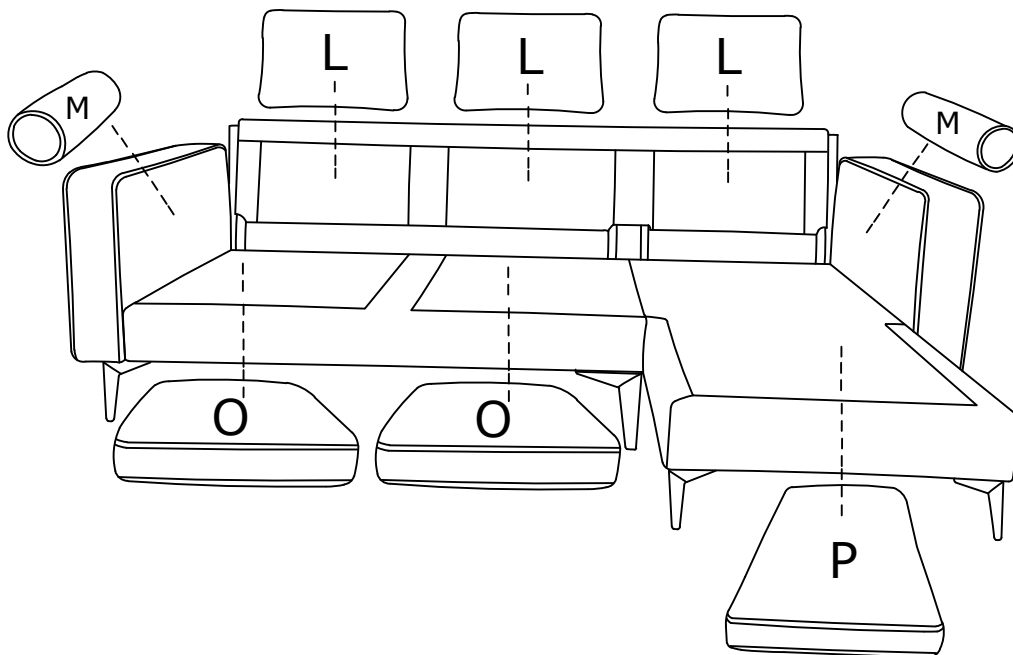

**TIPS :**

1. Please do not open the compressed packages until your sofa frame is completely assembled.
2. Compressed back cushions and pillows need to be fully fulfilled within 72 hours for your perfect use.
3. Please keep children away from plastic bags or any small pieces of stuff.

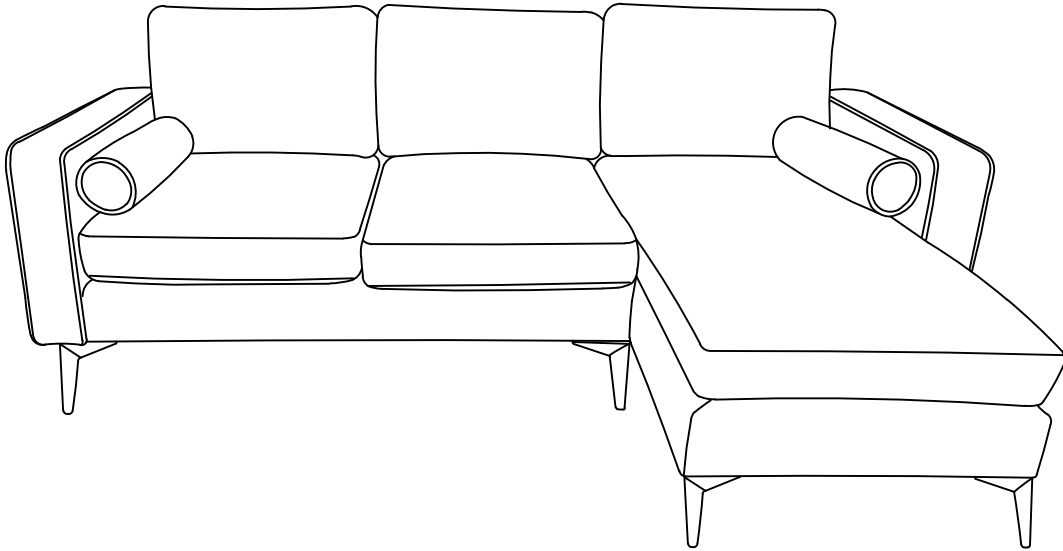

**or**

