

**ASSEMBLY INSTRUCTIONS**  
**HERITAGE PARSON CHAIR**

**ITEM NO.:1968-02-3A**  
**DEMENSION:W21.45" X D 25.6" X H 36.6"**

**PART LIST**

**(A)** Back assembly (1pc)

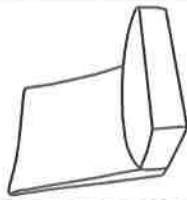

**(B)** Front legs-(2pcs) put inside the seat cushion

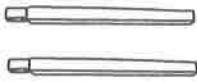

**(C)** Back legs-(2pcs) put inside the seat cushion

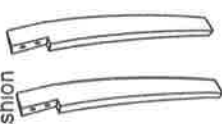

**DO NOT FULLY TIGHTEN SCREWS AND BOLTS UNTIL THE ENTIRE ITEM IS COMPLETELY ASSEMBLED**

**NOTICE**

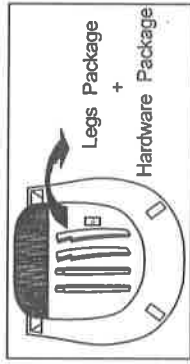

**STEP 1**

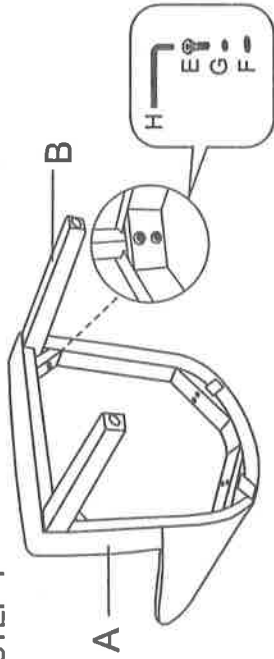

**Step1:**Put the screws in the holes,tighten the screws,but not too tighten,90% is ok.

**STEP 2**



**Step 2:**Put the screws in the holes,tighten the screws,but not too tighten,80% is ok.

**STEP 3**

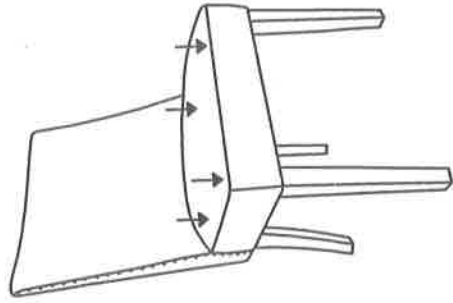

**Step 3:** Then adjust the balance of this chair,tighten all the screws to100%.

**STEP 4**

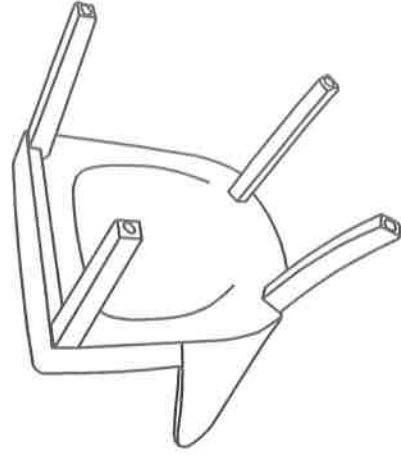

**Step4 :**Finally,zip up the non-woven cover underneath the seat.

**HARDWARE LIST**

Screw D		(1) M8X55MM (4PCS)	(4) 8pcs
Screw E		(2) M8X70MM (4PCS)	(2) 8pcs
Flat washer F		(3) 8pcs	(3) 8pcs
Spring washer G		(4) 8pcs	(4) 8pcs
Allen key H		M8 (5) 1PC	(5) 1PC