

Assembly Instructions

909113 - Ventura Antique White

909118 - Ventura Espresso

909119 - Ventura Grey

Product Issues? Please Call Us Before Contacting Your Retailer

At 1-800-549-3300 or www.mshome.co

**We can help with Assembly Issues, Part Requests,
Damages, & All Other Product Related Questions**

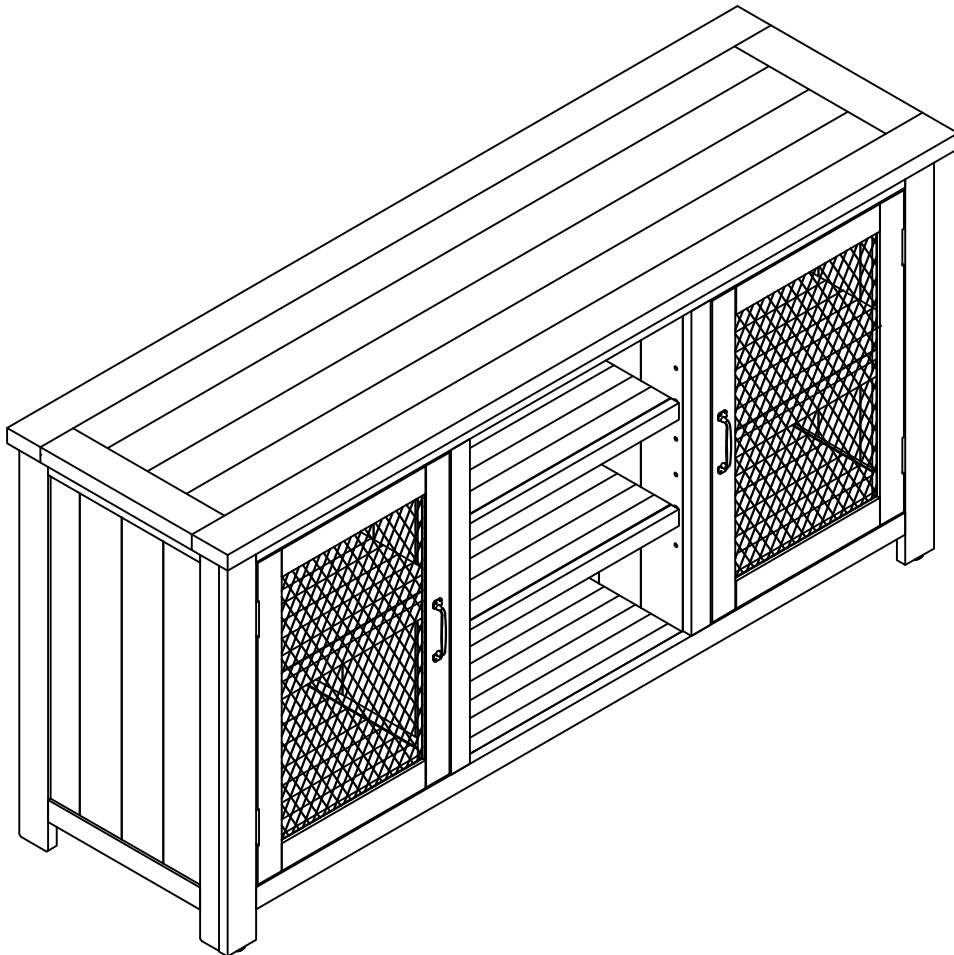

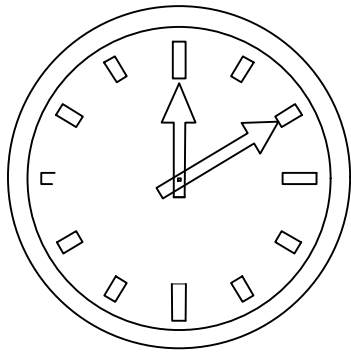



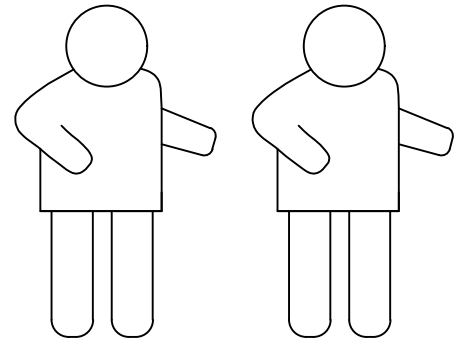

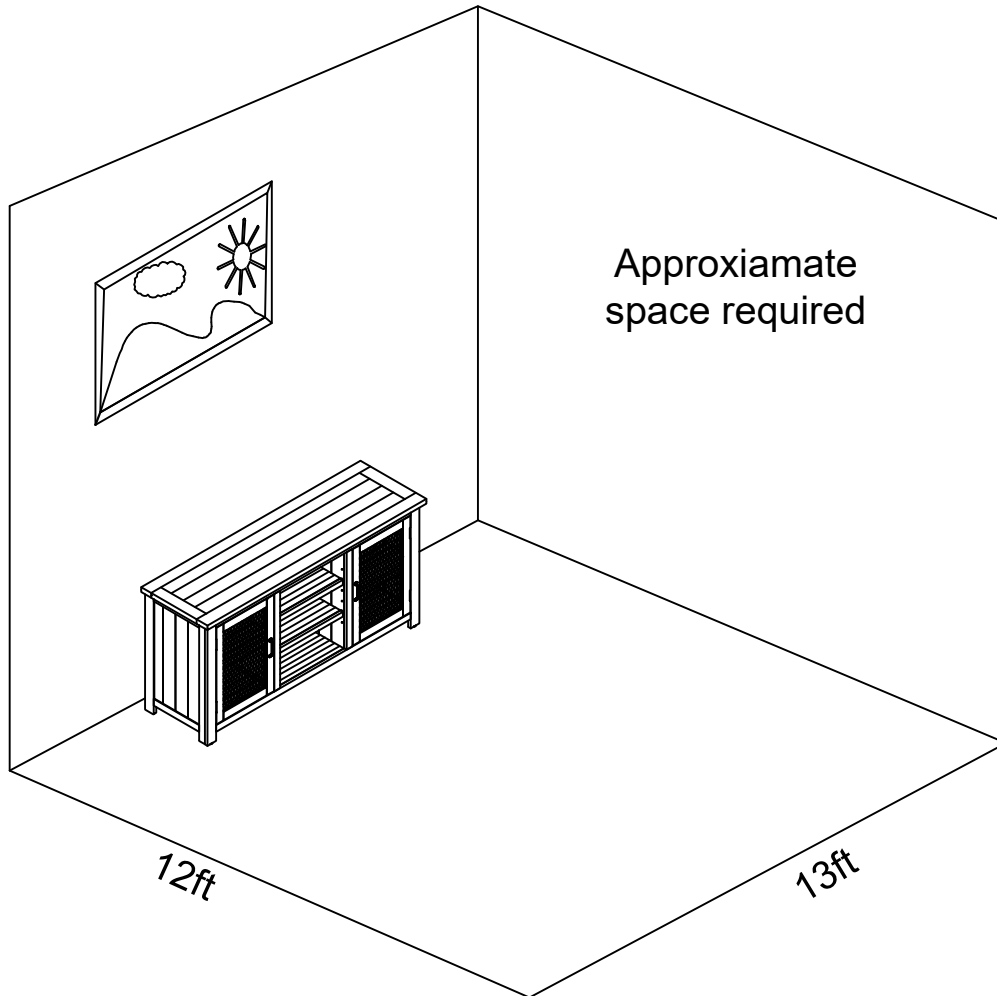

10 min

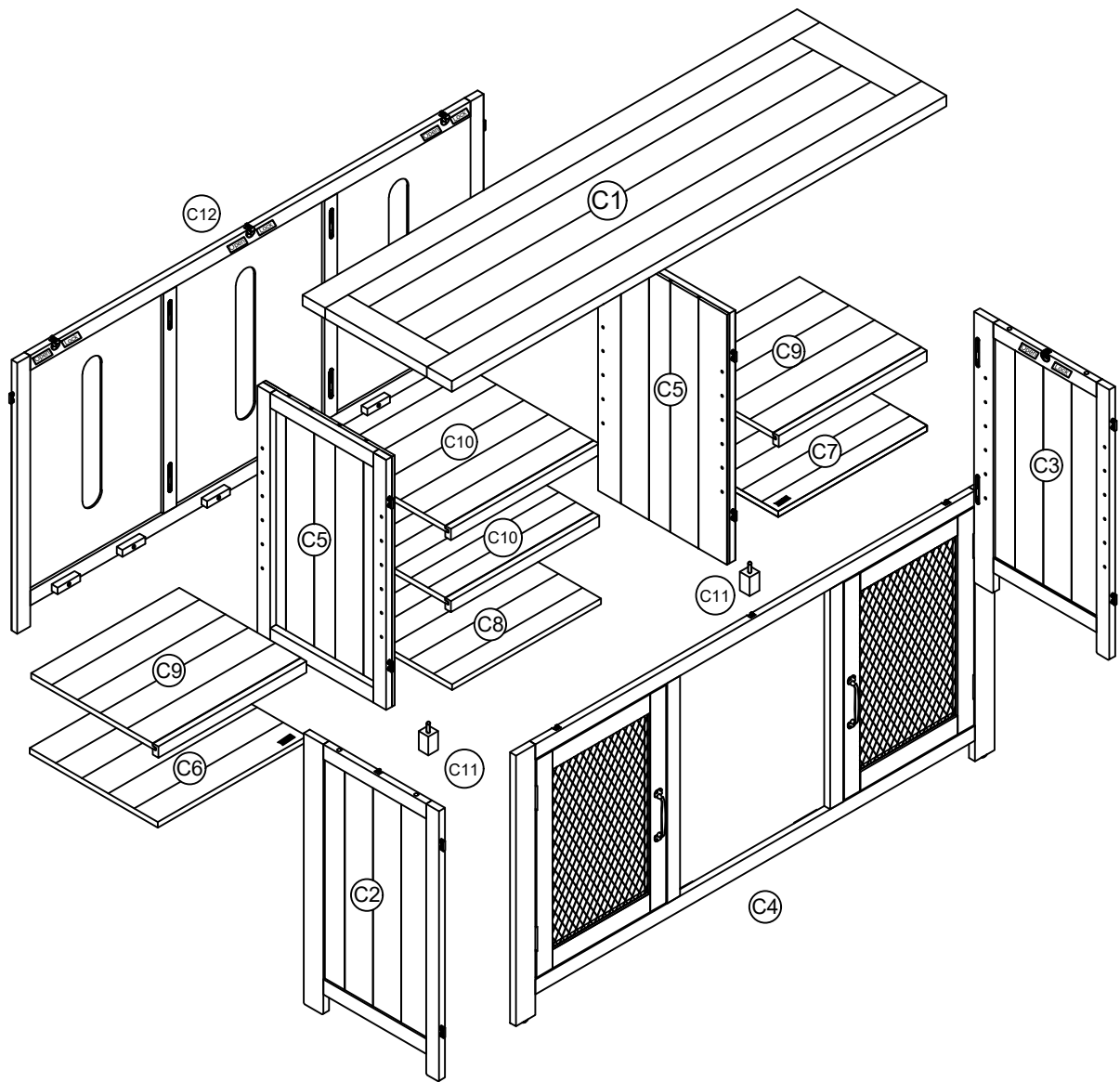

Two People Required



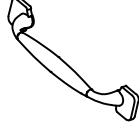

| | | | | |
|---|---|--|--|---|
| <p>A</p>  <p>Ø8x30 (mm) 4pcs</p> | <p>B</p>  <p>16pcs</p> | <p>C</p>  <p>Ø3.5x10 (mm) 16pcs</p> | <p>D</p>  <p>2 PCS</p> | <p>E</p>  <p>Ø4x25 (mm) 4pcs</p> |
|---|---|--|--|---|

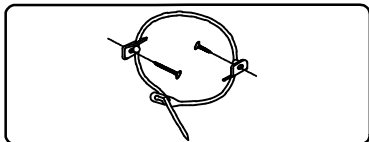

ANTI-TIP SET

1

Please lay all components on smooth flat surface to prevent scratches
Use the EPE foam to protect the plastic hardware before assembly

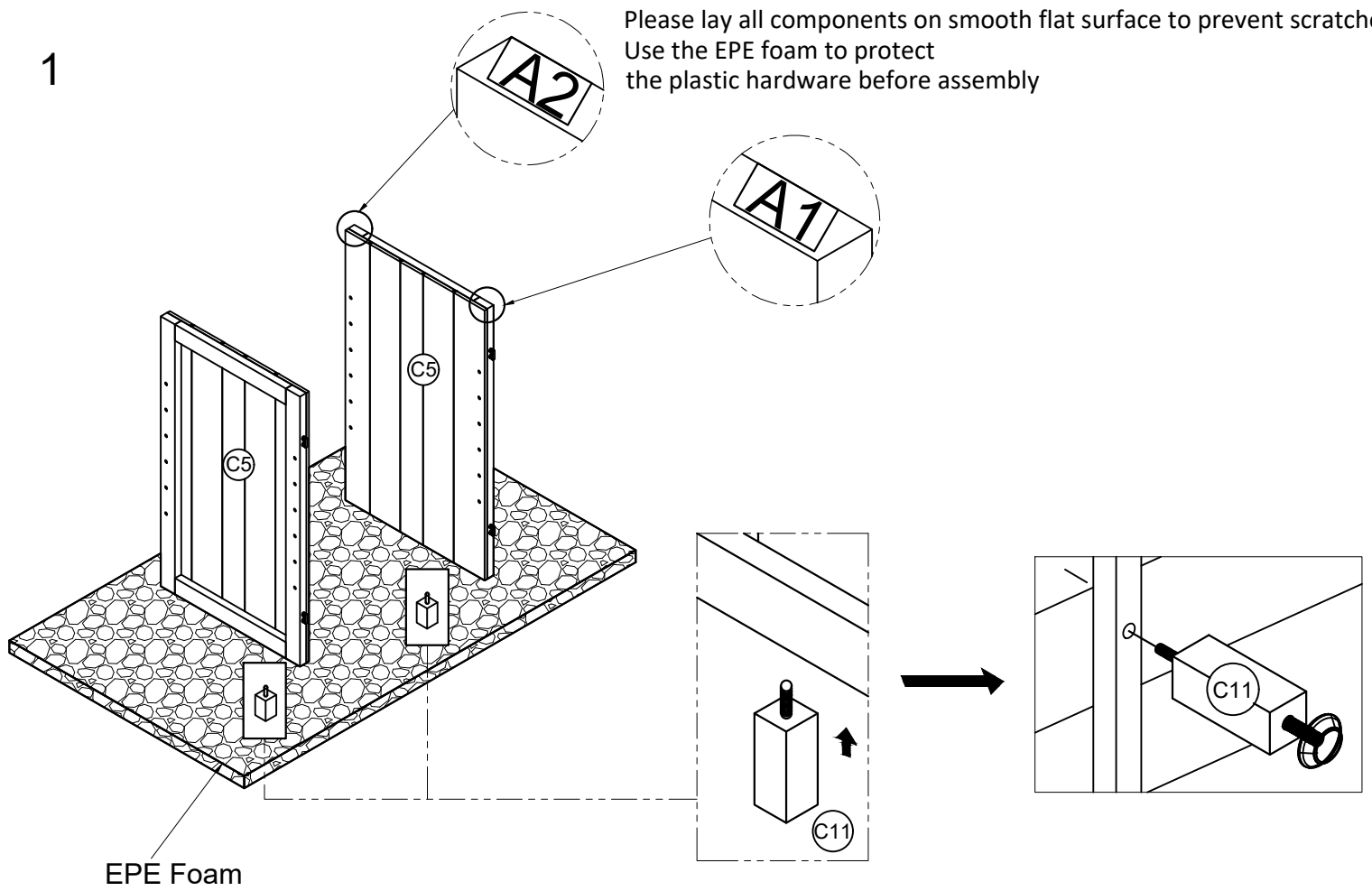

2

To assemble the two Interior Partitions (C5), please note the Framed Side of (C5) faces external and the Flat Side (C5) faces internal.

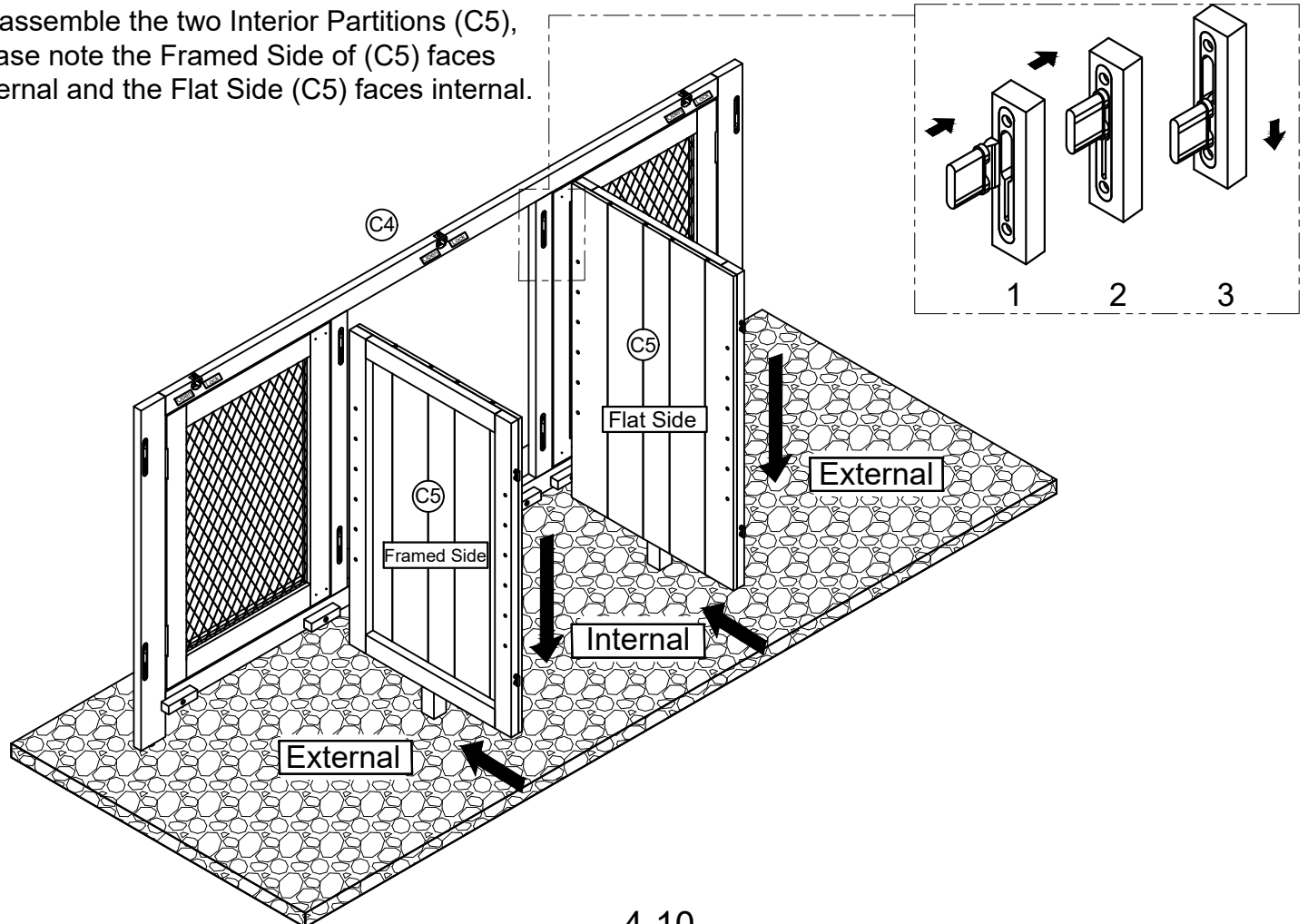

3

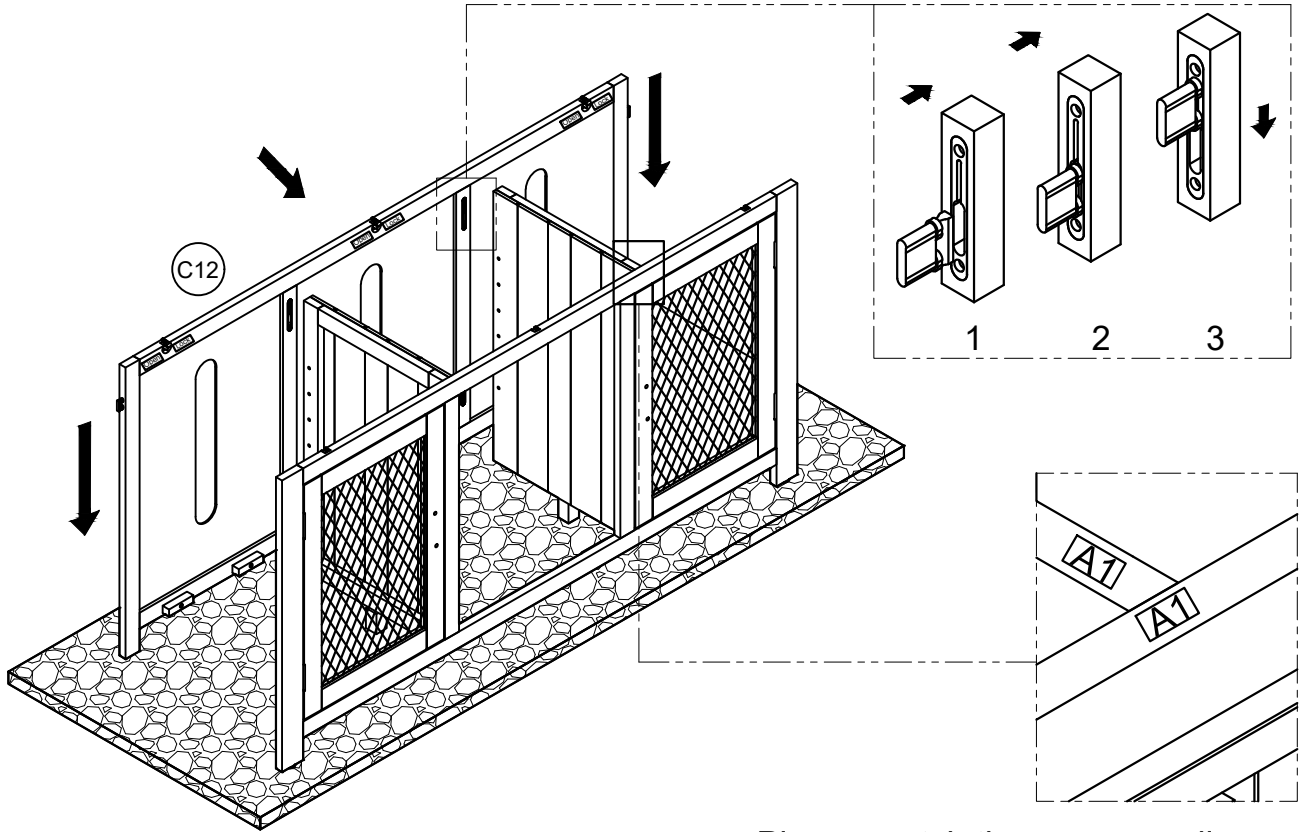

Please match the corresponding numbers up to lock into place

4

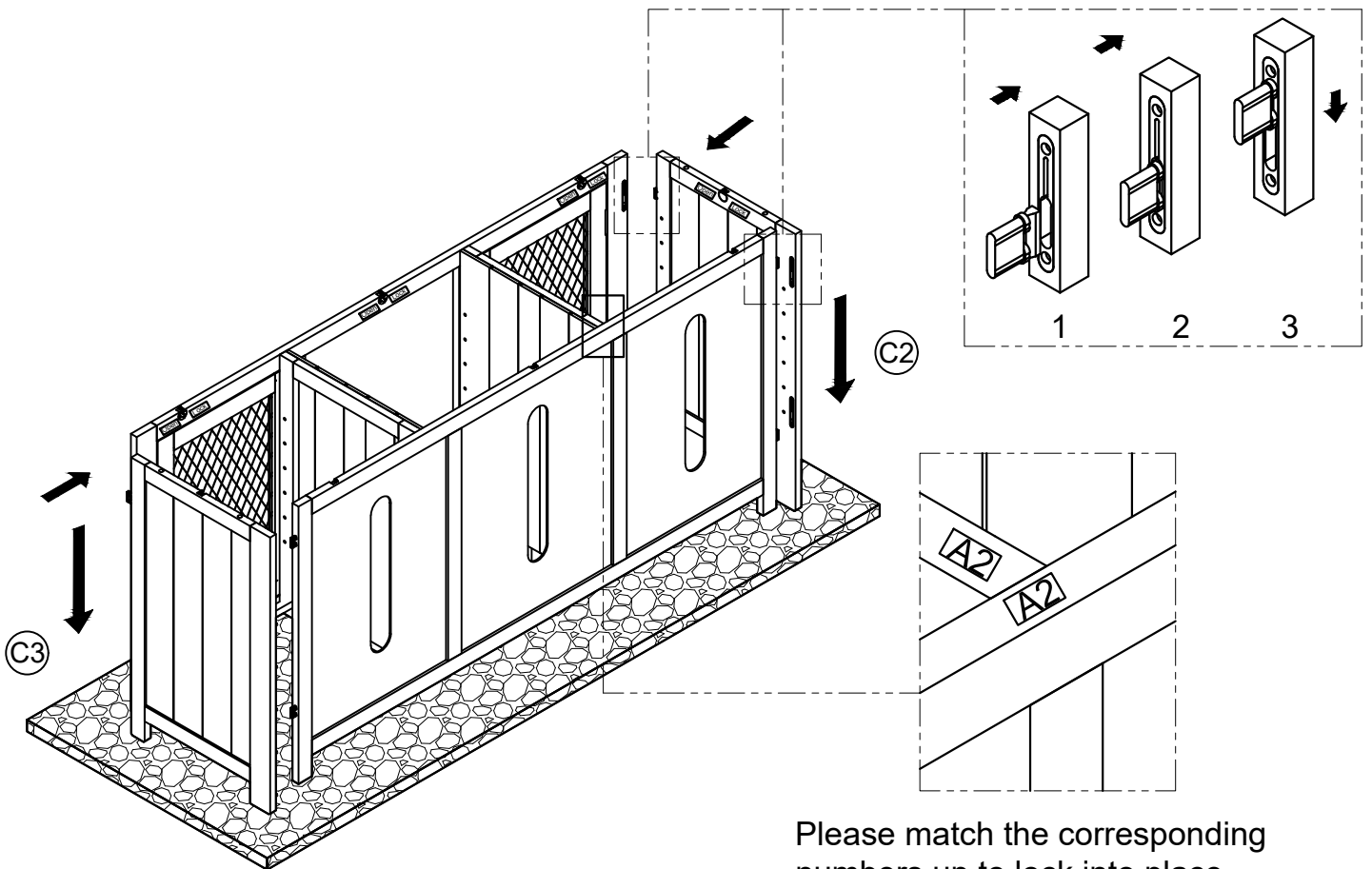

Please match the corresponding numbers up to lock into place

5

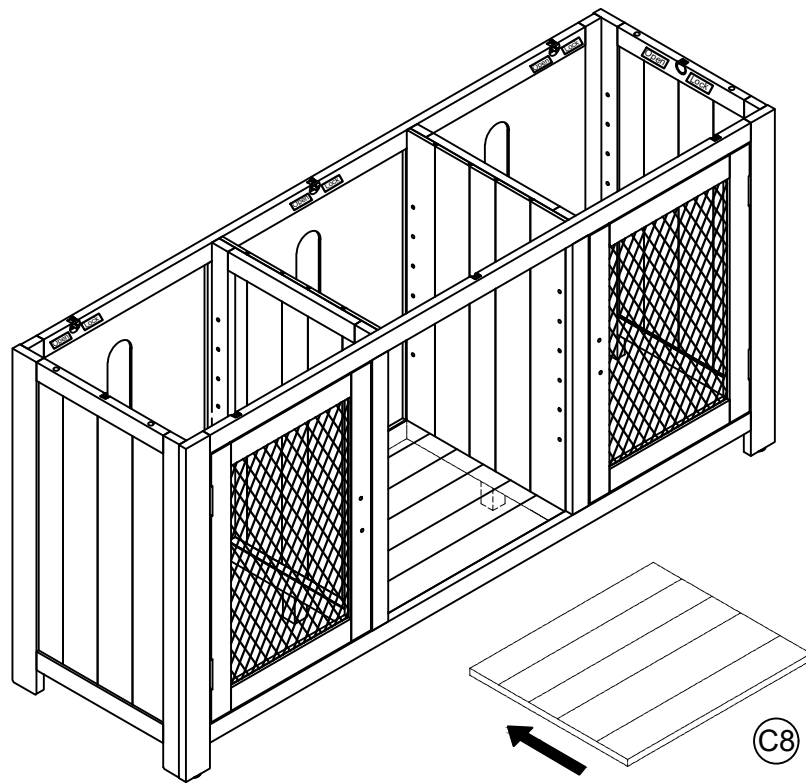

6

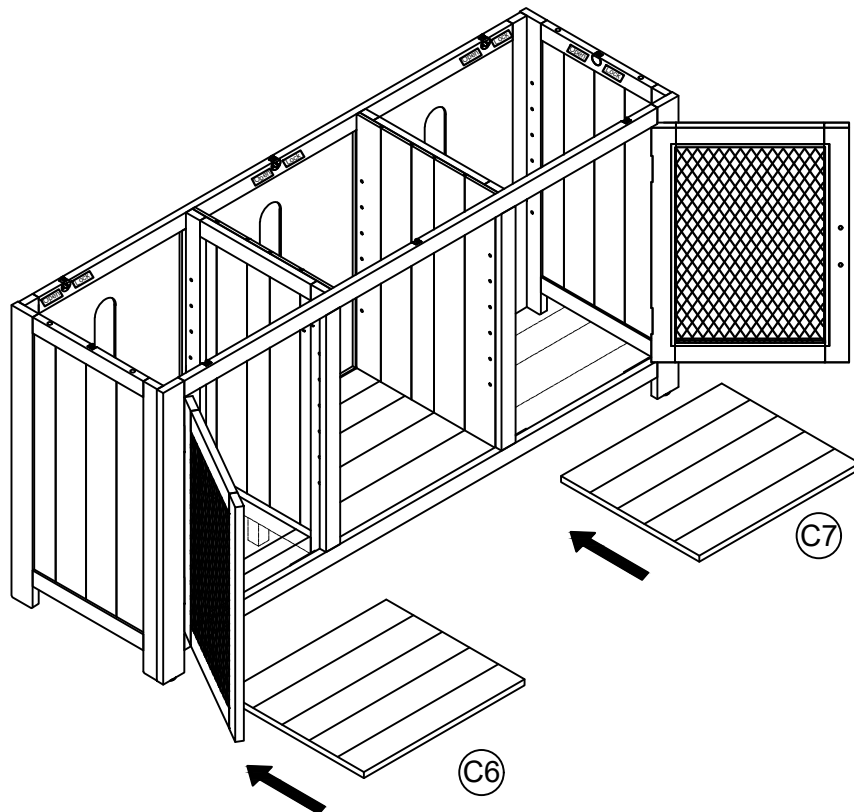

6-10

7

D x 2



E x 4

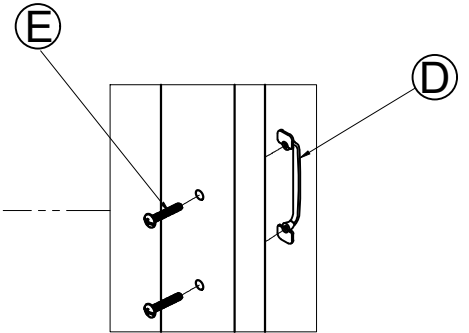
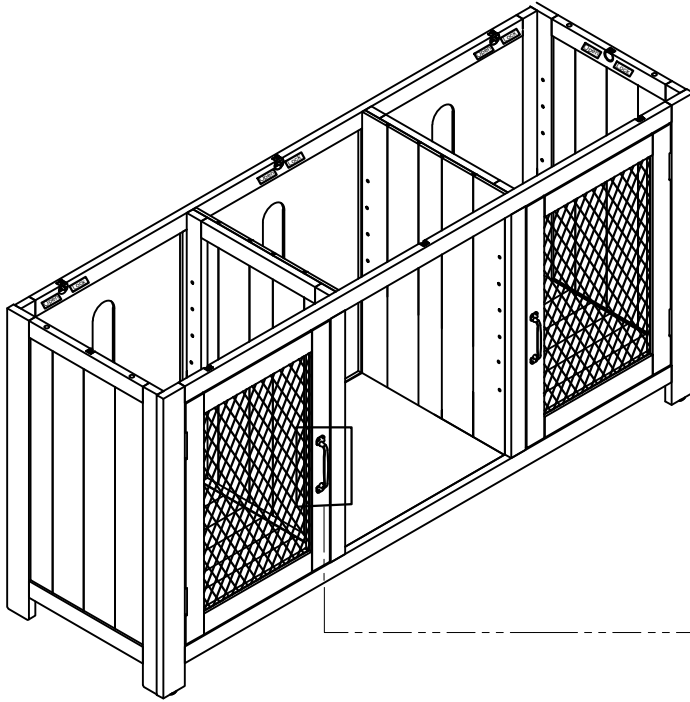
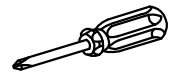

8

B x 8



C x 8

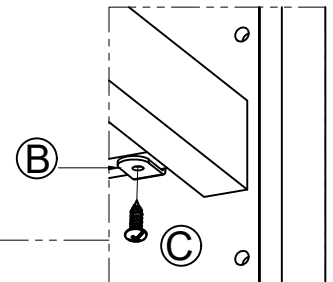
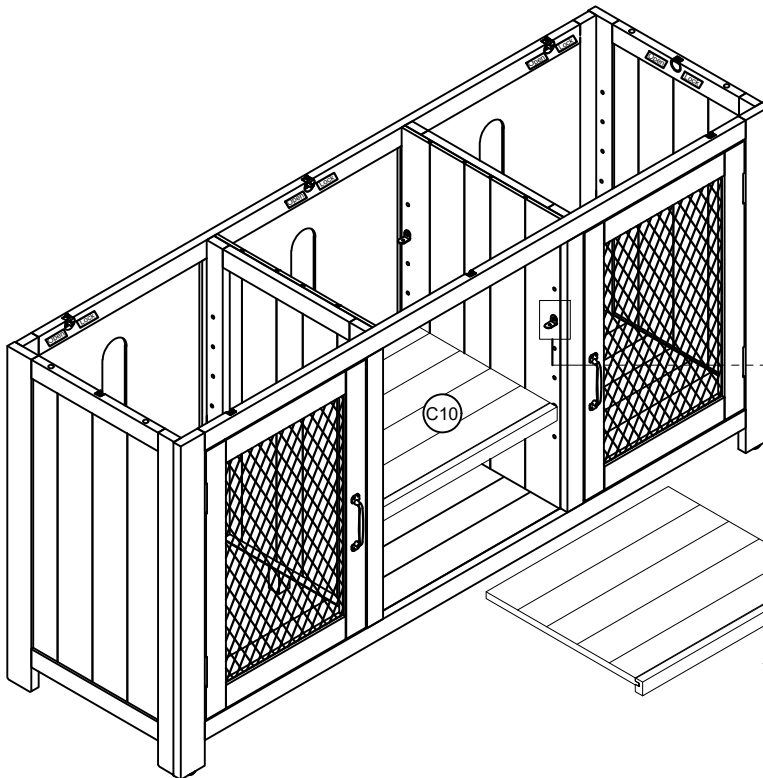

Ensure that side rail support is positioned under wood molding

Optional Shelf Support Screw-in procedure:

- Start with 1st shelf first, ensure the side rail support is positioned under wood molding.
- Remove Bottom Panel (C8) before for installing lower shelf for screw access
- Place Bottom Panel (C8) back into place once screws have been installed

9

Bx8



Cx8

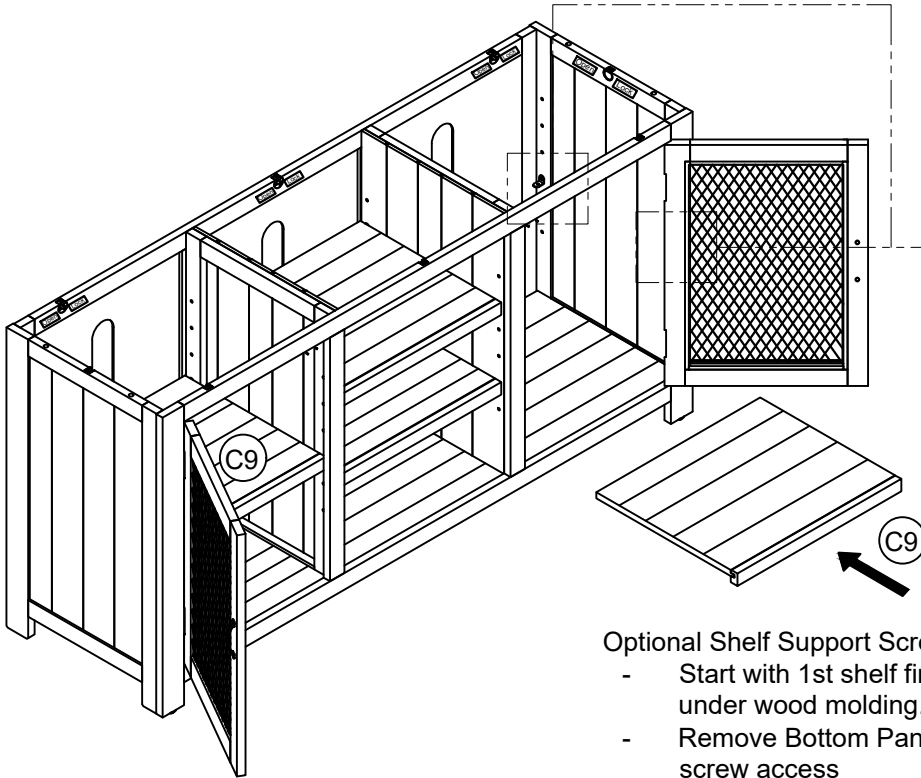

Ensure that front support is positioned under wood molding

Optional Shelf Support Screw-in procedure:

- Start with 1st shelf first, ensure the side rail support is positioned under wood molding.
- Remove Bottom Panel (C8) before for installing lower shelf for screw access
- Place Bottom Panel (C8) back into place once screws have been installed

10

Ax4

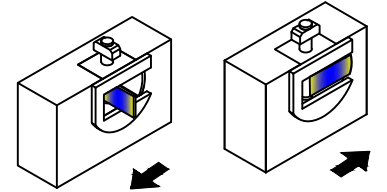
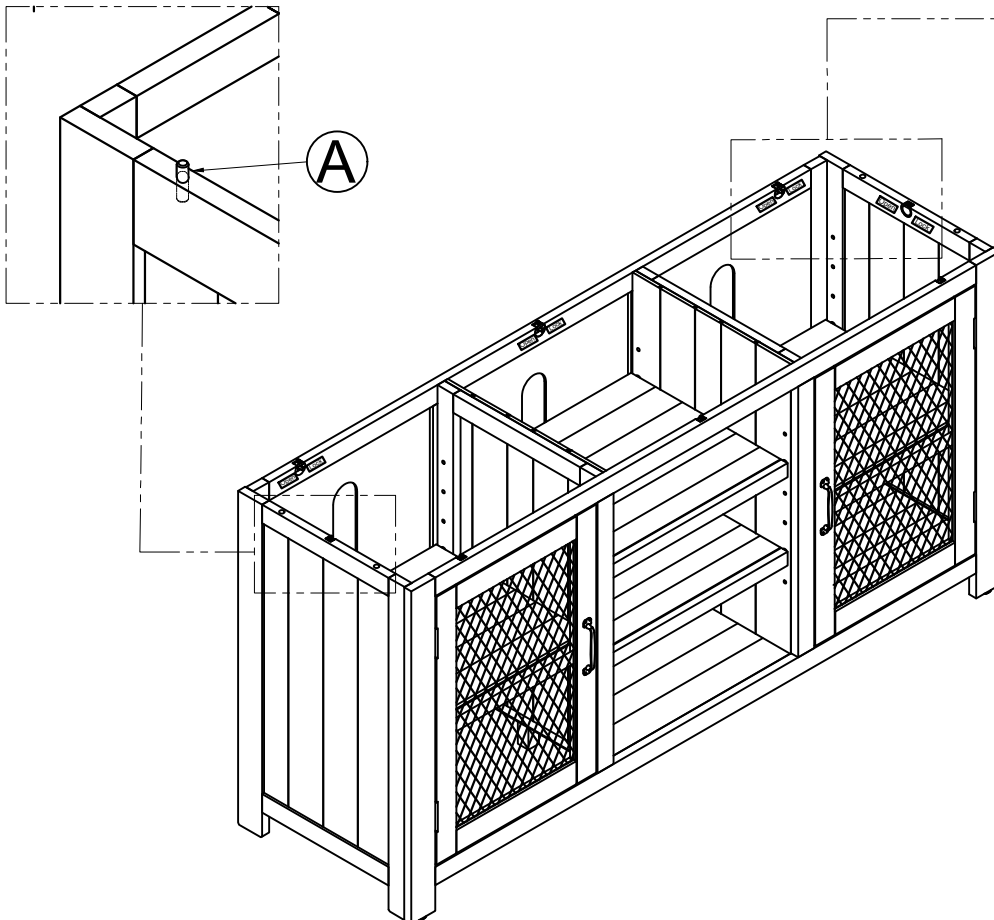

Open

Lock

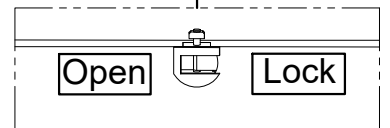

Make sure all latches are in the open position before installing Top Panel (C1)

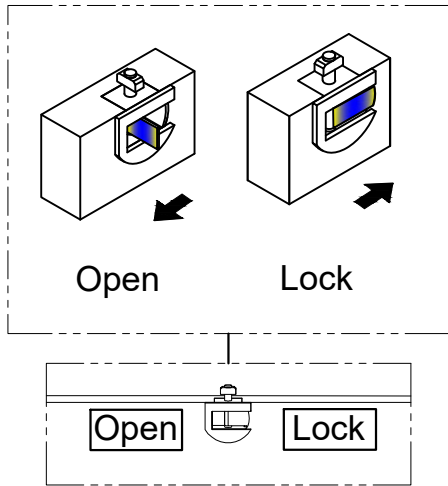

Make sure all 8 latches are in the locked position

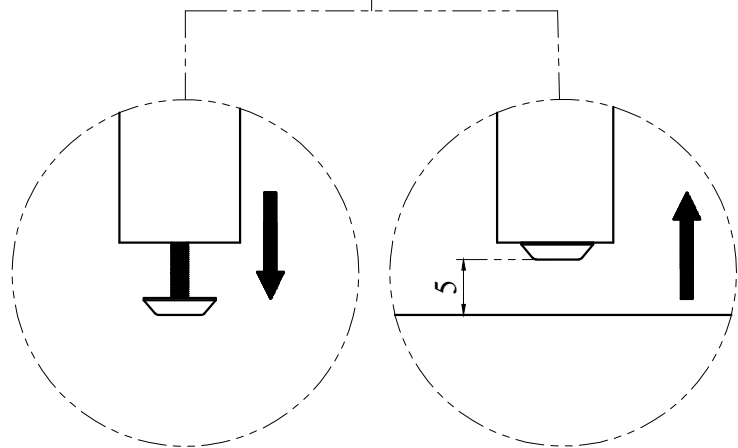
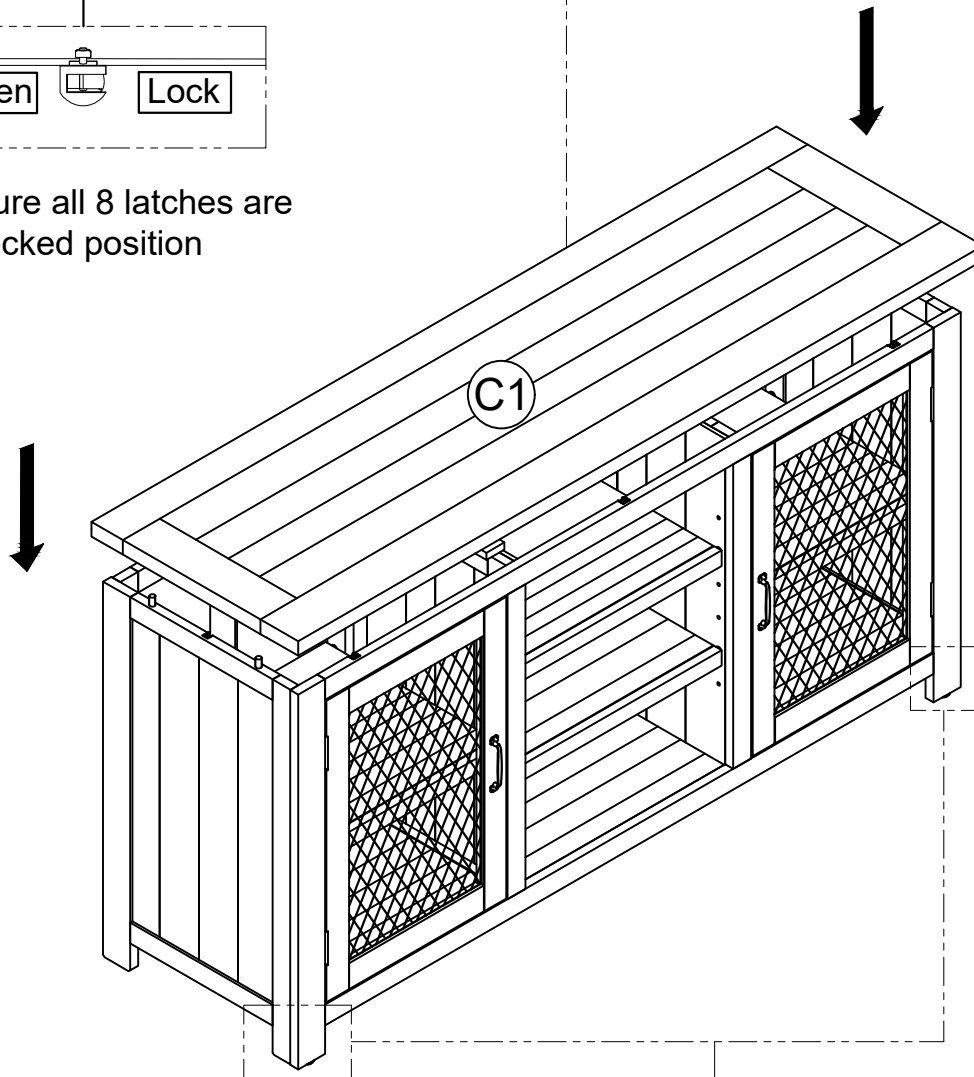

Adjustable Leveler Instructions

