

ASSEMBLY INSTRUCTIONS

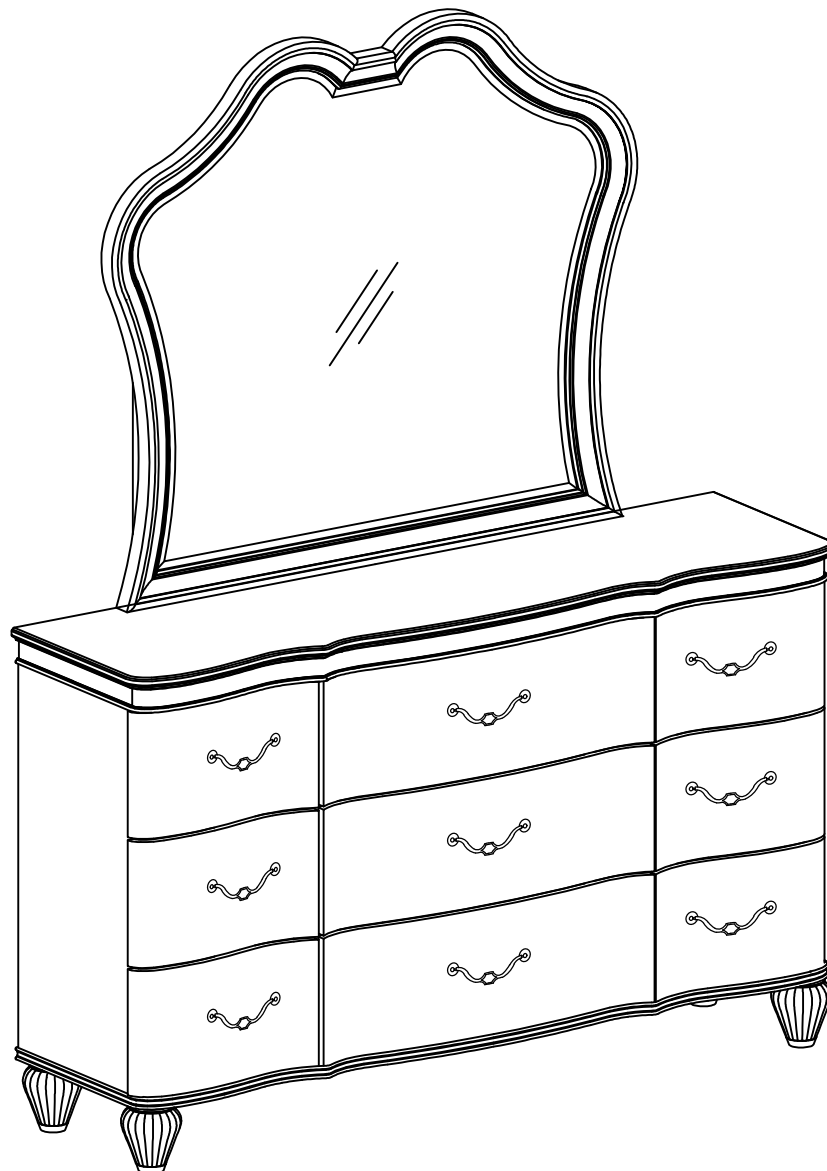





ASSEMBLY TIPS:

1. Remove hardware from box and sort by size.
2. Please check to see that all hardware and parts are present prior to start of assembly.
3. Please follow attached instructions in the same sequence as numbered to assure fast & easy assembly.



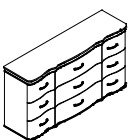

Warning!

1. Don't attempt to repair or modify parts that are broken or defective. Please contact the store immediately.
2. This product is for home use only and not intended for commercial establishment.

PARTS IDENTIFICATION

A		Dresser	1PC
B		Legs	4PCS
C		Support Leg	1PC
D		Mirror	1PC
E		Support Rail	2PCS

HARDWARE IDENTIFICATION

1		Bolt	Ø1/4"*40 (D15)	8PCS
2		Lock washer	Ø1/4"*10*1.5	8PCS
3		Flat washer	Ø1/4"*18*1.5	8PCS
4		Allen wrench	4mm	1PC
5		ANTI-TIP KIT		1SET

STEP 1.

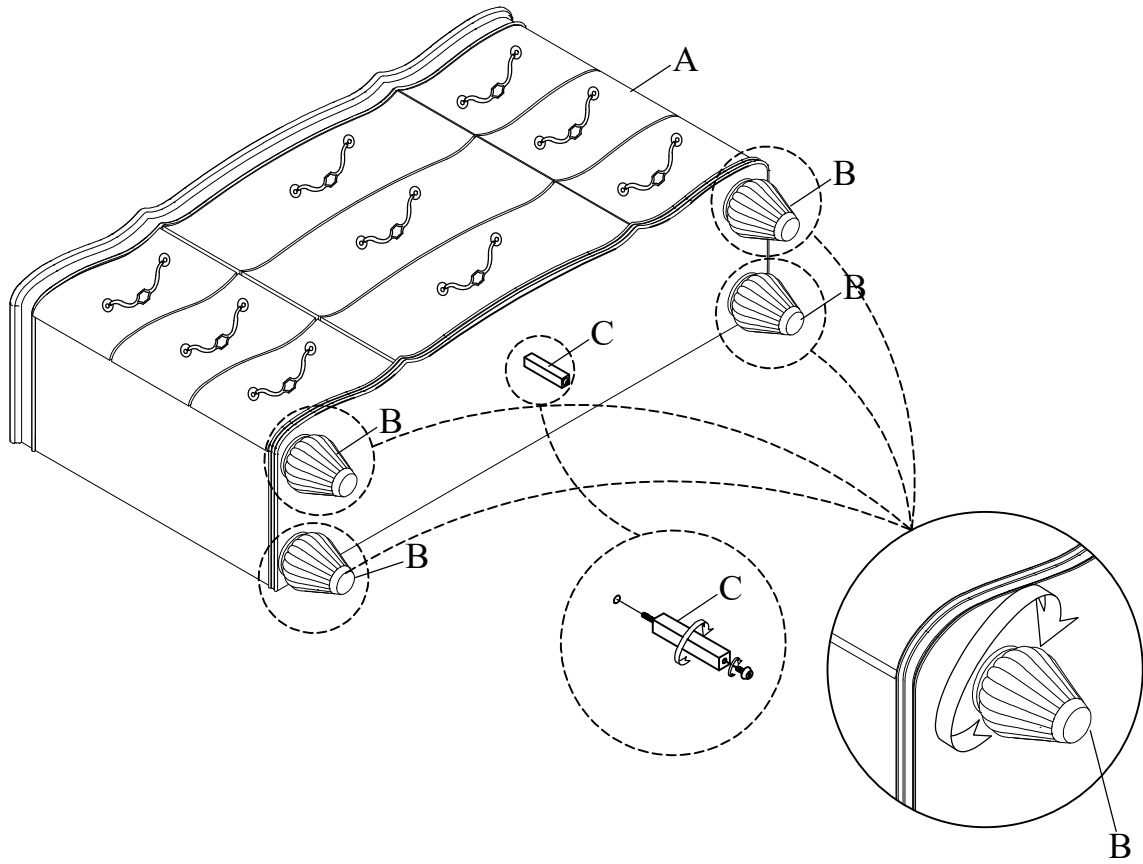

STEP 2.

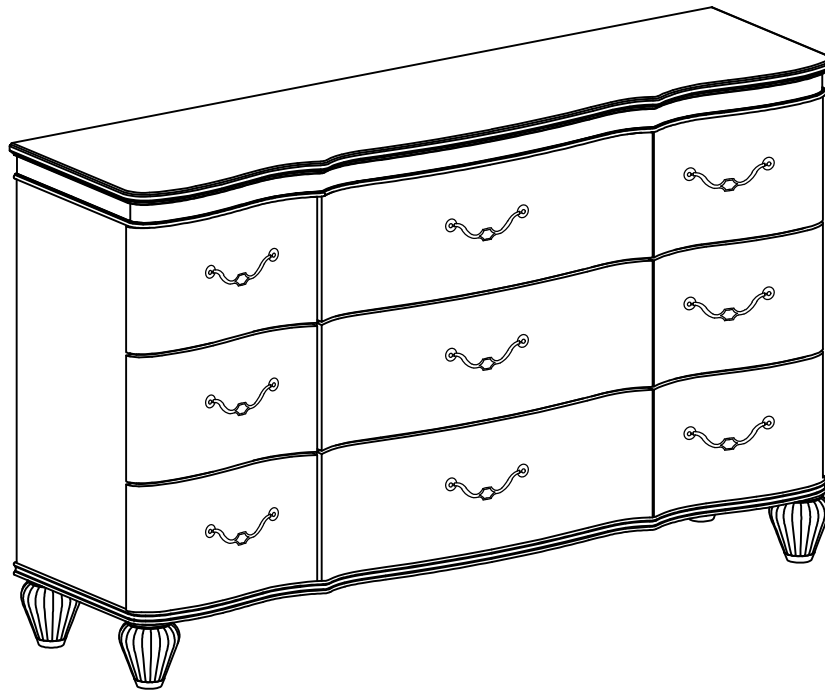

STEP 3.

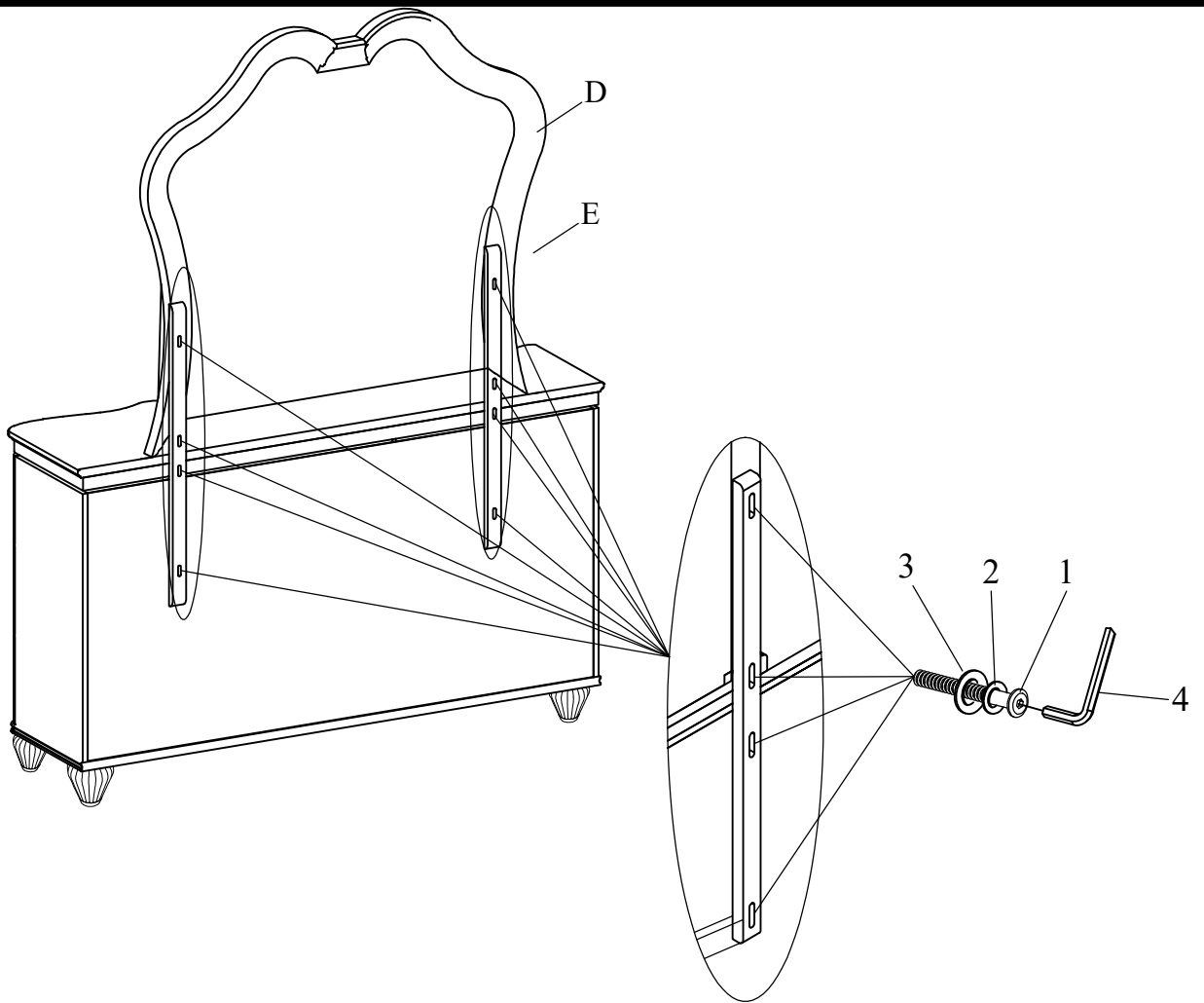

STEP 4.

