

ASSEMBLY INSTRUCTIONS

SEC-0266 SECTIONAL

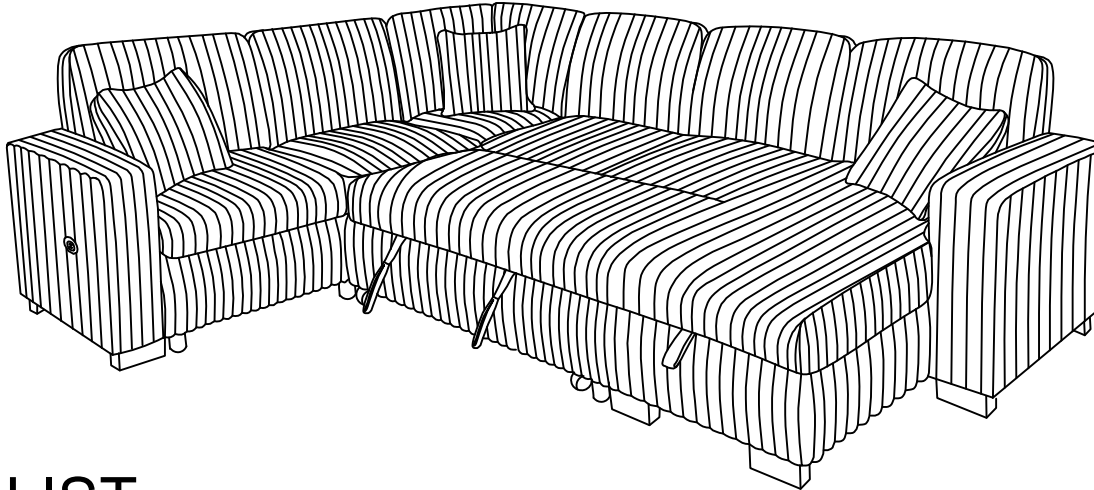









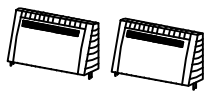
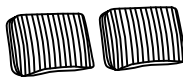





Caution: Please read instructions thoroughly before unpacking assembly parts. Sharp, exposed staple tips can cause injury, therefore, for your protection, please remove any exposed staple used in packing

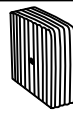
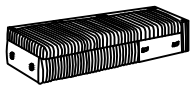

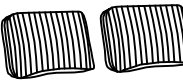
PARTS LIST

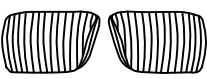
NO	SKETCH	QTY	DESCRIPTION	J	SKETCH	QTY	DESCRIPTION																
						1PC	LSF Backrest																
A		1PC	Left Arm	K		1PC	Backrest Of Wedge - Left																
B		1PC	LAF	L		1PC	Backrest Of Wedge - Right																
C		1PC	LSF	M		1PC	LSF Backrest																
D		1PC	RAF	N		1PC	RAF Backrest																
E		1PC	Right Arm	O		3PCS	Pillow																
F		2PCS	LAF Back Cushion	HARDWARE LIST <table border="1"> <thead> <tr> <th>NO</th> <th>SKETCH</th> <th>QTY</th> <th>DESCRIPTION</th> </tr> </thead> <tbody> <tr> <td>1</td> <td></td> <td>21PCS</td> <td>Screw M5 x 50mm</td> </tr> <tr> <td>2</td> <td></td> <td>6PCS</td> <td>Legs</td> </tr> <tr> <td>3</td> <td></td> <td>9PCS</td> <td>Legs</td> </tr> </tbody> </table>				NO	SKETCH	QTY	DESCRIPTION	1		21PCS	Screw M5 x 50mm	2		6PCS	Legs	3		9PCS	Legs
NO	SKETCH	QTY	DESCRIPTION																				
1		21PCS	Screw M5 x 50mm																				
2		6PCS	Legs																				
3		9PCS	Legs																				
G		2PCS	Wedge Back Cushion																				
H		2PCS	RAF Back Cushion																				
I		1PC	LSF Back Cushion																				

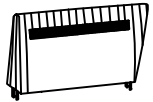
ASSEMBLY INSTRUCTIONS

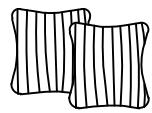
Carton	Disignation	Part	Hardware
1	LSF	C 	
	LSF Backrest	M 	
	LSF Back Cushion	H 	
2	Right Arm	E 	
	RAF	D 	 #1 x11pcs
	RAF Backrest	N 	 #2 x4pcs
	RAF Back Cushion	I 	 #3 x3pcs
	Pillow	O 	
3	Left Arm	A 	
	LAF	B 	
	LAF Backrest	J 	 #1 x10pcs
	LAF Back Cushion	F 	 #2 x2pcs
	Wedge Back Cushion	G 	 #3 x6pcs
	Backrest Of Wedge Left	K 	
	Backrest Of Wedge Right	L 	
	Pillow	O 	

ASSEMBLY INSTRUCTIONS

STEP 1

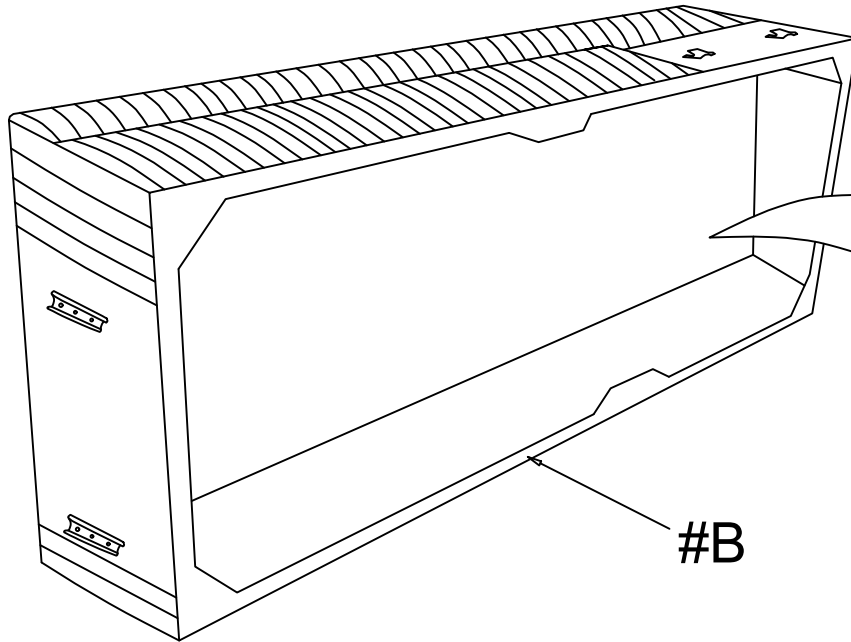

#A x 1PC

#J x 2PCS

#F x 2PCS

#G x 2PCS

#K x 1PC

#L x 1PC

#O x 2PCS

#1 x10PCS

#2 x2PCS

#3 x6PCS



STEP 2

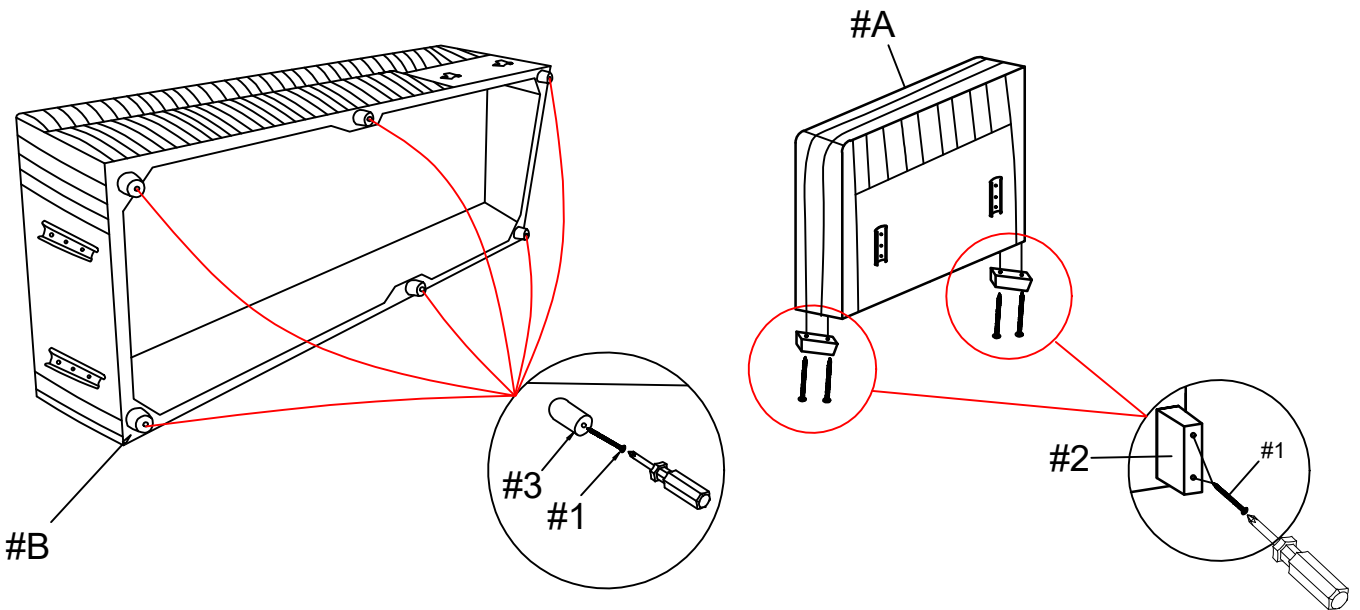

ASSEMBLY INSTRUCTIONS

STEP 5

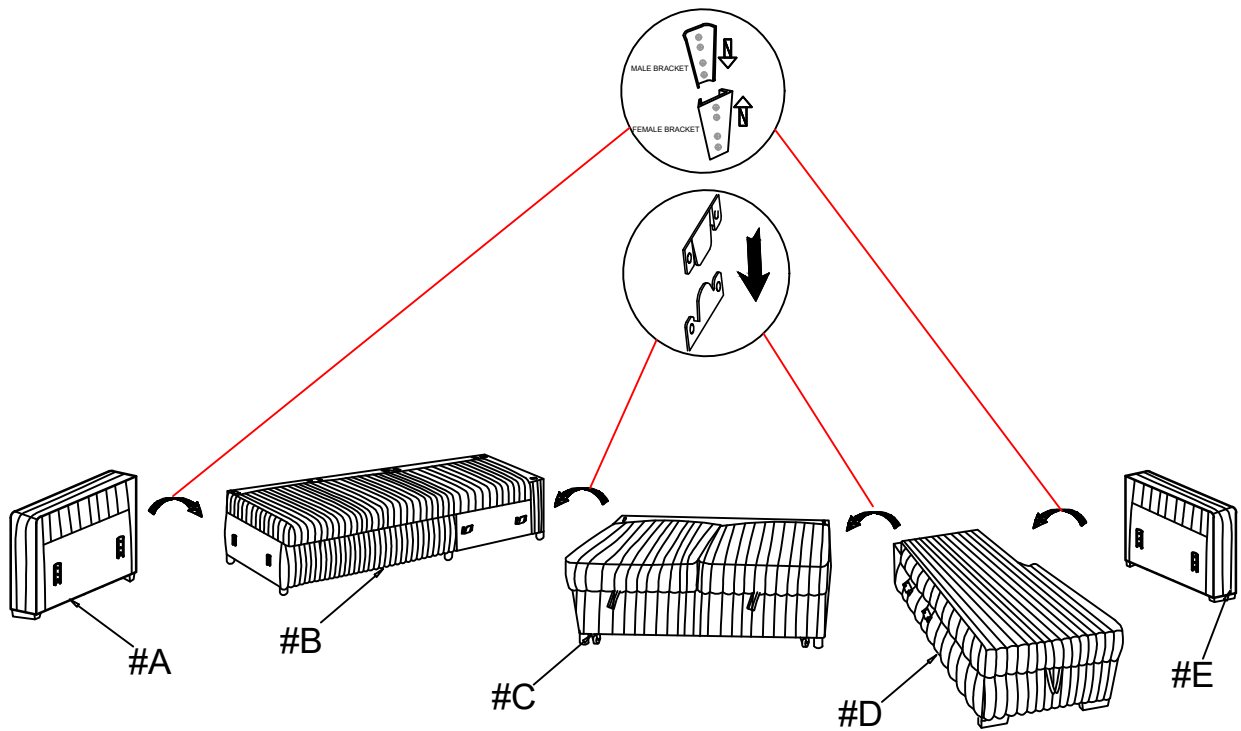

ASSEMBLY INSTRUCTIONS

STEP 6

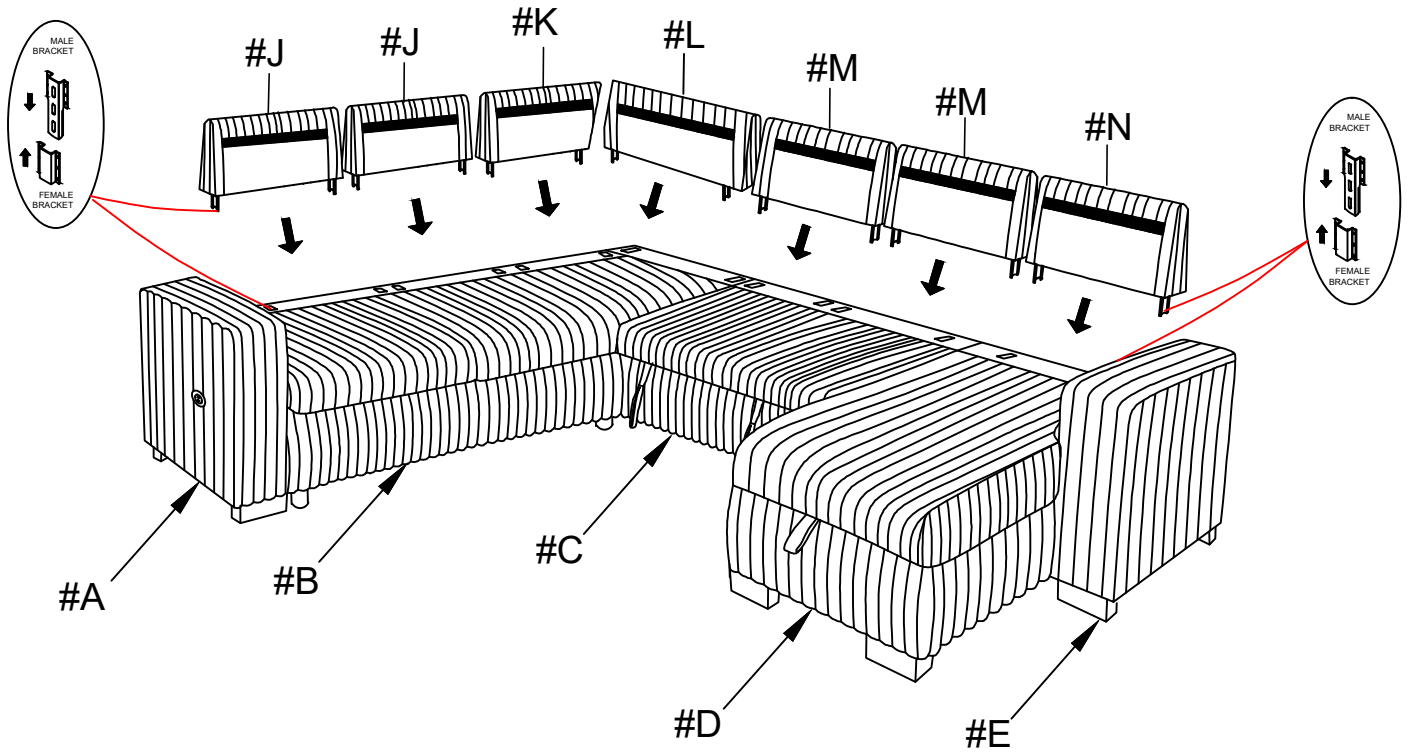

ASSEMBLY INSTRUCTIONS

STEP 7

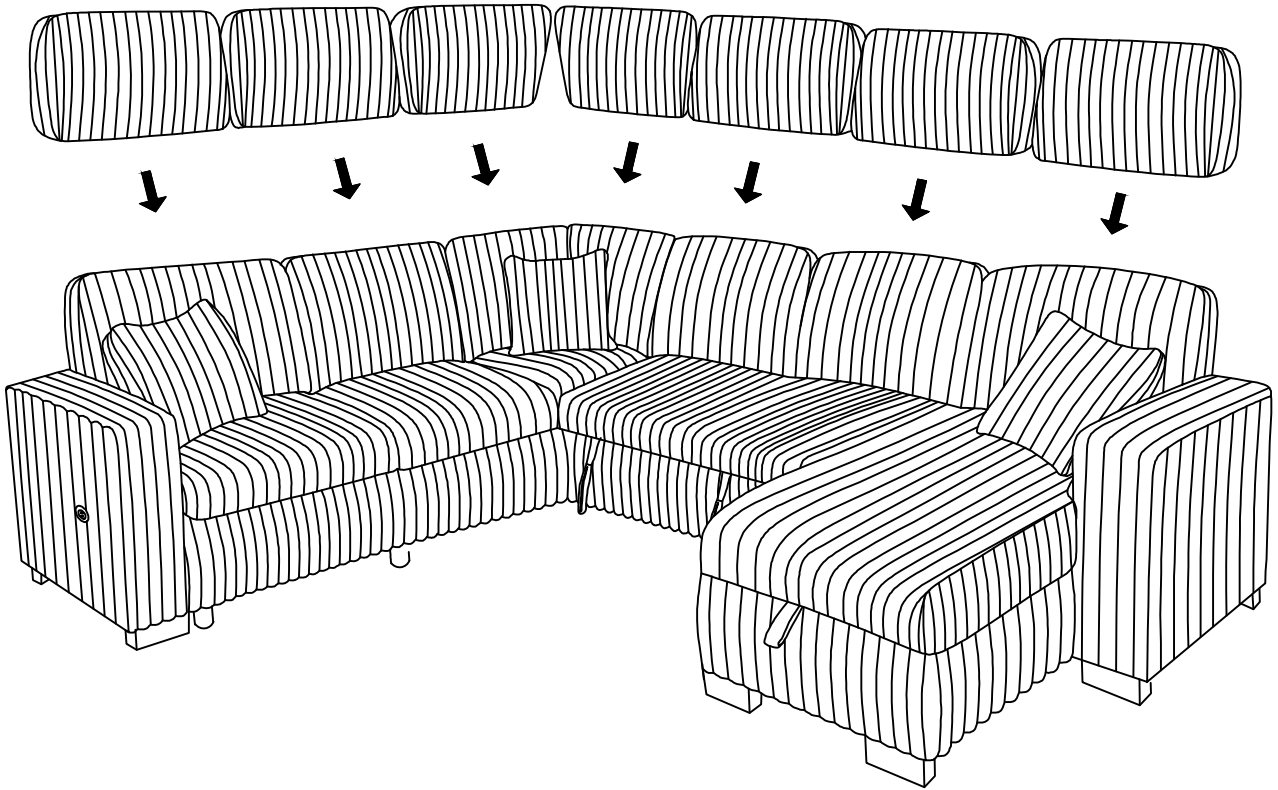

STEP 8

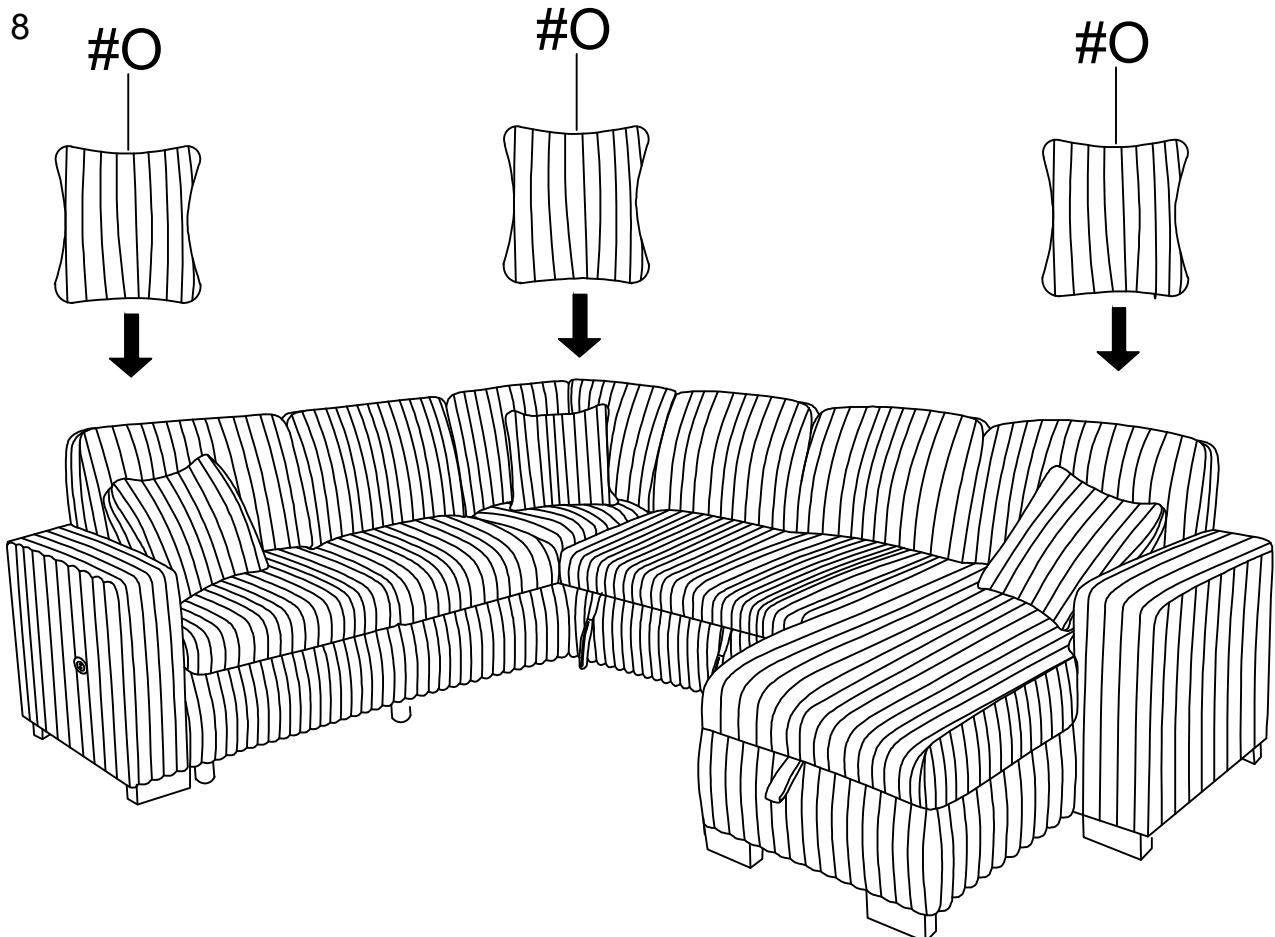

STEP 9

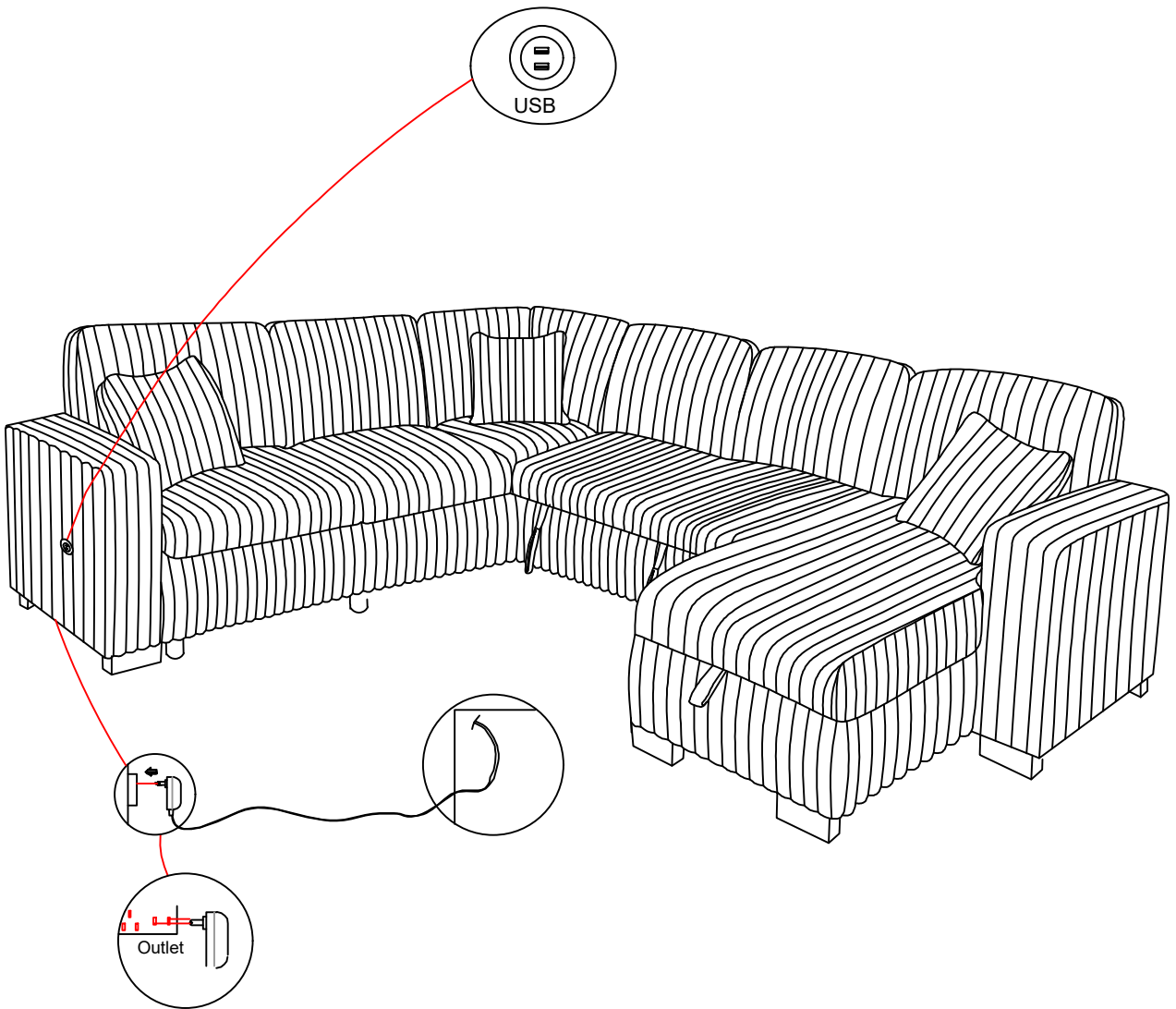

ASSEMBLY INSTRUCTIONS

STEP 10

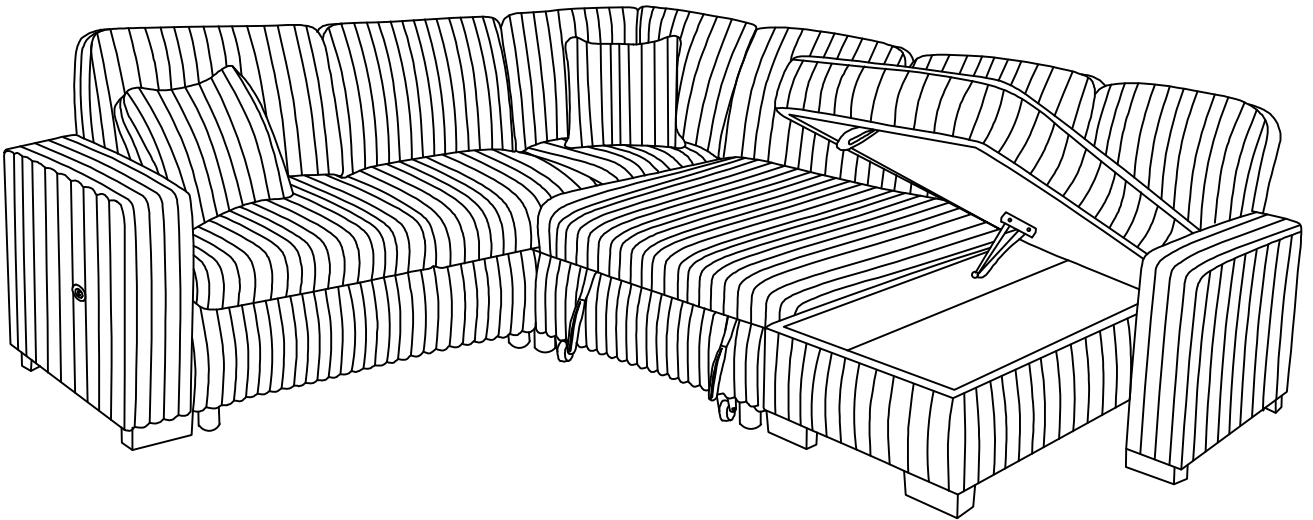



ASSEMBLY INSTRUCTIONS

- Disconnect the electrical plug from the wall outlet before cleaning, moving, servicing or when not in use for an extended period of time.
- Plug directly into a wall outlet. Do not use an extension cord or adaptor
- Check the condition of the power transformers, electrical cords, plugs and connectors monthly. Keep the power adaptor and electrical cords away from heat sources. Never operate the unit with a damaged power adaptor, electrical cord, plug or connector.
- Before moving the product, please disconnect the electrical plug from the wall outlet and secure the mechanism to prevent unexpected opening or movement. Never move the product by the mechanism, legrest, handle, or reclining back. Do not attempt to disassemble or service the adaptor or motor. No serviceable parts are inside.
- Do not allow electrical cord to be pinched between moving parts or between the frame and the floor.
- Do not place cord under carpet or in location where it could become worn.
- Unplug the power cord immediately if you detect strange odors or fumes coming from the chair.

PLEASE KEEP ASSEMBLY INSTRUCTION FOR FUTURE REFERENCE