













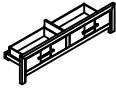

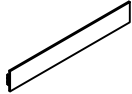

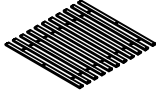

ASSEMBLY INSTRUCTIONS

DESCRIPTION: FULL & QUEEN STORAGE BED

Thank you for purchasing this quality product.
 Please read instructions carefully prior to assembly.
 Check carefully for small parts which may have come loose during transportation inside all the boxes.
 Remove from boxes and place all parts and components on soft surface such as carpet, blanket or furniture pad. Identify and verify all parts and hardware as specified below.

PART LIST				Hardware List For Headboard			
A		Headboard Panel	1PC	1		ALLEN KEY (L59*4mm)	1PC
B		L/R Posts	2PCS	2		JCBC BOLT (Ø5/16*35mm)	8PCS
C		Storage Footboard	1PC	3		SPRING WASHER (Ø5/16*12*2mm)	8PCS
D		Side Rails	2PCS	4		FLAT WASHER (Ø5/16*19*2mm)	8PCS
E		Slat Roll	1SET (11pcs)	Hardware List For Footboard			
F		Slats	2PCS	1		ALLEN KEY (L59*4mm)	1PC
G		Headboard Bottom Stretcher	1PC	2		JCBC BOLT (Ø5/16*35mm)	2PCS
H		Long Support Leg for bed slats	4PCS	3		SPRING WASHER (Ø5/16*12*2mm)	2PCS
I		Center Slat	1PC	4		FLAT WASHER (Ø5/16*19*2mm)	2PCS
				5		Wood Screw (Ø4*30mm)	26PCS

Assembly Tips:

- * Do not tighten screws and bolts until final steps of the assembly
- * This assembly may require additional help (2 person set up)

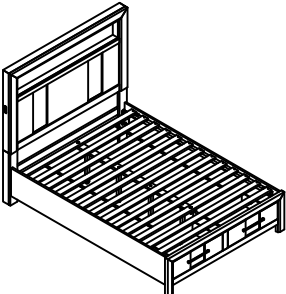
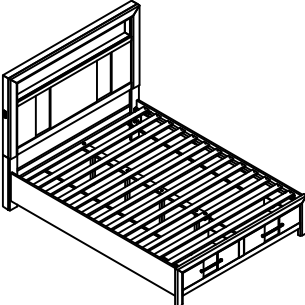
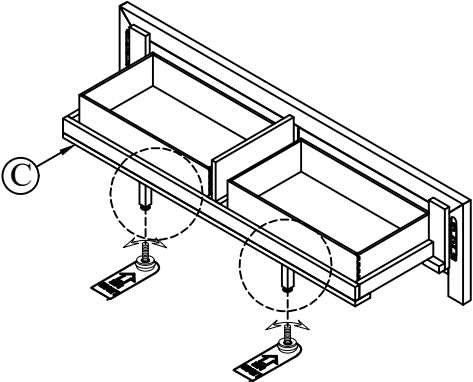
<p>Full storage bed</p> 	<p>Queen storage bed</p> 	 <p>STEP-1</p>
-------------------------------------------------------------------------------------------------------------	--------------------------------------------------------------------------------------------------------------	-----------------------------------------------------------------------------------------------------------

ASSEMBLY INSTRUCTIONS

DESCRIPTION: FULL & QUEEN STORAGE BED

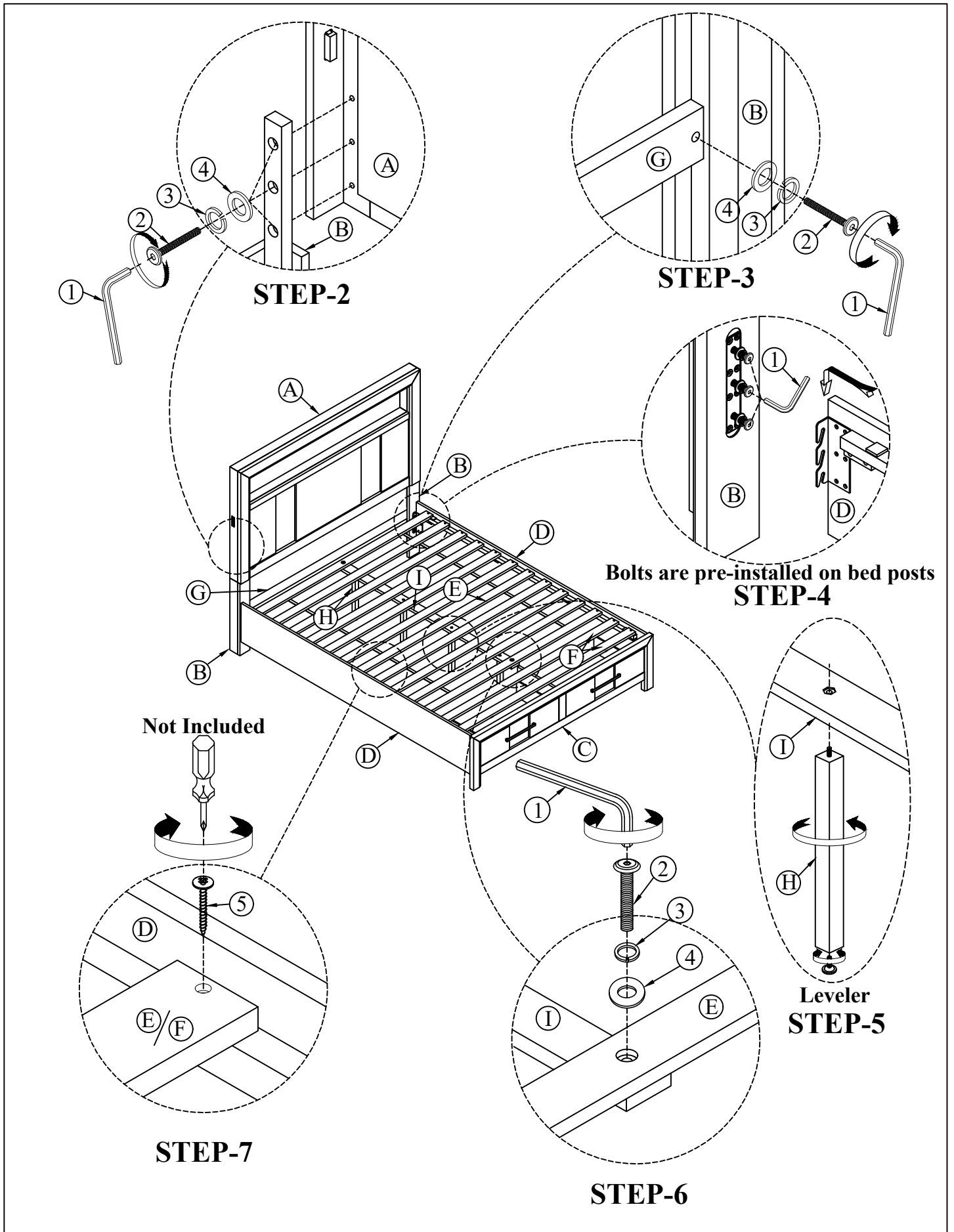

ASSEMBLY INSTRUCTIONS

DESCRIPTION: FULL & QUEEN STORAGE BED

CARING FOR YOUR FURNITURE

Fine wood furniture is a treasured possession in any home, and with good care, it can last for generations. Upholstered furniture provides us with comfort, color and texture. Who doesn't love sinking into the cushioned softness of a favorite sofa?

Fine wood furniture

Care for fine furniture with these recommendations:

Avoid heat and light. In a natural state, wood contains a surprising amount of moisture. Preserving appropriate moisture levels is key to the preservation of furniture. Accordingly, position wood furniture away from heating vents, fireplaces or radiators. Don't store furniture in attics, where temperature and humidity levels vary widely from summer to winter, day and night. Avoid placing furniture in areas where it will sit in direct sunlight, which can fade fine furniture; use drapes, sheers or protective window films to guard against the sun's rays. Protect from damage. Everyday life can be hard on wood furniture. Moisture from sweating beverage glasses leaves round rings in the finish, while the heat from a hot dish can ruin the wood finish beneath. Provide cork- or felt-bottomed coasters if you will set glasses or mugs on wood, and always use trivets to support hot serving dishes. Place mats, tablecloths or padded table covers protect dining room tables from spills or scrapes. Clean safely. Dust frequently. Occasionally, wood furniture will require heavier cleaning. Using a natural sponge, moisten it with oil soap and wring out most of the water. Gently stroke the furniture to loosen soil. Rinse the residue from the wood with a sponge wrung out in clear water, and then dry the piece with fresh cleaning cloths. Dust furniture often with barely damp white cotton cleaning cloth. Microfiber cloths do a good job of attracting and removing fine blown-in soil. Avoid using a feather duster, as a broken quill can scratch and damage delicate finishes. Dust damp. Dusting with a dry cloth can scratch, so lightly spritz your cleaning cloth with water, a spray dusting agent or wood polish. Never spray furniture directly, as over-spray can leave a difficult-to-remove film. Follow the grain of the wood as you dust to avoid cross-grain scratches.

Frequent dusting removes dirt before it has a chance to settle in and make itself at home.

Upholstered furniture

Dust and dirt act like sandpaper on furniture fabric, so remove it frequently. Vacuum upholstered furniture weekly; lift cushions and use the crevice tool to remove hidden crumbs beneath. Keep upholstered furniture looking new with these tips:

Flip, swap and rearrange. Being territorial creatures, most humans gravitate to their favorite places but when it's the same seat on a long sofa day after day, that preference will start to show. Flip loose cushions regularly, and rotate them on a multi-cushion unit. Similarly, rearrange upholstered furniture once or twice a year to distribute wear more evenly. Switch the position of a love seat and a sofa, or swap the positions of a set of chairs as the seasons change. Arm caps. Places where bare skin or hair come to rest — armrests, chair backs, seat cushions — are subjected to higher levels of soil and abrasion. Protect high-contact areas of upholstered furniture with arm caps tailored to fit snugly over chair and sofa arms. Slipcovers. In areas with hot summer weather, consider washable slipcovers. Traditionally applied to furniture during the warm season, slipcovers protect against sweat, suntan oil and other summer hazards. Fabric protection. Spray-on fabric protectors coat fibers and protect upholstery from spills and stains. Fabric protectors can be applied at the mill as the fabric is processed, by the furniture retailer, or at home using commercial spray products. If you apply fabric protection yourself, read the product instructions and observe safety procedures carefully.

Caring for leather furniture

Leather upholstery can last for many years if looked after correctly. Follow these tips to take good care of leather furnishings: Keep away from heat and light. Leather furniture is very sensitive to heat and sun damage. Position it away from windows, and from heat sources such as fireplaces, radiators and central heating vents. Uncoated leathers. Furniture made from uncoated leathers should be dusted frequently. An art gum eraser may remove some stains or deposits safely, but do not use leather creams, conditioners or saddle soap on uncoated leather, since these products can change the color or appearance of the leather. Coated leathers. Vacuum regularly to remove surface soil. Commonly, leather creams or conditioners may be used to clean coated leather once or twice a year. Test leather cleaners in an inconspicuous spot before using.

Avoid unsuitable products. Never use oil, furniture polish, dusting sprays or ordinary stain removers on leather furniture.