













Assembly Instructions for QUEEN BED

Caution: Please read instructions thoroughly before unpacking assembly parts. Sharp, exposed staple tips can cause injury, therefore, for your protection, please remove any exposed staples used in packing.

1. We recommend that you should assemble this product with the assistance of another person; this will make assembly easier, and will help to eliminate damage to the product or injury to persons during assembly.
2. Be sure to check all packing materials carefully for small parts that may have come loose inside the carton during shipment.
3. Please do not over tighten screws or bolts.
4. Please put all parts on a non-abrasive floor before assembly, and follow the assembly steps to assemble your newly purchased product correctly and efficiently.

No.	Parts List		Q'Ty
A		Headboard Panel	1 piece
B		L/R Posts	2 pieces
C		Footboard	1 piece
D		Side Rail	2 pieces
E		Bed Slat	4 pieces
F		Slat Support Leg	4 pieces
G		Headboard Bottom Stretcher	1 piece
G		Bun Feet	2 piece

Hardware List for Headboard			
1		Allen Key (L57*4mm)	1 piece
2		JCBC Bolt (Ø5/16" * 60mm)	8 pieces
		Spring Washer (Ø5/16" * 13 * 1.2)	8 pieces
		Flat Washer (Ø5/16" * 19 * 1.8)	8 pieces
3		JCBC Bolt (Ø1/4" * 38mm)	2 pieces
		Spring Washer (Ø1/4" * 13 * 1.2)	2 pieces
		Flat Washer (Ø1/4" * 19 * 1.8)	2 pieces

Hardware List for Headboard			
1		WRENCH 1/2"*90mm	1 piece
2		FULL - THREAD BOLT 5/16"*80mm	8 pieces
3		U WASHER. 5/16"	8 pieces
4		NUT 5/16"	8 pieces

Hardware Bag for Footboard			
4		Wood Screw(Ø4*25mm)	8 pieces

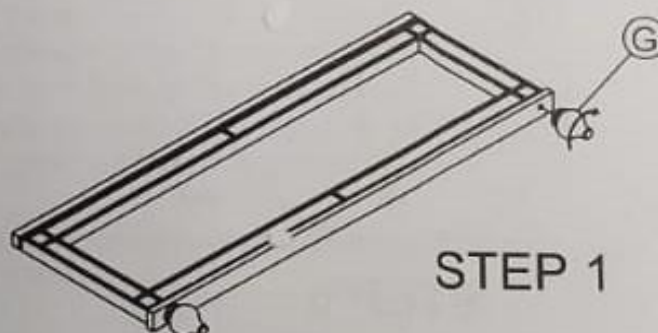
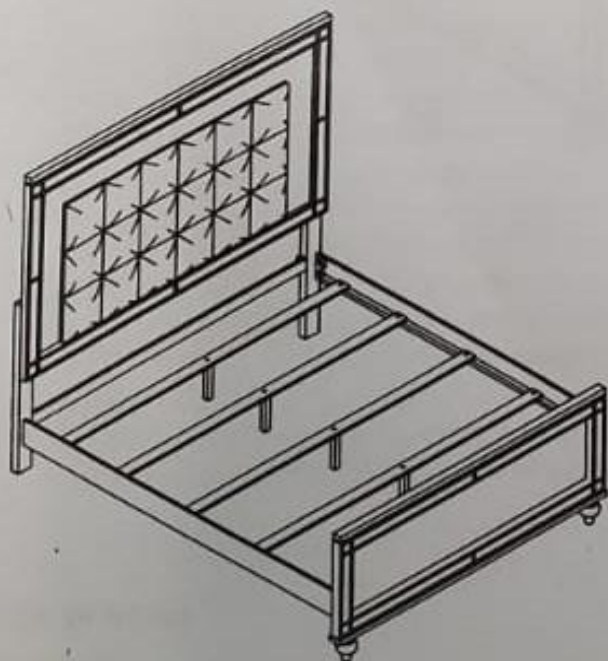

STEP 1

Assembly Instructions for QUEEN BED

PAGE 2 OF 1

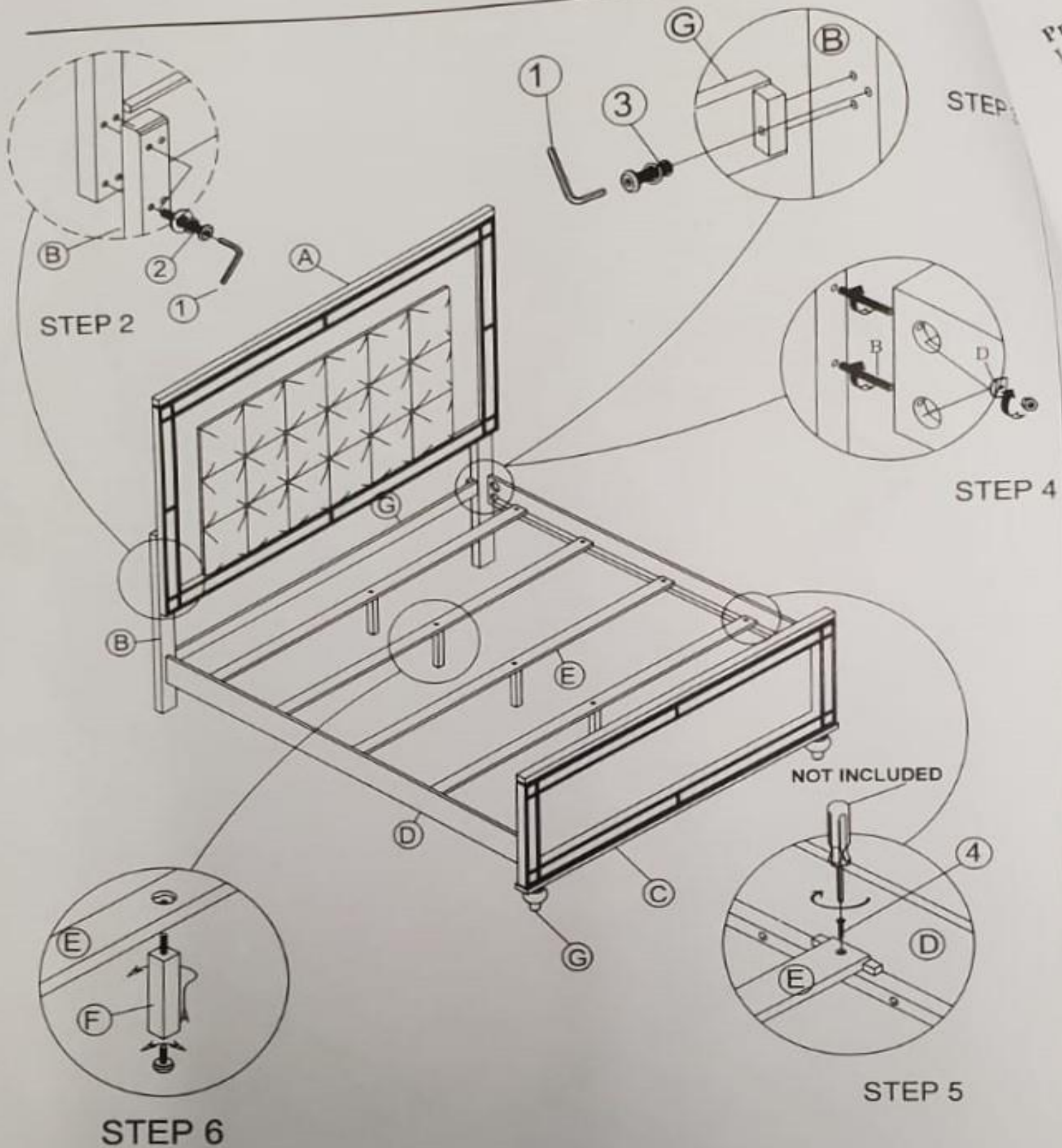

MADE IN VIETNAM

CARING FOR YOUR FURNITURE

Protect your investment

- The beauty of furniture care is that it helps to protect your investment, as fine furniture is an important purchase
- Proper care will help maintain your furniture's finish and ensure that it looks great year after year

• Caring for furniture

- Caring furniture is easy. Following a few simple guidelines will help extend the life of your furniture
- Always dust with a cloth moistened with polish. Polish cushions the cloth, eliminating the scratching that occurs with dry dusting. Dust will scratch furniture if not removed quickly. Use a soft clean cloth that won't scratch the surface. Avoid coarse or scratchy materials or fabrics
- Avoid using soap and water on furniture. Water can penetrate the finish and raise the grain on wood that cause damage to furniture.

• The Enemies Of Furniture

- Many common problems in furniture care are caused by the elements. If you are aware of these trouble makers the resulting damage can easily be avoided
- Sunlight's ultraviolet rays can damage wood finishes. Arrange furniture out of direct sunlight use sun screening intense sunlight hours rotate furniture in place and room arrangement
- Liquid spills will damage furniture if not removed promptly. Use coasters under beverage glasses and saucers under cups and flowerpots. If a spill occurs. Immediately blow it gently with out rubbing the surface.
- Heat creates a chemical change in the furniture finish. Which can result in a white spot. Use protective mats under hot dishes, utensils or cooking appliances
- Cyclic changes in temperature can damage furniture. Placing furniture near to central heating radiator and air dust should be avoided because this causes extreme localized drying of the wood

• Tips For Better Dusting

- Be sure to use the same type of polish consistently. Your furniture will appear cloudy or streaky if oil based or wax based polishes are interchange
- Always use a fine furniture polish when dusting. Never dry dust as it could cause scratches on your furniture's surface. Remember to change dusting cloths frequently since a dirty cloth may scratch your furniture's surface.
- Spray your furniture surface evenly but not too generously. Wipe in a circular motion with a soft clean cloth.
- Then buff until completely dry for a beautiful shine and smudge free finish. For wood trim spray polish on the cloth first then dust.