

ASSEMBLY INSTRUCTIONS

SKU: K5770-01/09&K5338-01/09

STEP 1

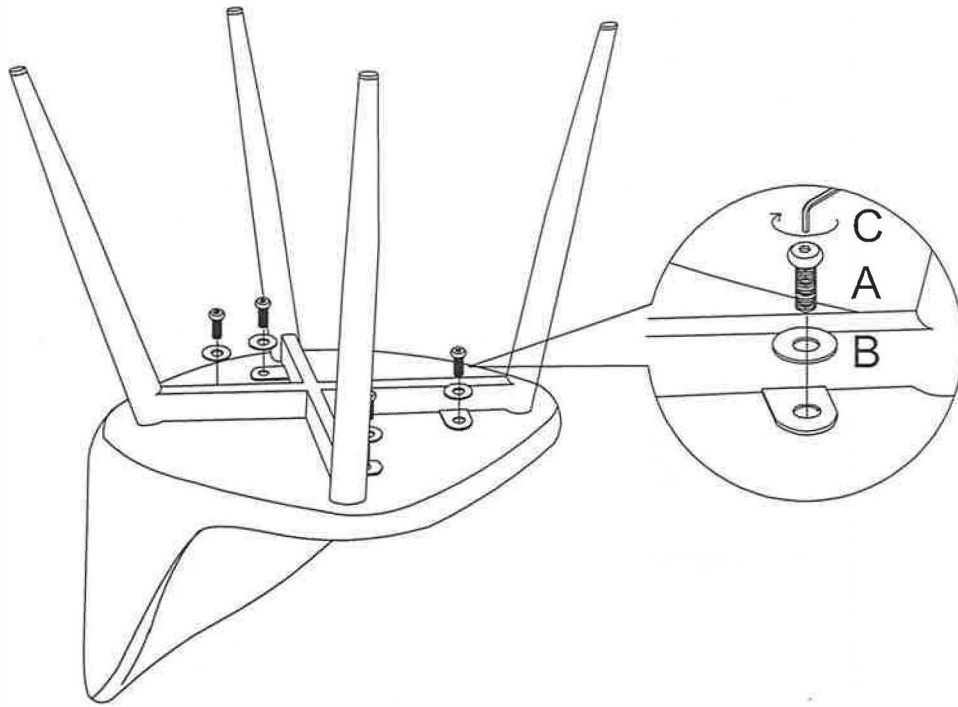

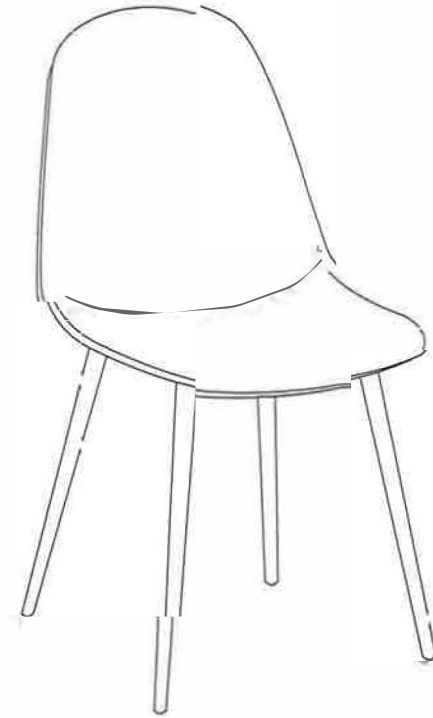

STEP 2







NOTE: Please do not tighten all bolts or discard cartons and packaging material until assembly is completed, thank you!

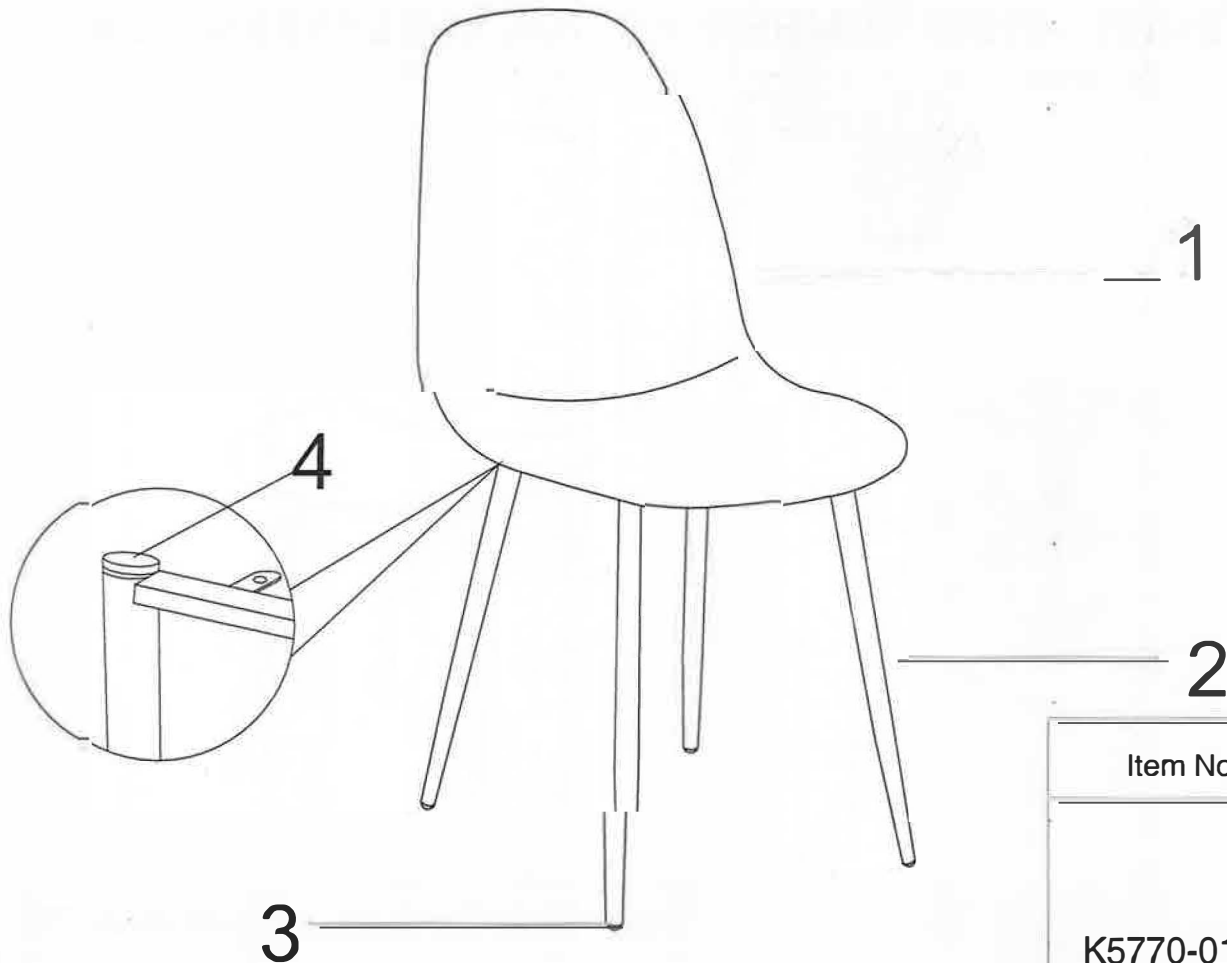

Please Contact us if you are Missing Parts or have any Questions
877-364-8464
info@sunsettrading.com

K5770-01/09&K5338-01/09 HARDWARE			
A	 BLUE	4pcs	M6*16mm
B		4pcs	Ø 6*16mm
C		1pc	5mm ALLEN WRENCH



Item No.			Part Description	Quantity
K5770-01/09 & K5338-01/09	1		Chair back & seat	1pc
	2		Leg Frame	1pc
	3		Glide ϕ 16mm	4pcs
	4		ϕ 25mm	4pcs
	Hardware		Hardware Pack	1pc



Please Contact us if you are Missing
Parts or have any Questions
877-364-8464
info@sunsettrading.com