

ASSEMBLY INSTRUCTIONS

SKU: G5115-01/ G5115-03 /G5115-05

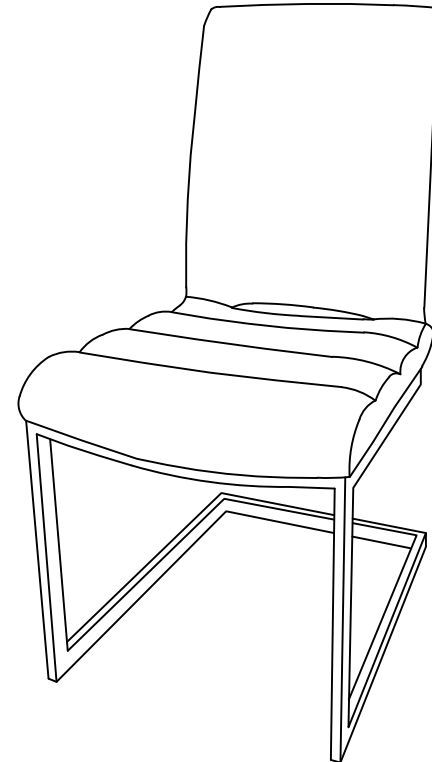
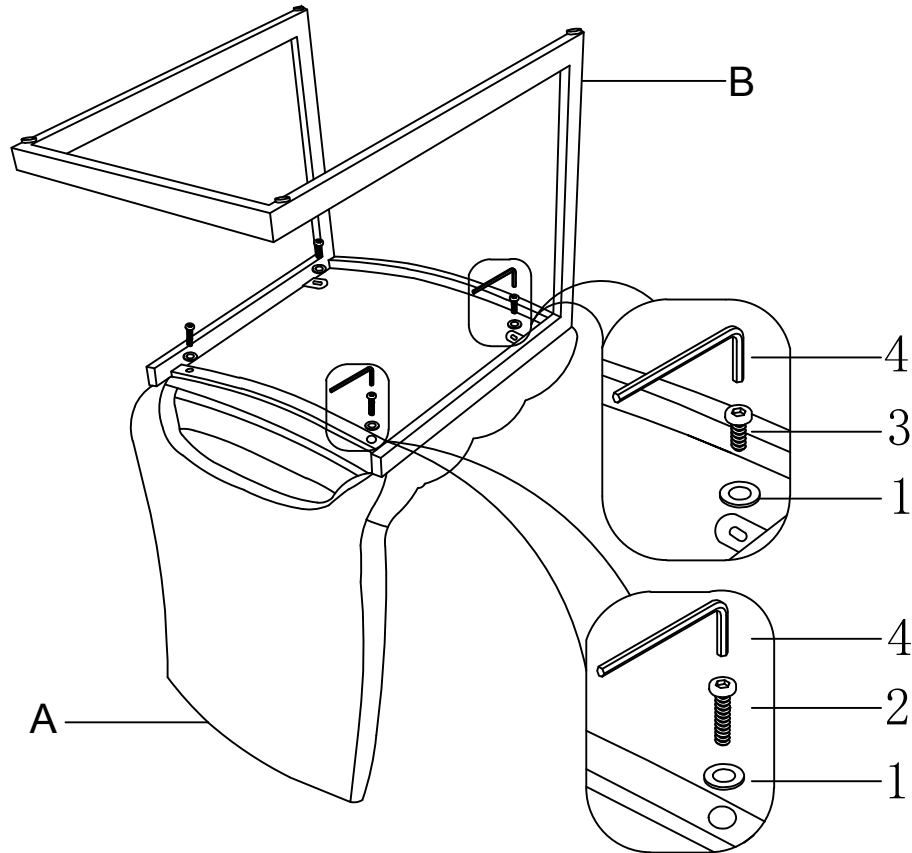

Chair

STEP 1



Note: Please do not tighten all bolts or discard cartons and packaging material until assembly is completed, thank you!

G5115 HARDWARE

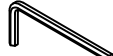
1		4PCS	Φ6*18
2		2PCS	M6*30
3		2PCS	M6*15
4		1PC	M4





Please Contact us if you are Missing
Parts or have any Questions
877-364-8464
info@sunsettrading.com

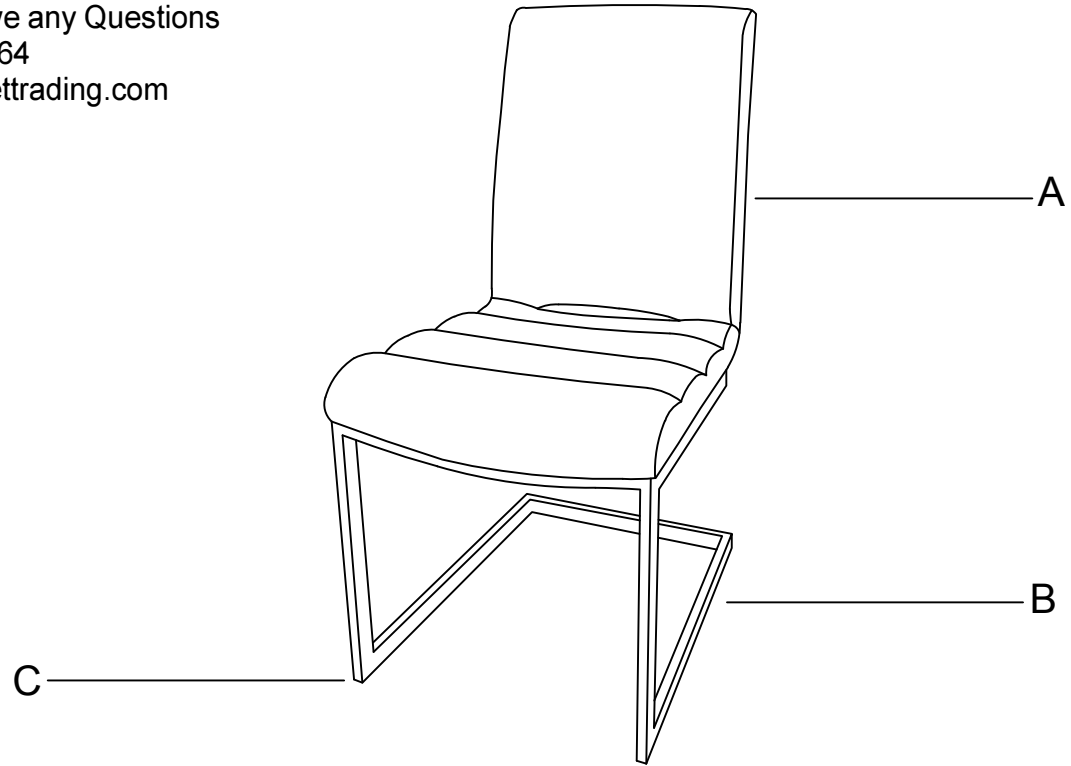

Please Contact us if you are Missing
 Parts or have any Questions
 877-364-8464
 info@sunsettrading.com



		Part Description	Quantity
G5115	A	 Chair Backrest & Seat	1
	B	 Frame	1
	C	 Glide (STEM ϕ 5*7- ϕ 15*13 (H) mm)	4
	HDWR	Hardware pack	1