







Assembly Instruction for BENCH 30062-BENCH

Caution: Please read instructions thoroughly before unpacking assembly parts. Sharp, exposed staple tips can cause injury, therefore, for your protection, please remove any exposed staples used in packing.

1. We recommend that you should assemble this product with the assistance of another person; this will make assembly easier, and will help to eliminate damage to the product or injury to persons during assembly.
2. Be sure to check all packing materials carefully for small parts that may have come loose inside the carton during shipment.
3. Please do not over tighten screws or bolts.
4. Please Put all parts on a non-abrasive floor before assembly, and follow the assembly steps to assemble your newly purchased product correctly and efficiently.

PART LIST			
No.		PART DESC	Q'TY
A		CUSHION WITH FRAME	1
B		LEG	4

HARDWARE LIST			
No.		HARDWARE DESC	Q'TY
1		ALLEN BOLT (1/4"*2")	8
2		FLAT WASHER (1/4"*19*1.5mm)	8
3		SPRING WASHER (1/4")	8
4		ALLEN KEY (M4*68mm)	1

Notice: Estimated assembly time: 3-5min

STEP 1

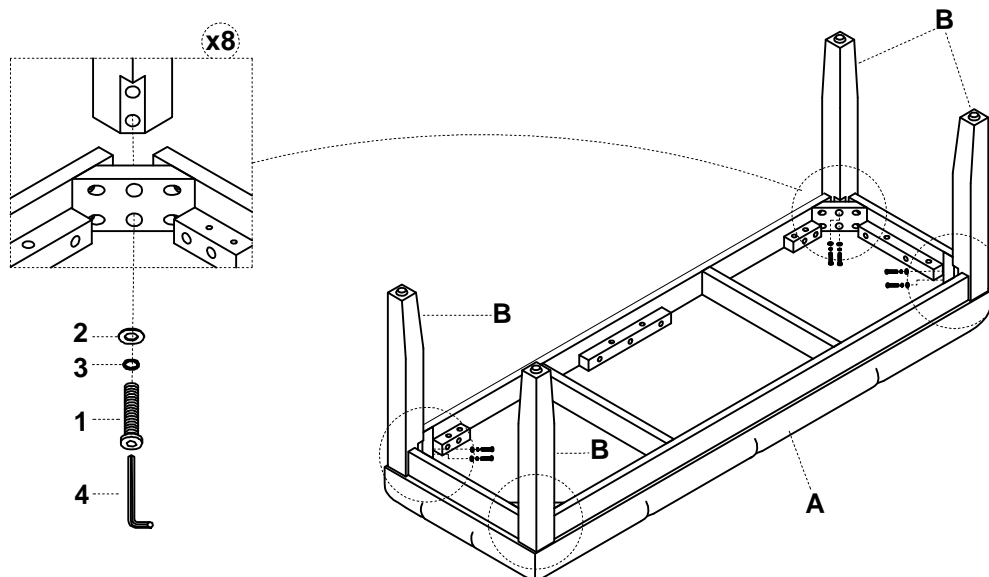

STEP 2: Completed

