

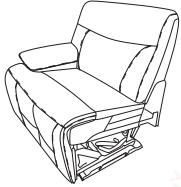













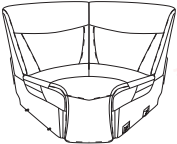







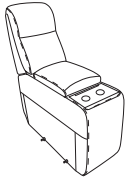



ASSEMBLY INSTRUCTION

Caution: Please read instructions thoroughly before unpacking assembly parts. Sharp, exposed staple tips can cause injury, therefore, for your protection, please remove any exposed staples used in packing.

1. We recommend that you should assemble this product with the assistance of another person; this will make assembly easier, and will help to eliminate damage to the product or injury to persons during assembly.
2. Be sure to check all packing materials carefully for small parts that may have come loose inside the carton during shipment.
3. Please do not over tighten screws or bolts.
4. Please put all parts on a non-abrasive floor before assembly, and follow the assembly steps to assemble your newly purchased product correctly and efficiently.

PART LIST					
MODEL	NO.	PART DESC	SKETCH	CODE	QTY
	A	LAF DP Recliner Body			1
	B	LAF DP Recliner Back			1
	C	Power Supply			1
	D	PWR Armless Recl Body			1
	E	PWR Armless Recl Back			1
	F	Wedge Body			1
	G	Wedge LSF Back			1
	H	Wedge RSF Back			1
	I	Plastic leg			5
	J	Armless Chair Body			1
	K	Armless Chair Back			1
	L	Console Body			1
	M	Console Back			1
	N	Power Supply			1
	O	RAF DP Recliner Body			1
	P	RAF DP Recliner Back			1
	Q	Power Supply			1
	R	Recliner Back			1
	S	Recliner Body			1

 Only tighten all bolts when all bolts aligned with bolt inserts.

ASSEMBLY INSTRUCTION

STEP:1

over the mechanism. Check to assure both sides of the mechanism are positioned inside of the KD receiver on the back frame, pushing in a downward motion from the top of the back frame until a clicking sound is heard. see Fig. 1

STEP:2

POWER SKU'S ONLY: Attach the lead wire from the bottom of each inside back to the lead wire located at the rear of each seat. Care is to be taken to make sure that no wires are in the path of the reclining mechanism. Make sure to close the clip lock to prevent the connection from coming loose

STEP:3

Close the Outside Backs: Using the preattached Velcro on the outside back flap align and press to the preattached velcro attached to the bottom rear of the seat frame.

Note: Follow the same process above on all sku's until all KD Backs are attached

STEP:4

Wedge Only: Carefull to the wedge on its back. Attach the 5 legs (I) to the T nuts, location is pre marked

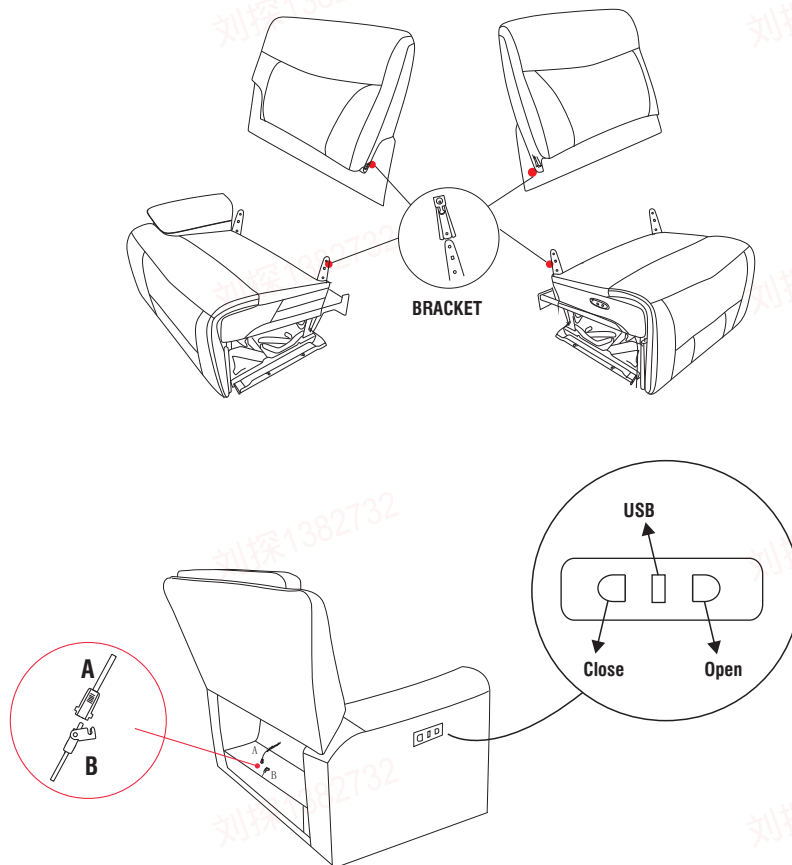

ASSEMBLY INSTRUCTION

STEP:5 Position your product in the area of its intended use and connect together using the sectional connectors

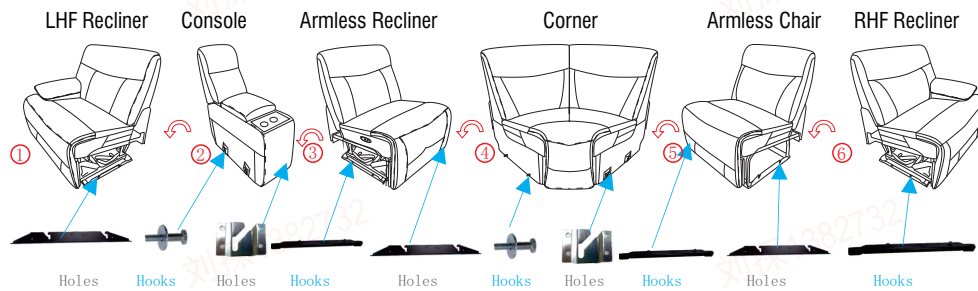

STEP:6 Attach the power cord found at the bottom rear of the armless dual power recliner to the matching plug found at the bottom rear of the LAF/RAF dual power recliner as seen above . Make sure to close the clip lock to prevent the connection from coming loose

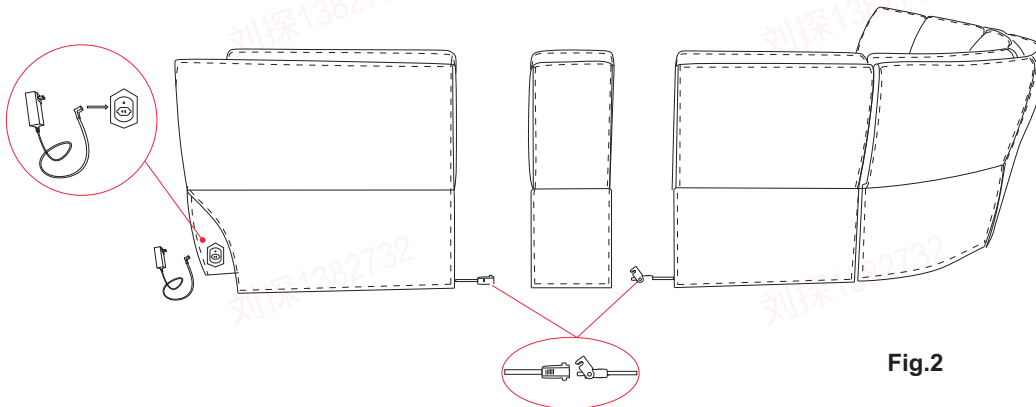

Fig.2

NOTE: The console has a separate power cord located at the bottom rear of the console. Located in the console storage compartment are 2 brushed steel cup holders. Unpackage and place a brushed steel cup holder inside of each plastic cup holder Assembly Complete.

Care & Maintenance

Safety

To avoid any risk of suffocation to animals or children dispose of the plastic bags immediately

Cleaning

As with all surfaces clean with a damp cloth and mild detergent, do not use bleach or abrasive products.

ASSEMBLY INSTRUCTION

STEP:7 Connect the matching end of the power supply to the power switch located at the bottom rear of the arm

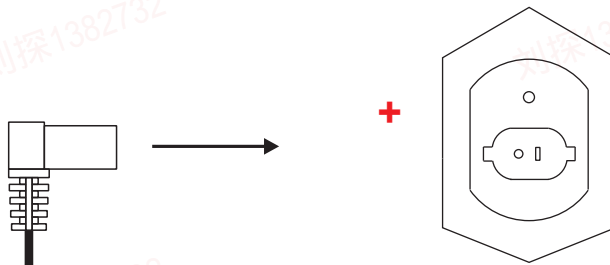

STEP:8 Connecting your power source: To prevent damage or injury, make sure to only plug the power supply into a grounded outlet. A green light should illuminate when your power source has power

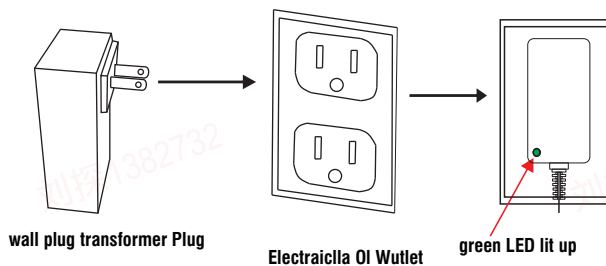

STEP:9 Connecting your power source: To prevent damage or injury, make sure to only plug the power supply into a grounded outlet. A green light should illuminate when your power source has power

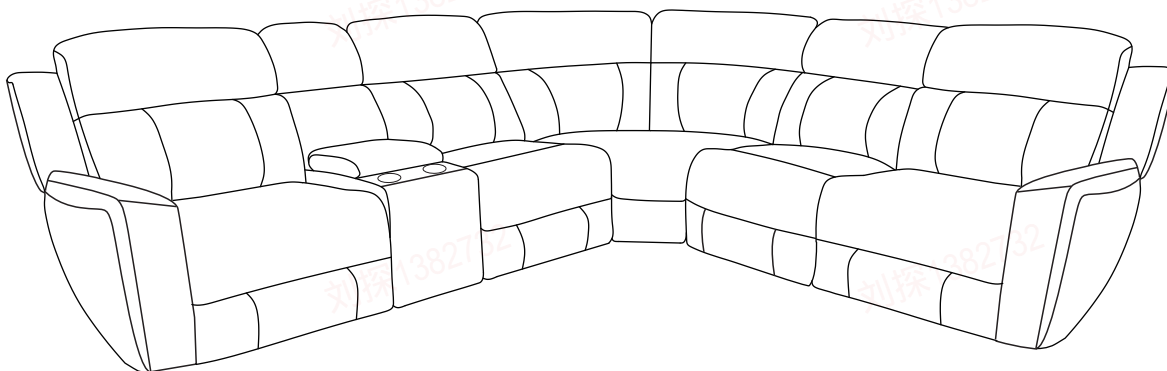
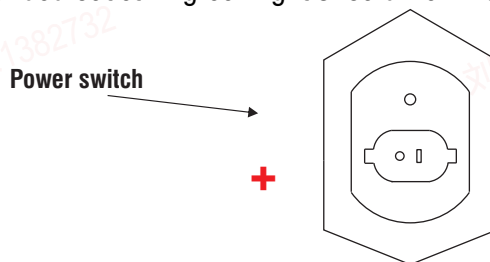

COMPLETED