

ASSEMBLY INSTRUCTIONS

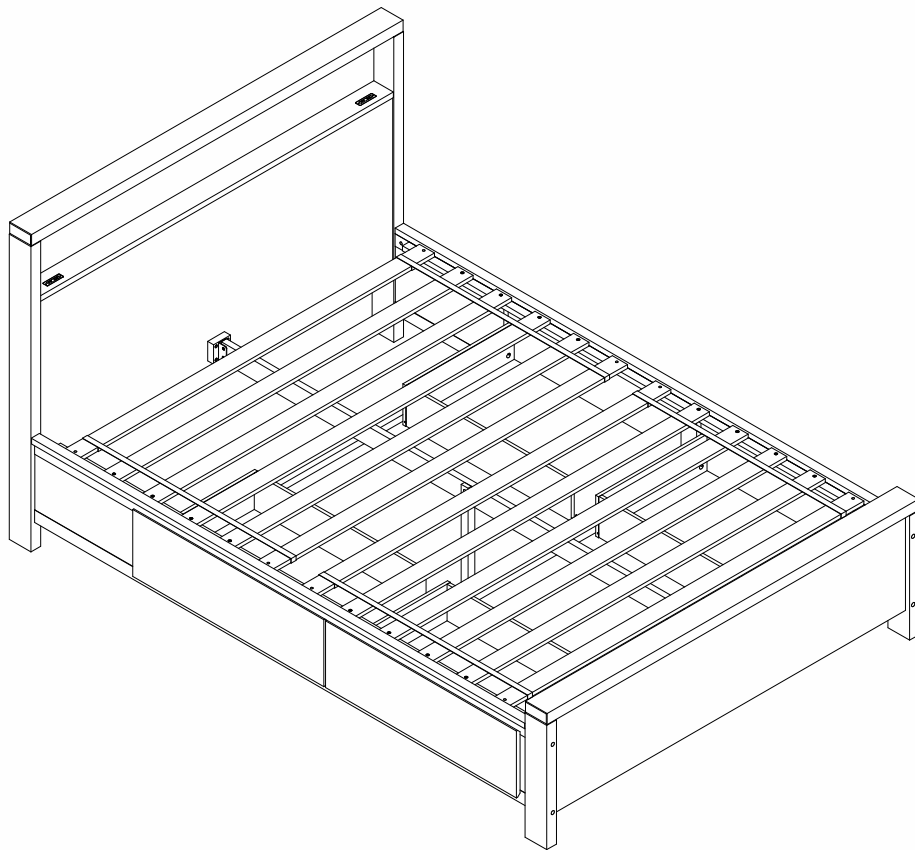

TOOLS REQUIRED



Allen Wrench

(Included)



Phillips
Screwdriver

(Not Included)



2 - People
Recommended

ASSEMBLY RATING



EASY —————> DIFFICULT

The Assembly Rating is a 5-point system showing the level of effort needed to assemble a specific product.



CHECK BEFORE STARTING

Are you missing anything?

Double-check all parts, hardware and accessories listed are all accounted for.

Check out our Quick Tips!

We recommend reviewing the pre-assembly handouts. Even experts need a refresher now and then!

Should we send any replacements?

Are there any irregularities or flaws in the parts? We can send replacements!

Prep Time!

Please review the assembly instructions and all diagrams prior to assembling.

PRE ASSEMBLY INTRODUCTION

We understand building ready-to-assemble furniture can be a challenging experience for some. To help avoid confusion, we have provided some helpful tips that may speed up the process.



Teamwork

ALWAYS have at least two people to help with transporting and assembling the product to avoid potential injury and/or damage.



Suitable Location

Assembling near the area of the intended location is highly recommended.



Sufficient Space

Make sure you have enough space to move around during the assembly.



Avoid Scratches

Use cardboard, blankets or a carpeted area while assembling furniture to prevent to prevent scratches and damages.



Flat Surface

Make sure the furniture rests on a flat and level surface with each leg evenly touching the floor.

ASSEMBLY AND CARE ADVICE



FAILURE TO FOLLOW THE GUIDELINES BELOW MAY RESULT IN INJURY AND/OR PROPERTY DAMAGE.



Position each part correctly and insert screws or bolts into their respective holes.



Turn clockwise to tighten and only tighten when step is completed or when instructed to do so.



Use the appropriate hand tools or power tools for assembly. Select steps, such as tightening screws and/or bolts, may require hand tools to avoid causing damage during assembly.



Save the instructions and store any supplied tools for later maintenance.



After two weeks, check and tighten any loose hardware and repeat again every six months thereafter.

IT IS THE USER'S RESPONSIBILITY TO MAINTAIN THE FURNITURE. THE HARDWARE MAY LOOSEN OVER TIME AND MAY CAUSE THE FURNITURE TO BE WOBBLY AND UNABLE TO SUPPORT ITS INTENDED WEIGHT CAPACITY. THIS MAY LEAD TO COLLAPSE AND MAY CAUSE SERIOUS INJURY.

ASSEMBLY INSTRUCTIONS

"Slat base is using the timber wood material which is LVL (Laminated Veneer Lumber). Laminated Veneer Lumber (LVL) is an engineered wood product that uses multiple layers of thin wood assembled with adhesives, and it is comparable in strength to solid timber slat. Some of the slat you might find the timber wood joiner which is not a crack or defect which is still strong and solid".

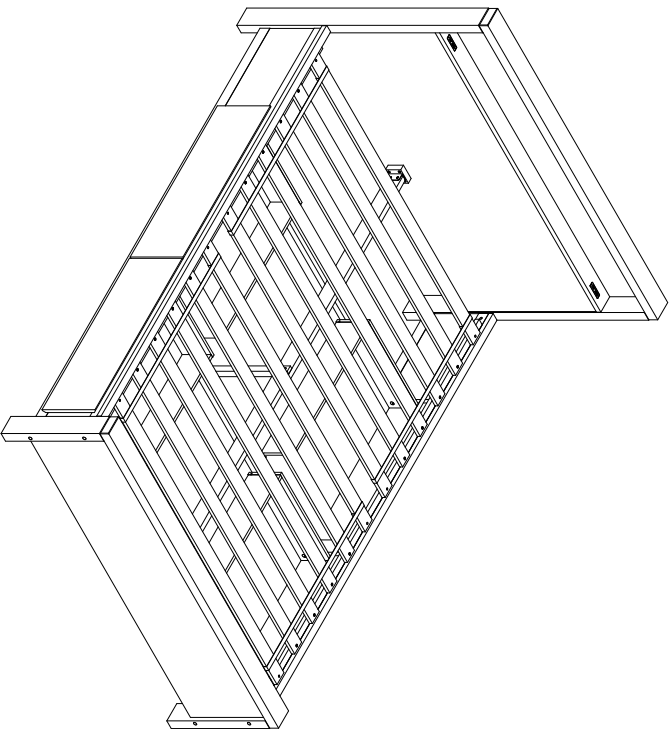

ASSEMBLY TIPS











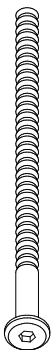

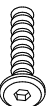
1. Remove hardware from the box and sort by size.
2. Please check to see that all hardware and parts are present prior start of assembly.
3. Please follow attached instructions in the same sequence as numbered to assure fast and easy assembly.

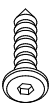



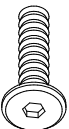
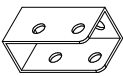
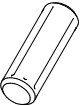



WARNING !

1. Don't attempt to repair or modify parts that are broken or defective. Please contact the store immediately.
2. This product is for home use only and not intended for commercial establishments.

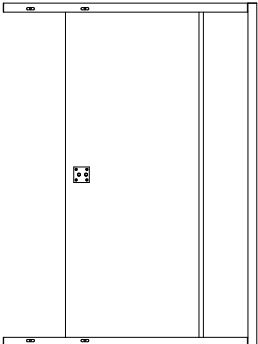
HARDWARE LIST

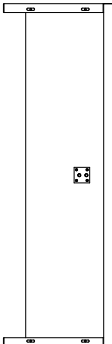
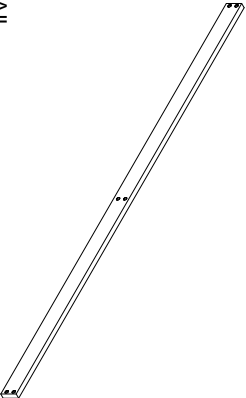
| | | | | | |
|---|--|--------|----|---|--------|
| 1 |  | 8 pcs | 8 |  | 32 pcs |
| 2 | JCBC M6 x 30mm  | 6 pcs | 9 | MINIFIT BOLT  | 24 pcs |
| 3 | JCBC-W M6 x 28mm  | 8 pcs | 10 | MINIFIT CAM  | 24 pcs |
| 4 | JCBB M8 x 20mm  | 8 pcs | 11 | BARREL NUT M6 x 13mm  | 8 pcs |
| 5 | JCBB M8 x 35mm  | 2 pcs | 12 | U-BRACKET  | 2 pcs |
| 6 | WOOD DOWEL Ø10 x 30mm  | 12 pcs | 13 | ALLEN KEY M5  | 1 pc |
| 7 | WOOD DOWEL Ø6 x 30mm  | 32 pcs | 14 | ALLEN KEY M4  | 1 pc |

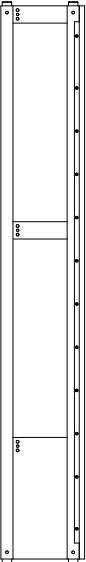
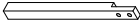
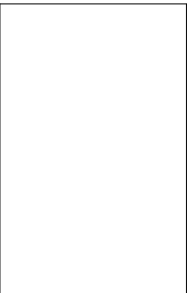
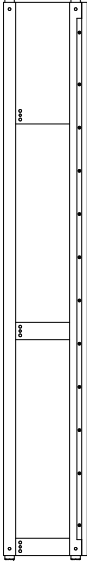
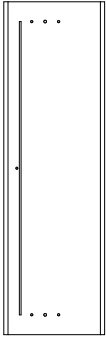
COMPONENT LIST

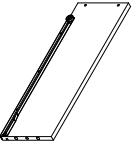
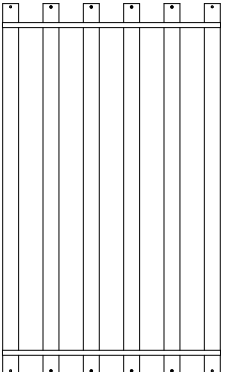
| | | |
|--|---|--|
| <p>A</p> <p>HEADBOARD</p>  <p style="text-align: right;">1 pc</p> | <p>F</p> <p>DRAWER SLIDE SUPPORT RAIL 2</p>  <p style="text-align: right;">1 pc</p> | <p>K</p> <p>DRAWER SIDE PANEL - RIGHT</p>  <p style="text-align: right;">4 pcs</p> |
| <p>B</p> <p>FOOTBOARD</p>  <p style="text-align: right;">1 pc</p> | <p>G</p> <p>CENTER RAIL</p>  <p style="text-align: right;">1 pc</p> | <p>L</p> <p>DRAWER BACK PANEL</p>  <p style="text-align: right;">4 pcs</p> |
| <p>C</p> <p>SIDE PANEL - LEFT</p>  <p style="text-align: right;">1 pc</p> | <p>H</p> <p>SMALL LEG</p>  <p style="text-align: right;">4 pcs</p> | <p>M</p> <p>DRAWER BOTTOM PANEL</p>  <p style="text-align: right;">4 pcs</p> |
| <p>D</p> <p>SIDE PANEL - RIGHT</p>  <p style="text-align: right;">2 pcs</p> | <p>I</p> <p>DRAWER FRONT PANEL</p>  <p style="text-align: right;">4 pcs</p> | <p>N</p> <p>DRAWER SUPPORT</p>  <p style="text-align: right;">4 pcs</p> |
| <p>E</p> <p>DRAWER SLIDE SUPPORT RAIL 1&3</p>  <p style="text-align: right;">2 pcs</p> | <p>J</p> <p>DRAWER SIDE PANEL - LEFT</p>  <p style="text-align: right;">4 pcs</p> | <p>O</p> <p>SLAT</p>  <p style="text-align: right;">2 sets</p> |

STEP 1

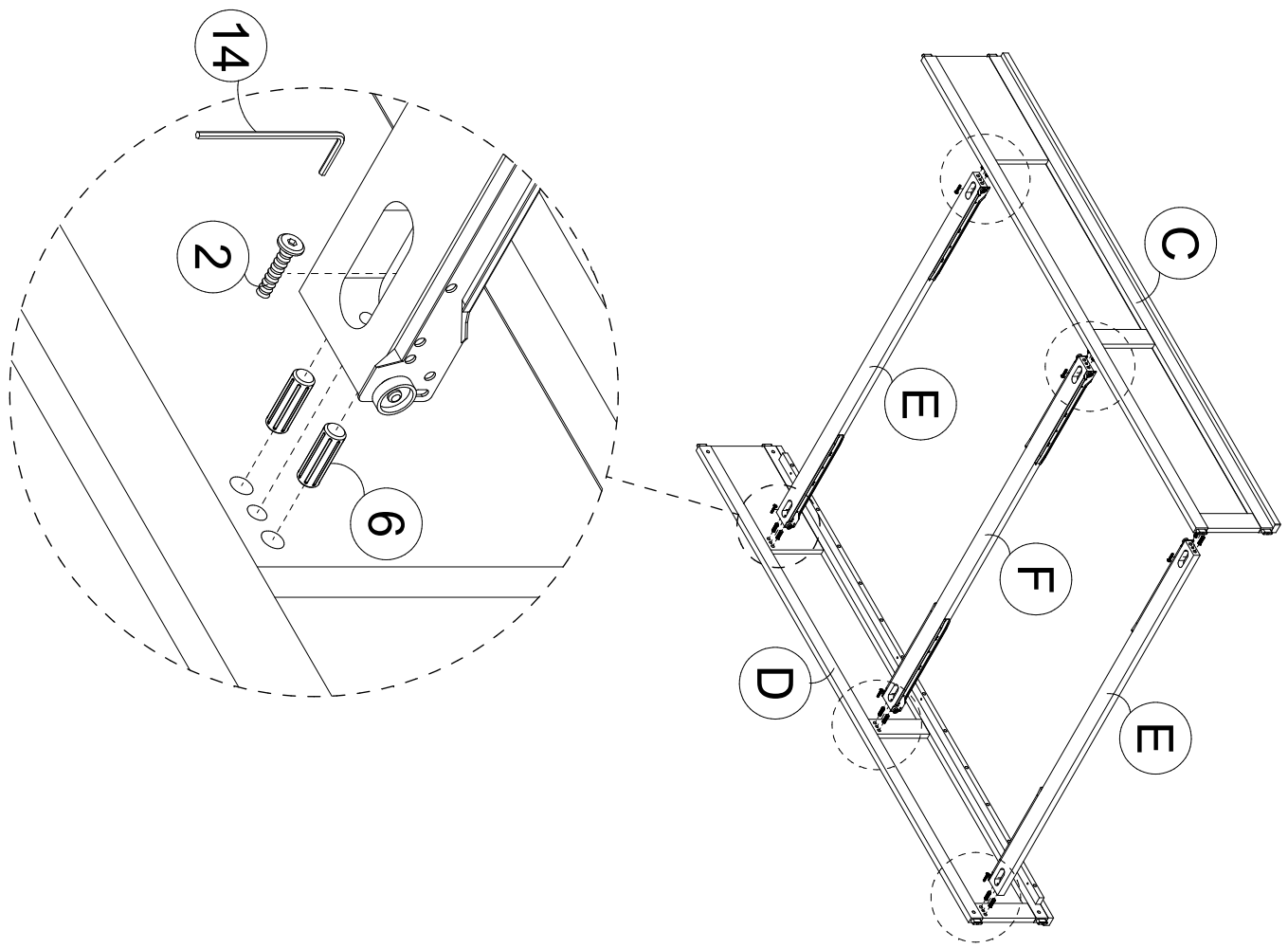

STEP 2

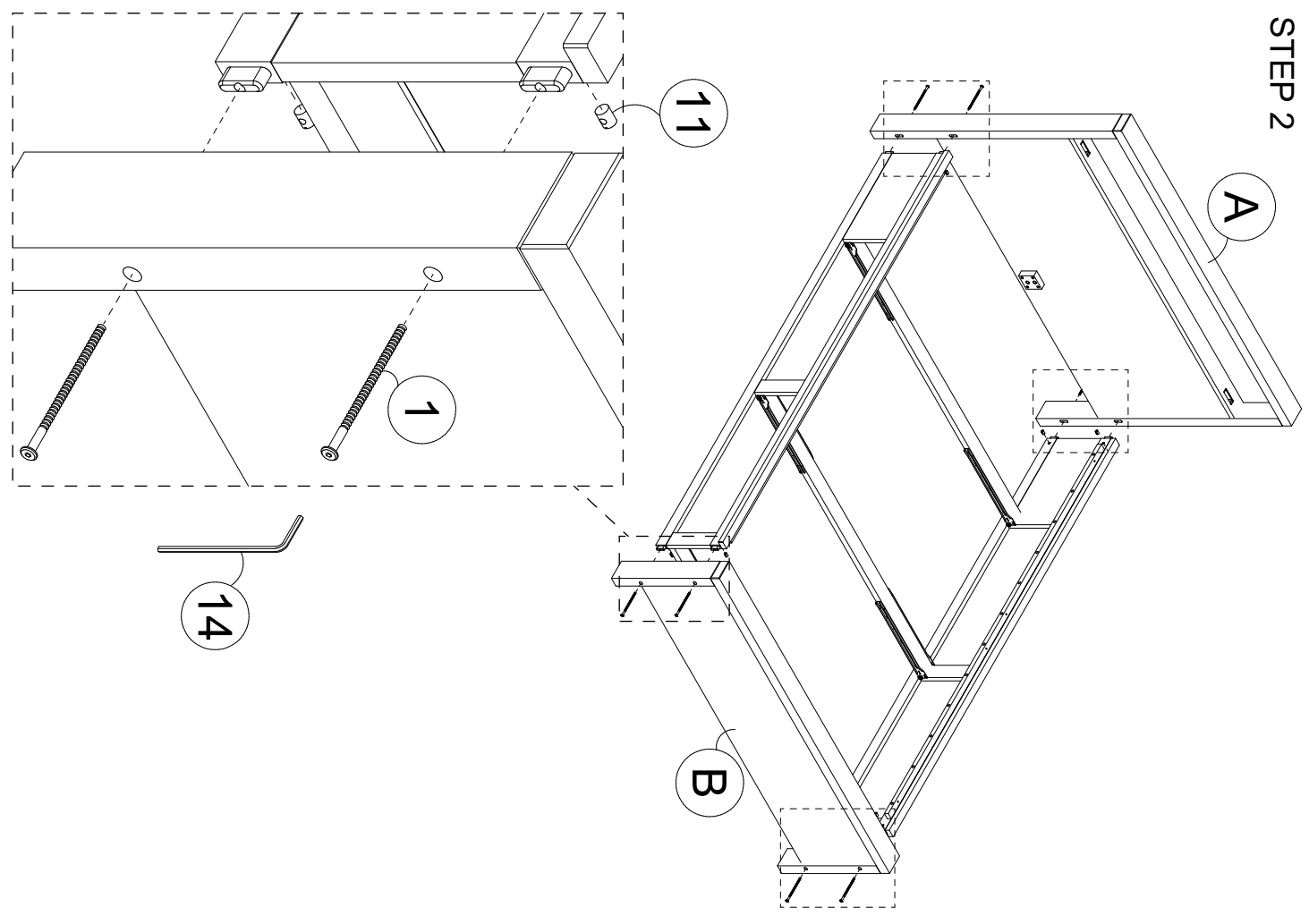

STEP 3

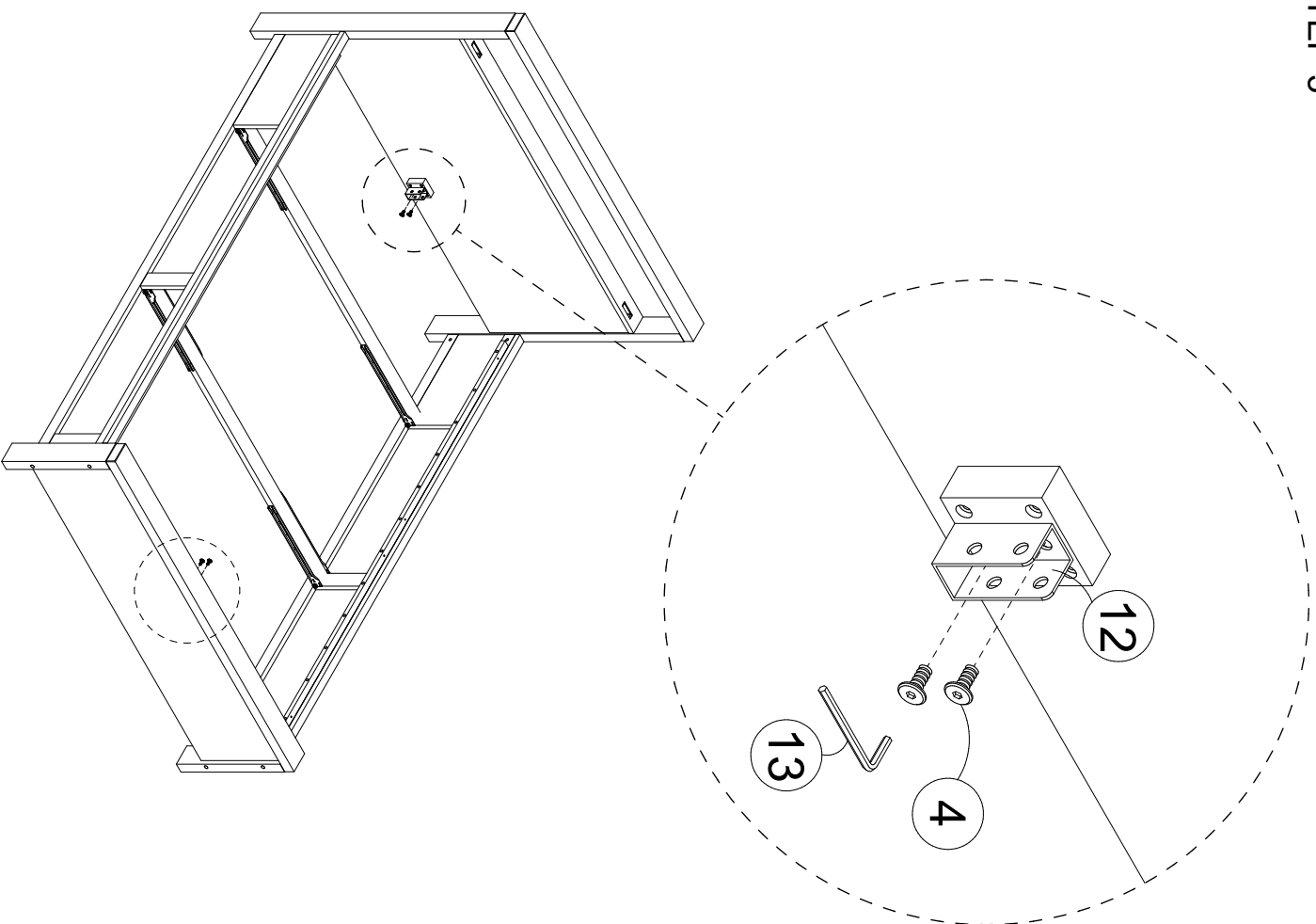

STEP 4

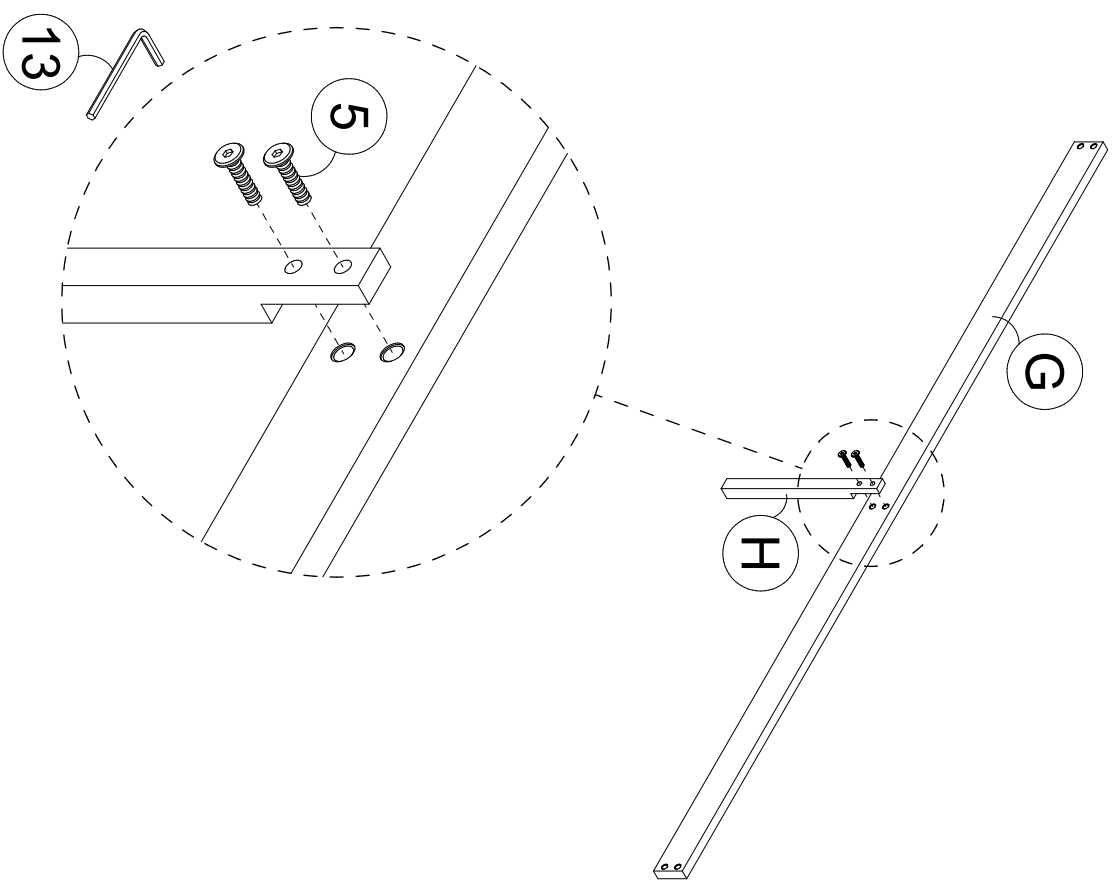

STEP 5

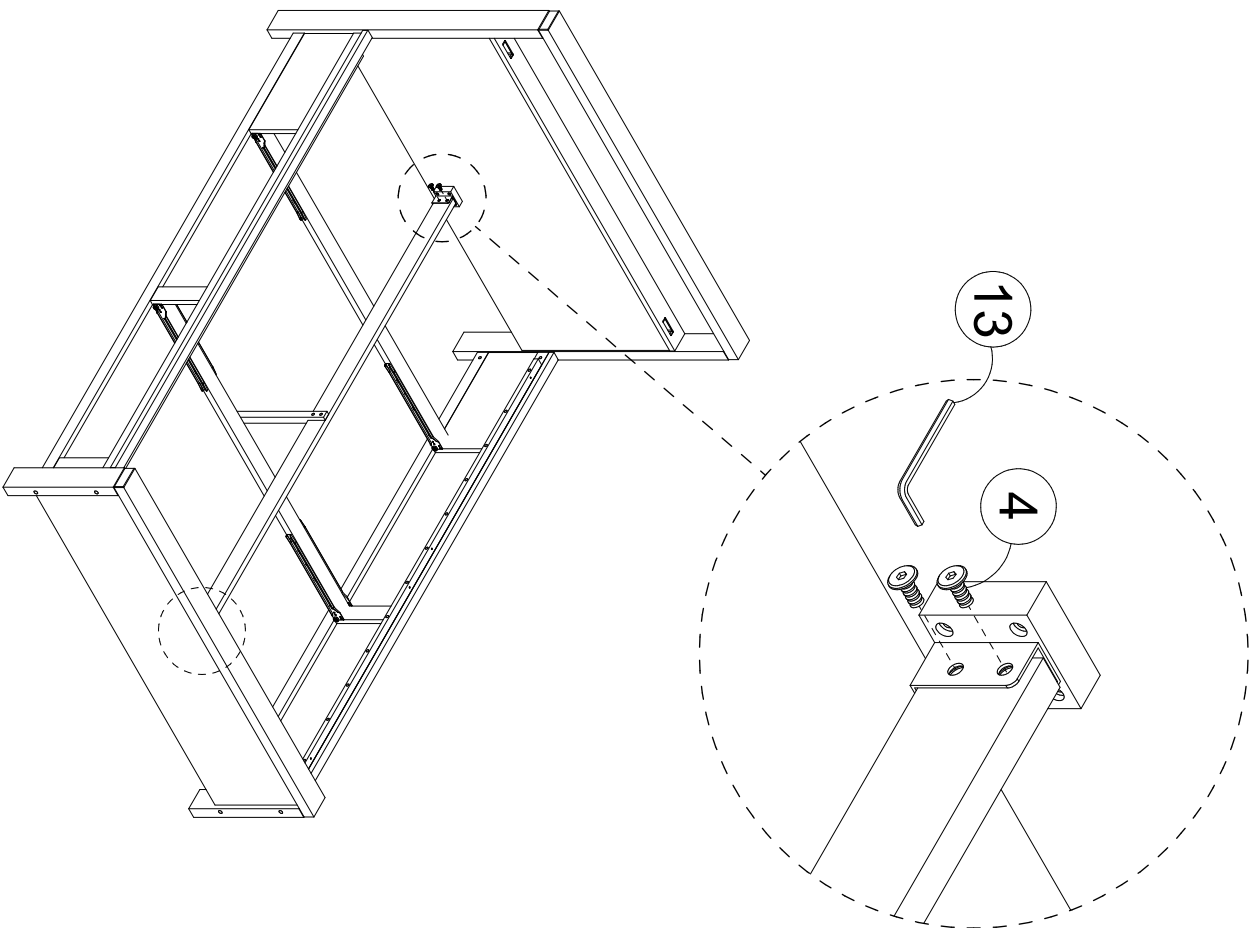

STEP 6

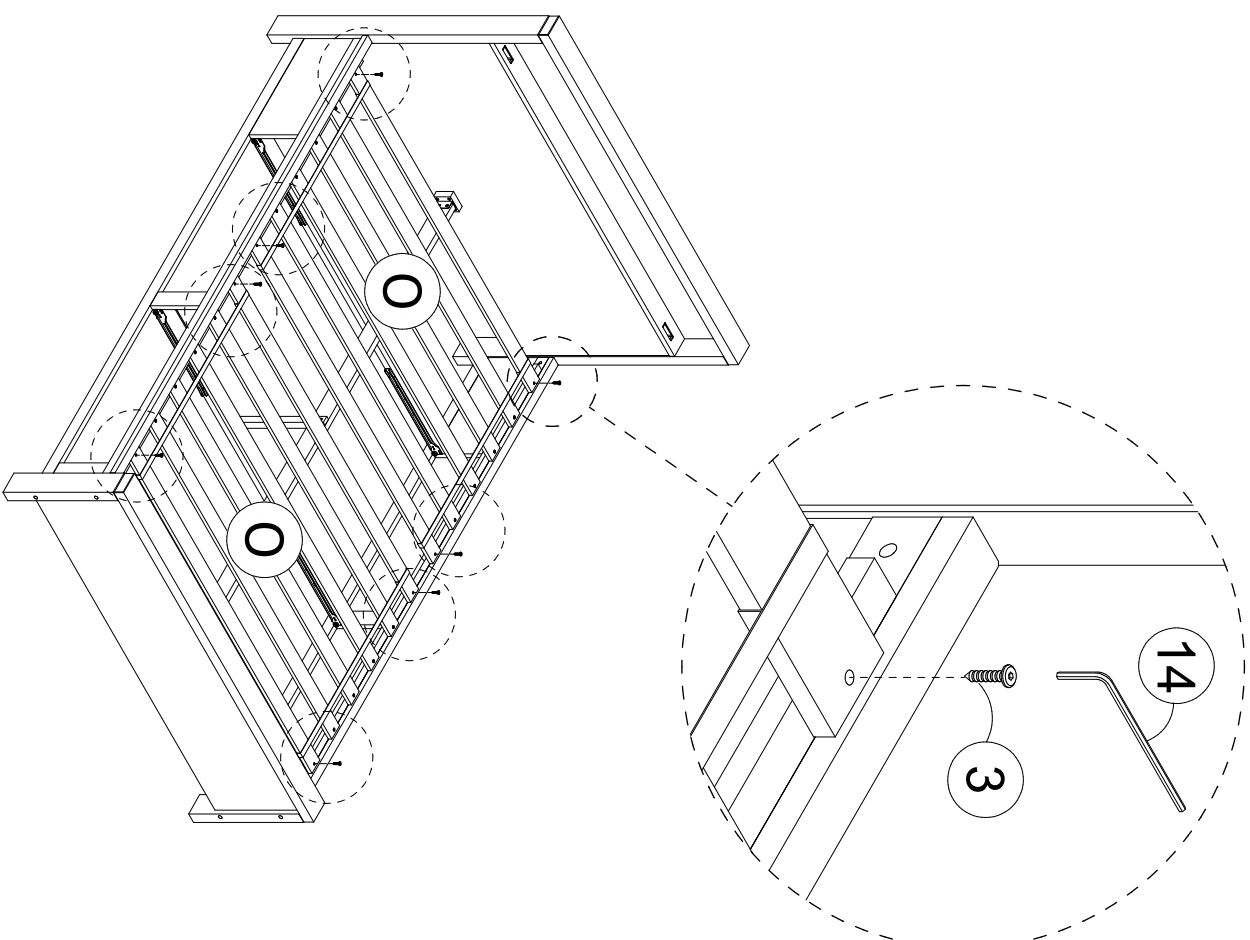

STEP 7

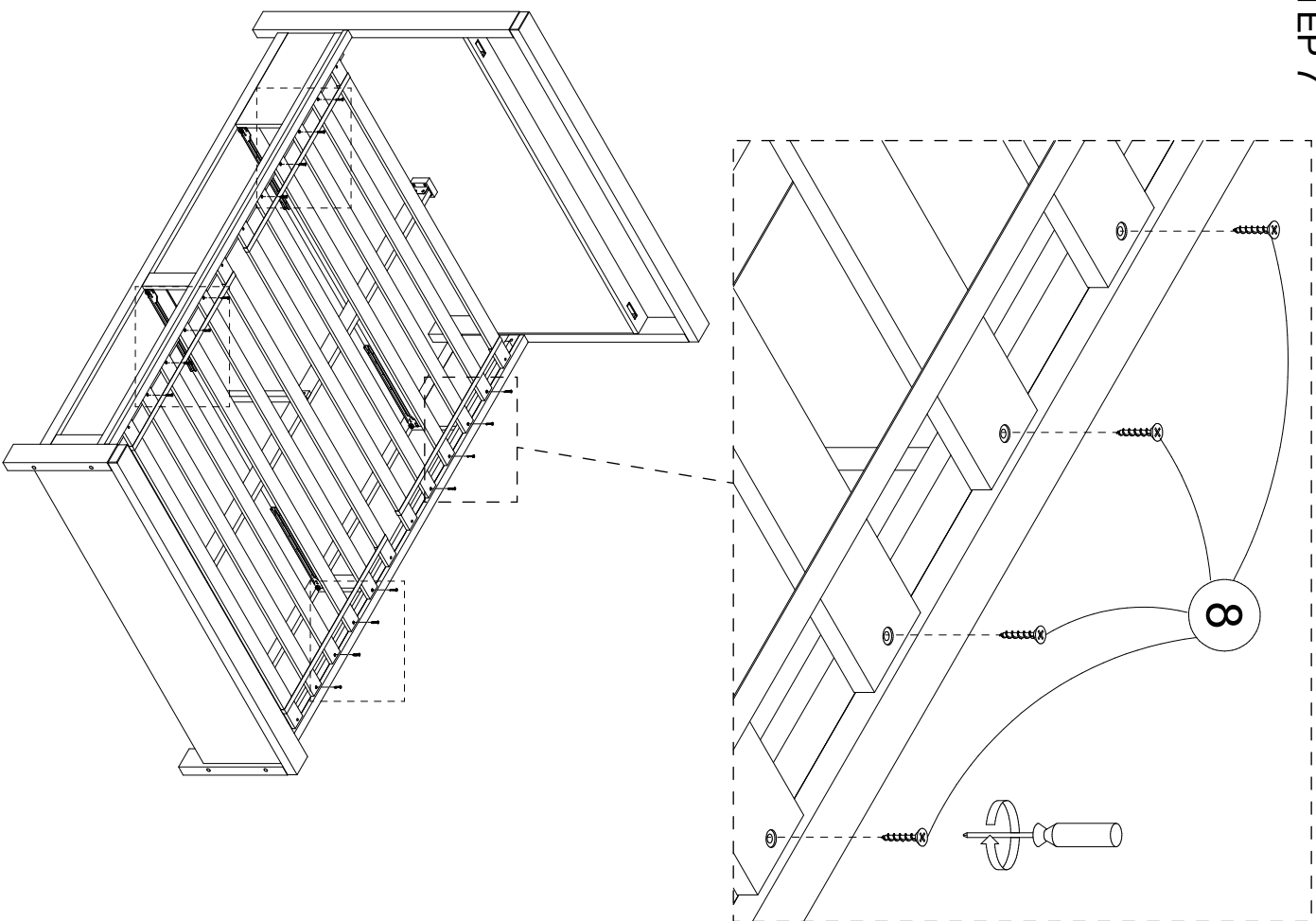

STEP 8

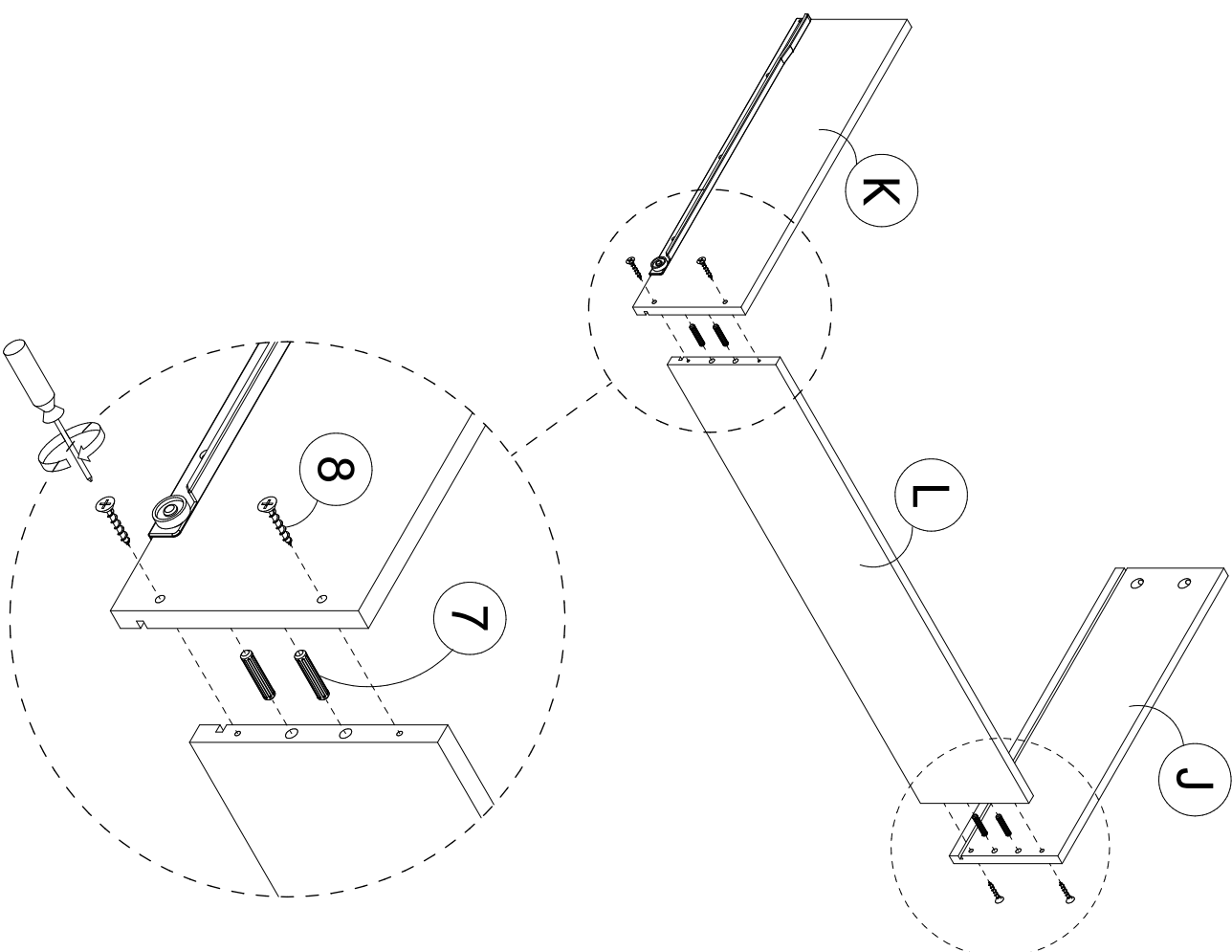

STEP 9

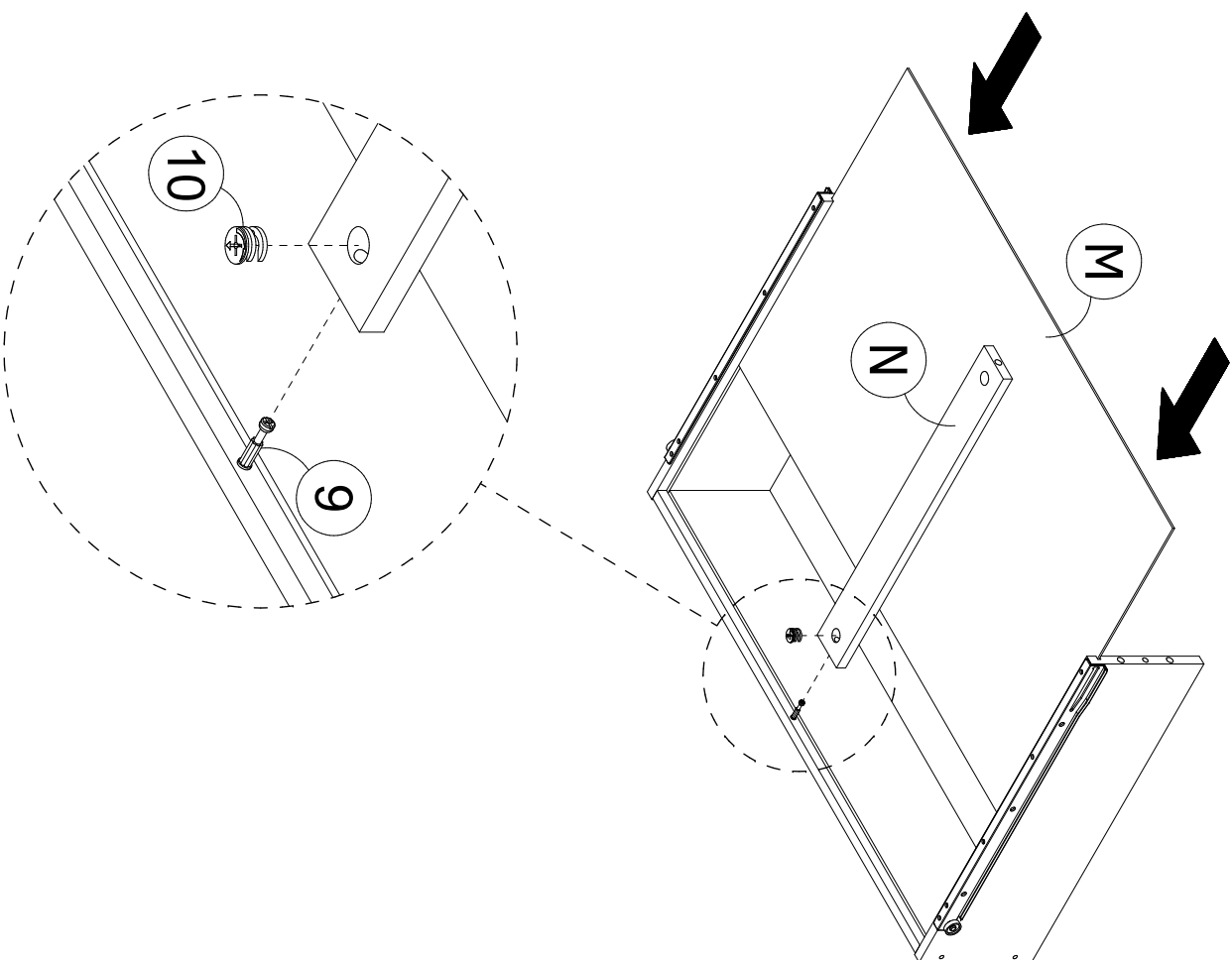

STEP 10

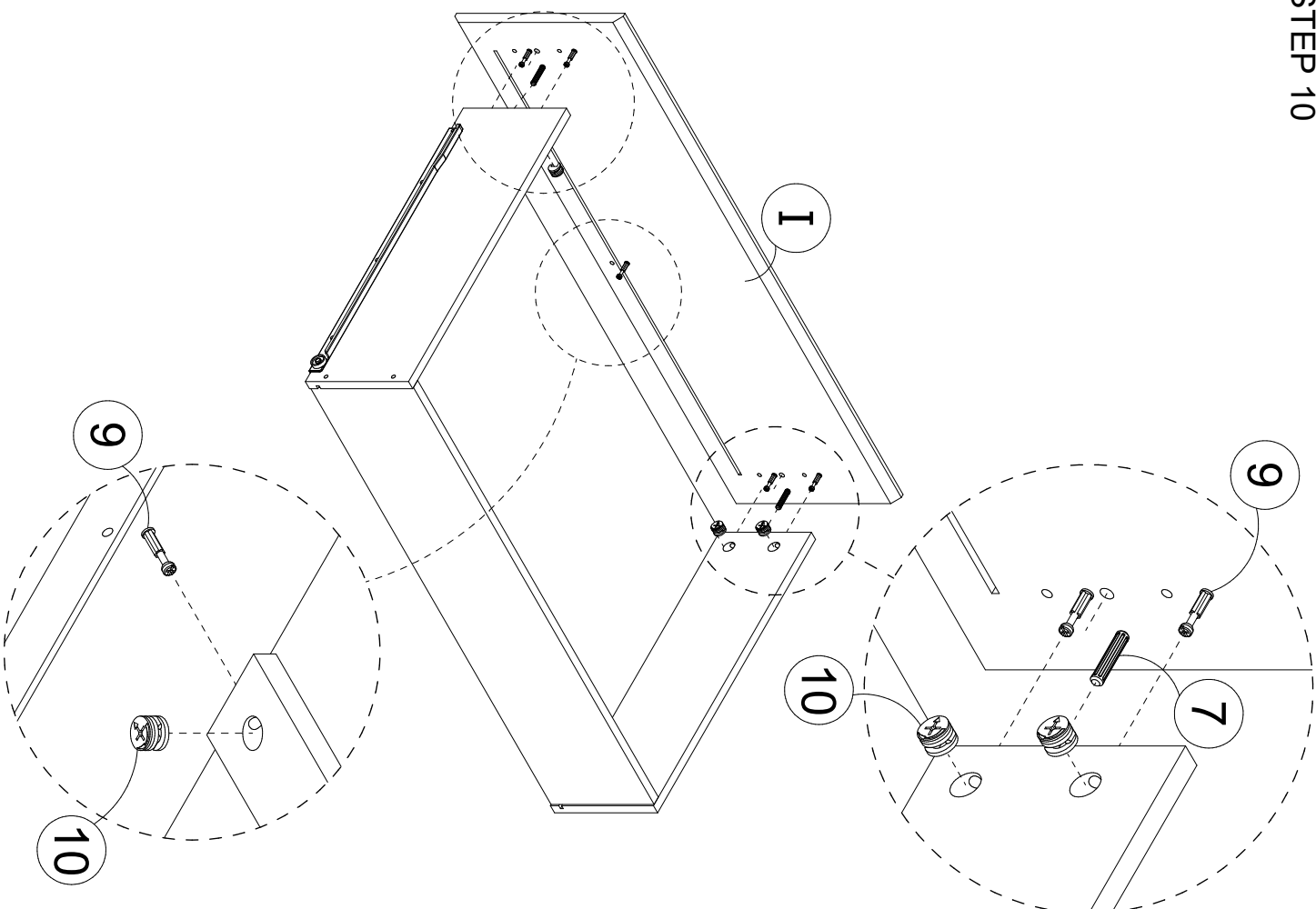

STEP 11

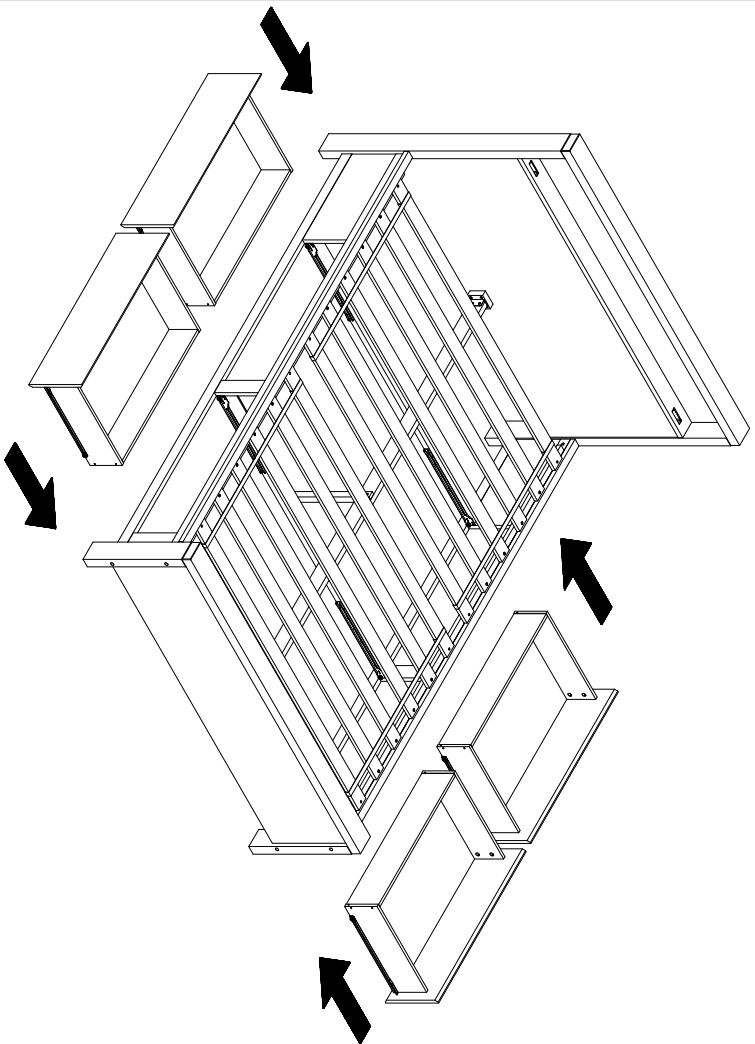

COMPLETE

