

ASSEMBLY INSTRUCTIONS

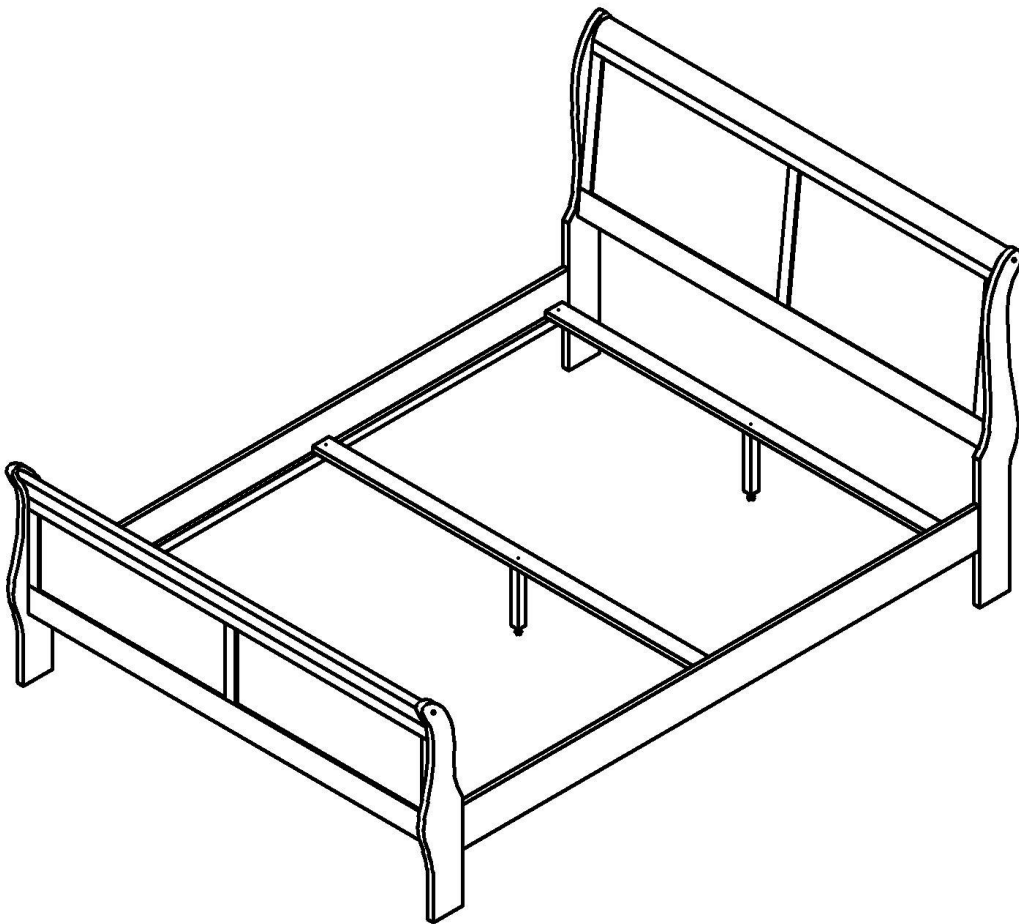

TOOLS REQUIRED



Screwdriver
(Not included)

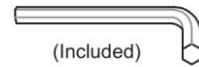

(Included)
Allen Wrench



2 - People

ASSEMBLY RATING



EASY

► D.FFICULT

The Assembly Rating is a 5-point system showing the level of effort needed to assemble a specific product.



CHECK BEFORE STARTING

Are you missing anything?

Double-check all parts, hardware and accessories listed are all accounted for.

Check out our Quick Tips!

We recommend reviewing the pre-assembly handouts. Even experts need a refresher now and then!

Should we send any replacements?

Are there any irregularities or flaws in the parts? We can send replacements!

Prep Time!

Please review the assembly instructions and all diagrams prior to assembling.

PRE ASSEMBLY INTRODUCTION

We understand building ready-to-assemble furniture can be a challenging experience for some. To help avoid confusion, we have provided some helpful tips that may speed up the process.



Teamwork

ALWAYS have at least two people to help with transporting and assembling the product to avoid potential injury and/or damage.

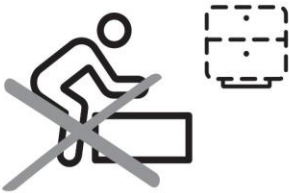

Suitable Location

Assembling near the area of the intended location is highly recommended.



Sufficient Space

Make sure you have enough space to move around during the assembly.



Avoid Scratches

Use cardboard, blankets or a carpeted area while assembling furniture to prevent to prevent scratches and damages.



Flat Surface

Make sure the furniture rests on a flat and level surface with each leg evenly touching the floor.

ASSEMBLY AND CARE ADVICE



FAILURE TO FOLLOW THE GUIDELINES BELOW MAY RESULT IN INJURY AND/OR PROPERTY DAMAGE.



Position each part correctly and insert screws or bolts into their respective holes.



Turn clockwise to tighten and only tighten when step is completed or when instructed to do so.



Use the appropriate hand tools or power tools for assembly. Select steps, such as tightening screws and/or bolts, may require hand tools to avoid causing damage during assembly.



Save the instructions and store any supplied tools for later maintenance.



After two weeks, check and tighten any loose hardware and repeat again every six months thereafter.

IT IS THE USER'S RESPONSIBILITY TO MAINTAIN THE FURNITURE. THE HARDWARE MAY LOOSEN OVER TIME AND MAY CAUSE THE FURNITURE TO BE WOBBLY AND UNABLE TO SUPPORT ITS INTENDED WEIGHT CAPACITY. THIS MAY LEAD TO COLLAPSE AND MAY CAUSE SERIOUS INJURY.

BED



- Please keep instructions for future reference.
- Check the quantity and irregularity of parts and hardware before you start.

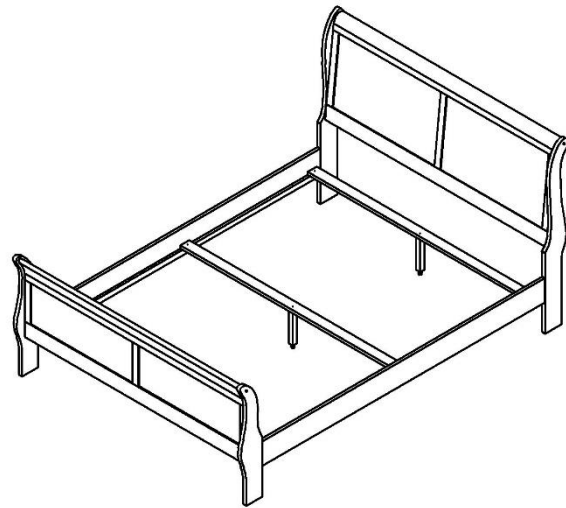

PARTS

① 1pc

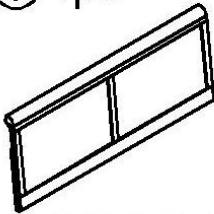

HEADBOARD

② 1pc



HB - LEG LEFT

③ 1pc



HB - LEG RIGHT

④ 1pc

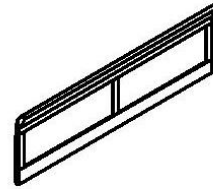

FOOTBOARD

⑤ 1pc



FB - LEG RIGHT

⑥ 1pc



FB - LEG LEFT

⑦ 2pcs

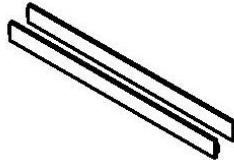

SIDE RAIL

⑧ 3pcs

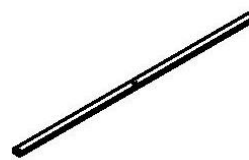

SLAT
1540 x 42 x 17mm

⑨ 3pcs

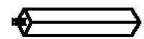

VERTICAL LEG
200 x 29 x 29mm

HARDWARE

HARDWARE INSIDE HEADBOARD / FOOTBOARD

Ⓐ 12pcs



Bolt M6x35mm

Ⓑ 12pcs



Lock Washer

Ⓒ 4pcs



Flat Washer
(Small)

Ⓓ 8pcs



Flat Washer
(Big)

Ⓔ 1pc



Allen Key M4

Ⓕ 4pcs



Wood Button





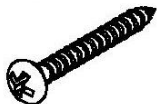







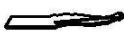

HARDWARE INSIDE SIDE RAIL

Ⓖ 6pcs



Panhead Screw
M4x30mm

packed in 2 cartons

CARTON	DESCRIPTION	PART	HARDWARE
	QUEEN HEADBOARD	①  x1	 A x 12 PCS  B x 12 PCS  C x 4 PCS  D x 8 PCS  E x 1 PC  F x 4 PCS
	QUEEN HB - LEG LEFT	②  x1	
	QUEEN HB - LEG RIGHT	③  x1	
	QUEEN FOOTBOARD	④  x1	
	QUEEN FB - LEG LEFT	⑤  x1	
	QUEEN FB - LEG RIGHT	⑥  x1	
	QUEEN SIDE RAIL	⑦  x2	 G x 6 PCS
	QUEEN SLAT	⑧  x3	
	QUEEN VERTICAL	⑨  x3	

ASSEMBLY INSTRUCTIONS

1

- Part ① 1pc
- Part ② 1pc
- Part ③ 1pc
- Part ④ 1pc
- Part ⑤ 1pc
- Part ⑥ 1pc
- Hardware (A) 8pcs
- Hardware (B) 8pcs
- Hardware (D) 8pcs
- Hardware (E) 1pc

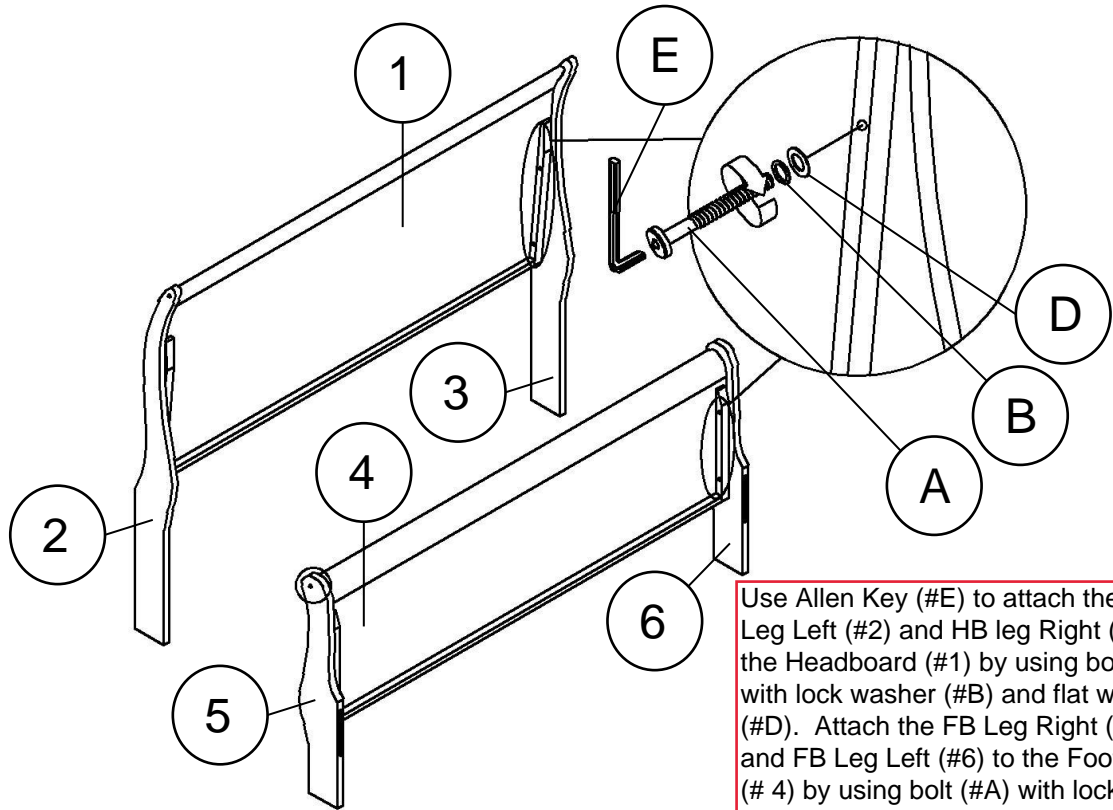

Use Allen Key (#E) to attach the HB Leg Left (#2) and HB leg Right (#3) to the Headboard (#1) by using bolt (#A) with lock washer (#B) and flat washer (#D). Attach the FB Leg Right (#5) and FB Leg Left (#6) to the Footboard (#4) by using bolt (#A) with lock washer (#B) and flat washer (#D).

2

- Hardware (A) 4pcs
- Hardware (B) 4pcs
- Hardware (C) 4pcs
- Hardware (E) 1pc
- Hardware (F) 4pcs

Use Allen key (#E) to tighten bolt (#A) with lock washer (#B) and flat washer (#D) to attach the top of the legs to the headboard (#1). Press in Wood Button (#F) to hide visible bolt.

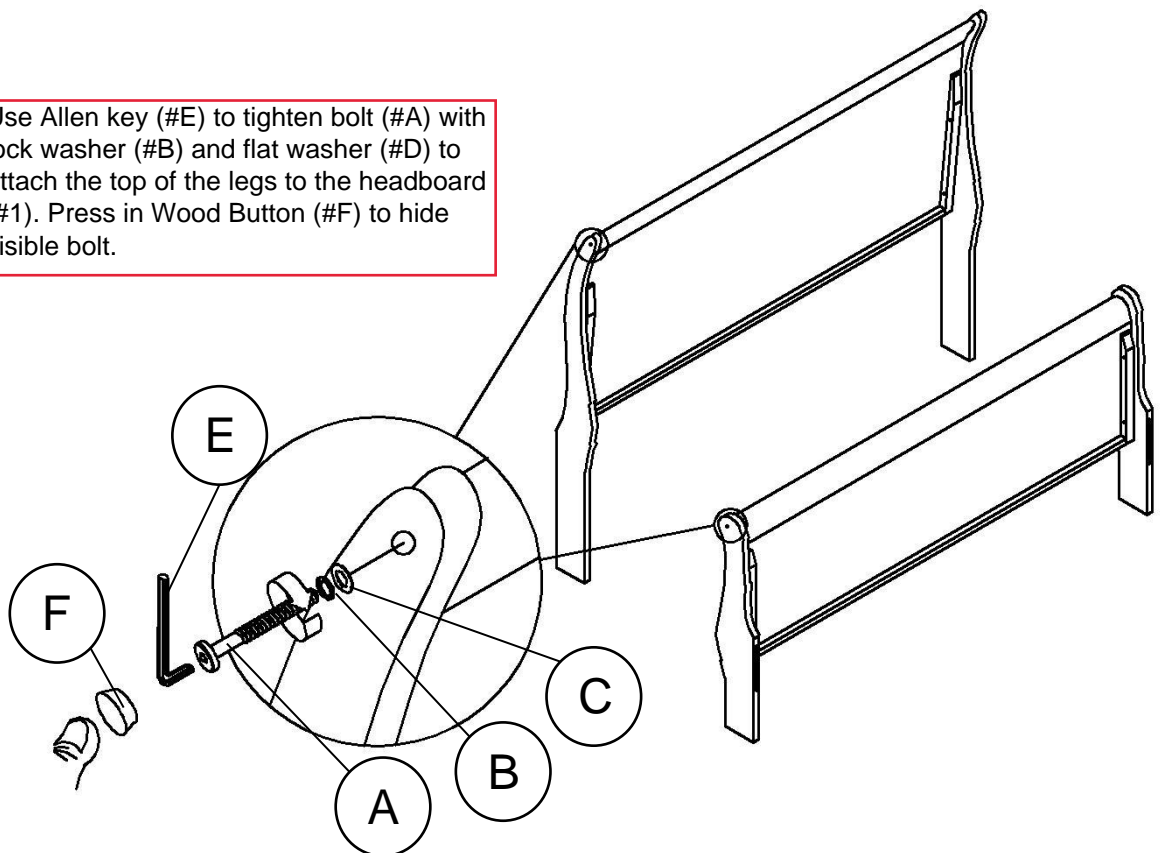

ASSEMBLY INSTRUCTIONS

3

Part 7 2pcs

Hook the ends of Side rail (#7) to the headboard and footboard. Ensure rail is locked in.

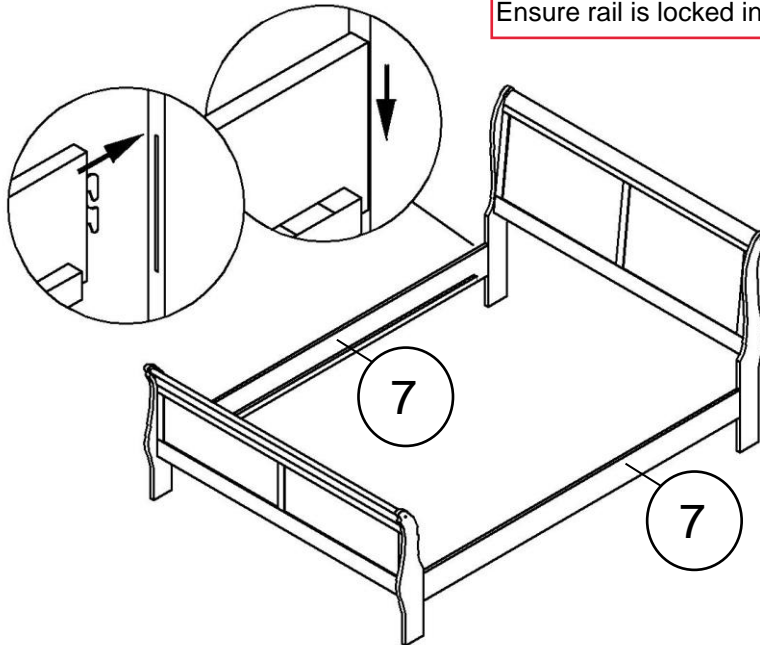

4

Part 8 3pcs
Part 9 3pcs
Hardware G 4pcs

Attach the Vertical leg (#9) to the center of the slat (#8). Then spread slats evenly onto the rails and secure by using Screw (#G). Tighten with screwdriver.

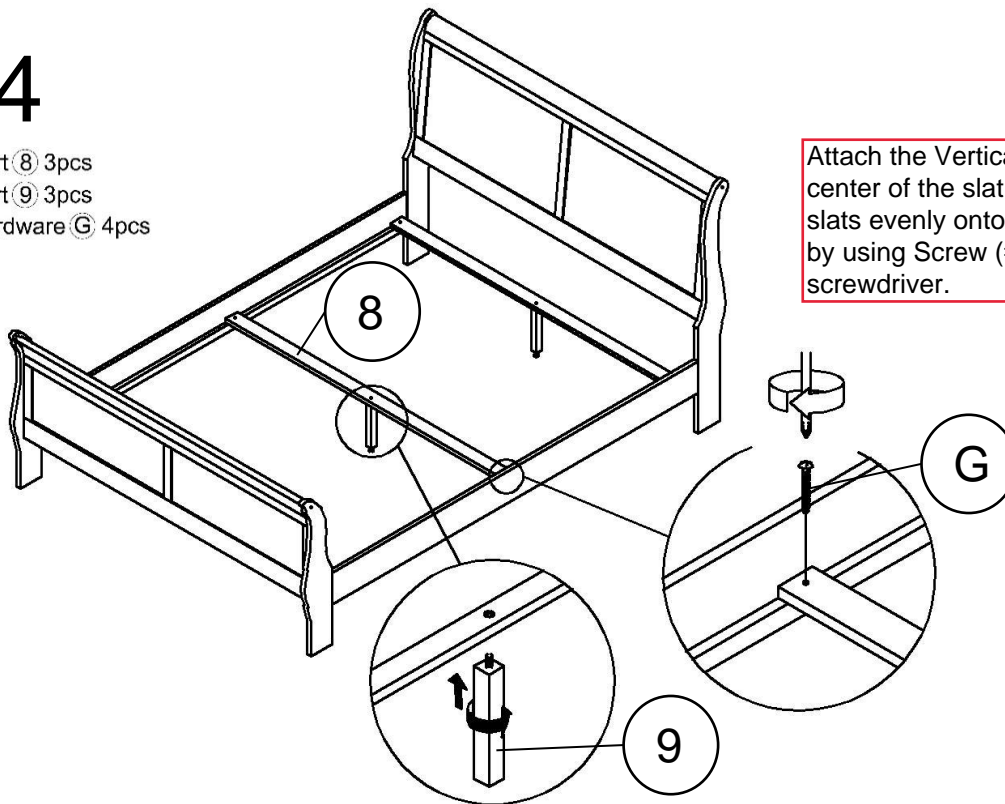

ASSEMBLY COMPLETED



Please ensure the furniture rests on an even and flat surface. If the product wobbles or feels loose, double-check all bolts and/or screws are properly tightened and secured.

Keep this handy!

Please retain this instruction manual and any order-related information for future reference.

Lift, don't drag!

To avoid damage to product please always LIFT the product when transporting or adjusting the placement.

This product is intended for RESIDENTIAL USE ONLY and not commercial use.

ASSEMBLY INSTRUCTIONS

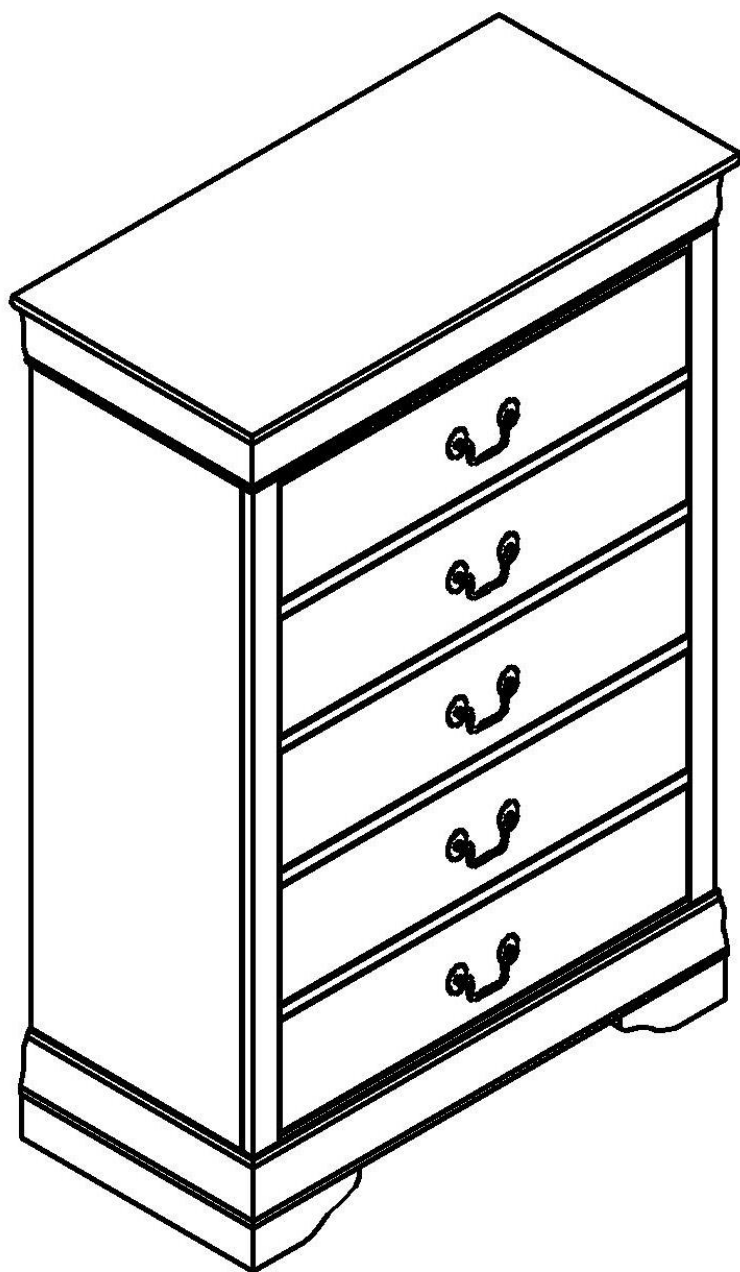

TOOLS REQUIRED



Screwdriver
(Not included)

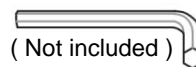

(Not included)

Allen Wrench



2 - People

ASSEMBLY RATING



EASY

► D.FFICULT

The Assembly Rating is a 5-point system showing the level of effort needed to assemble a specific product.



CHECK BEFORE STARTING

Are you missing anything?

Double-check all parts, hardware and accessories listed are all accounted for.

Check out our Quick Tips!

We recommend reviewing the pre-assembly handouts. Even experts need a refresher now and then!

Should we send any replacements?

Are there any irregularities or flaws in the parts? We can send replacements!

Prep Time!

Please review the assembly instructions and all diagrams prior to assembling.

PRE ASSEMBLY INTRODUCTION

We understand building ready-to-assemble furniture can be a challenging experience for some. To help avoid confusion, we have provided some helpful tips that may speed up the process.



Teamwork

ALWAYS have at least two people to help with transporting and assembling the product to avoid potential injury and/or damage.

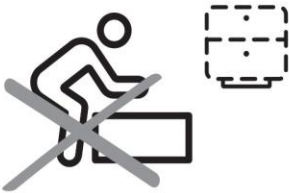

Suitable Location

Assembling near the area of the intended location is highly recommended.



Sufficient Space

Make sure you have enough space to move around during the assembly.



Avoid Scratches

Use cardboard, blankets or a carpeted area while assembling furniture to prevent to prevent scratches and damages.



Flat Surface

Make sure the furniture rests on a flat and level surface with each leg evenly touching the floor.

ASSEMBLY AND CARE ADVICE



FAILURE TO FOLLOW THE GUIDELINES BELOW MAY RESULT IN INJURY AND/OR PROPERTY DAMAGE.



Position each part correctly and insert screws or bolts into their respective holes.



Use the appropriate hand tools or power tools for assembly. Select steps, such as tightening screws and/or bolts, may require hand tools to avoid causing damage during assembly.

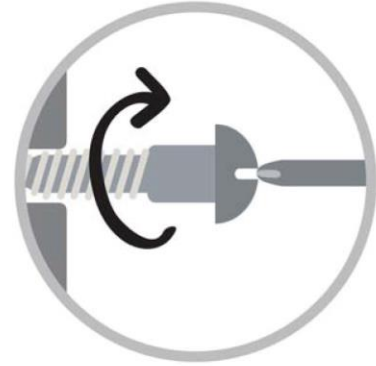

Turn clockwise to tighten and only tighten when step is completed or when instructed to do so.



Save the instructions and store any supplied tools for later maintenance.



After two weeks, check and tighten any loose hardware and repeat again every six months thereafter.

IT IS THE USER'S RESPONSIBILITY TO MAINTAIN THE FURNITURE. THE HARDWARE MAY LOOSEN OVER TIME AND MAY CAUSE THE FURNITURE TO BE WOBBLY AND UNABLE TO SUPPORT ITS INTENDED WEIGHT CAPACITY. THIS MAY LEAD TO COLLAPSE AND MAY CAUSE SERIOUS INJURY.

CHEST



- Please keep instructions for future reference.
- Check the quantity and irregularity of parts and hardware before you start.



PARTS

① 1pc

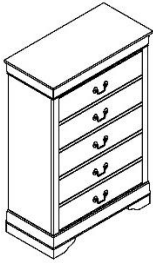

CHEST

HARDWARE

HARDWARE INSIDE CHEST

Ⓐ 1pc



TIP RESTRAINT

ASSEMBLY INSTRUCTIONS

1

Part ① 1pc
Hardware ② 1pc

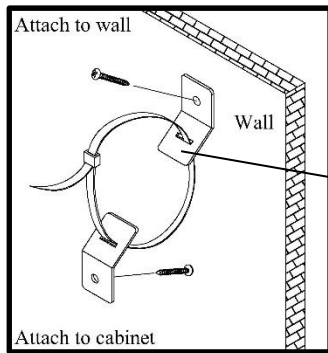

Use the tip resistant kit to mount Back of Chest(#1) to the wall.

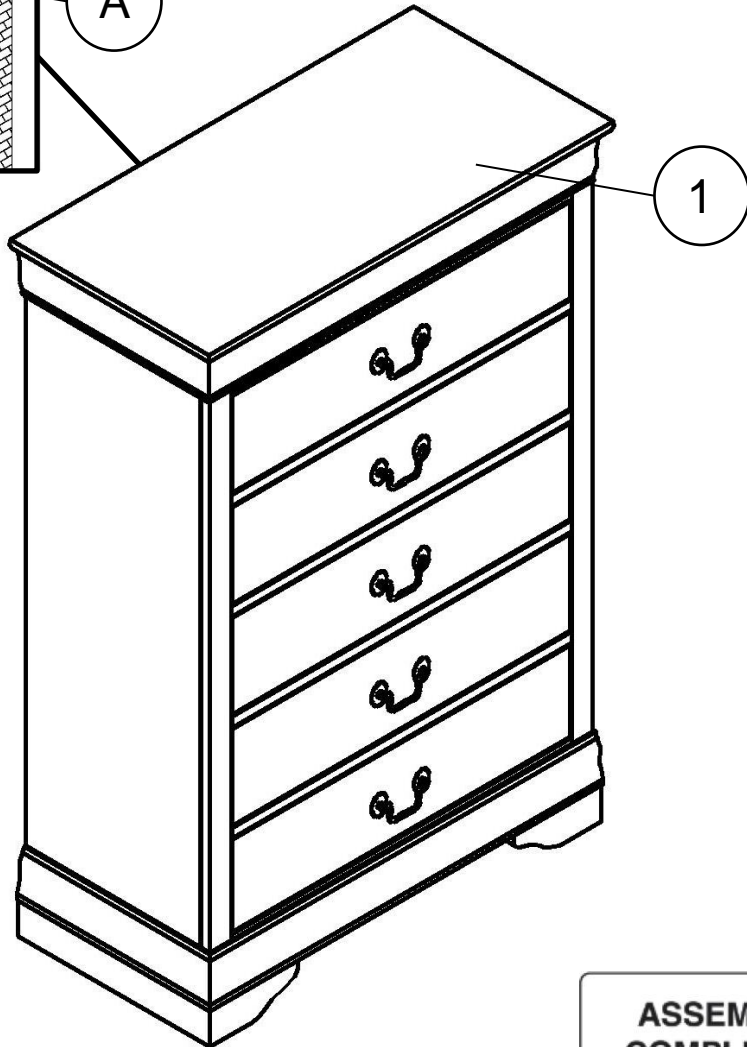

ASSEMBLY COMPLETED



Please ensure the furniture rests on an even and flat surface. If the product wobbles or feels loose, double-check all bolts and/or screws are properly tightened and secured.

✓ Keep this handy!

Please retain this instruction manual and any order-related information for future reference.

✓ Lift, don't drag!

To avoid damage to product please always LIFT the product when transporting or adjusting the placement.

This product is intended for RESIDENTIAL USE ONLY and not commercial use.