

# ASSEMBLY INSTRUCTIONS

---

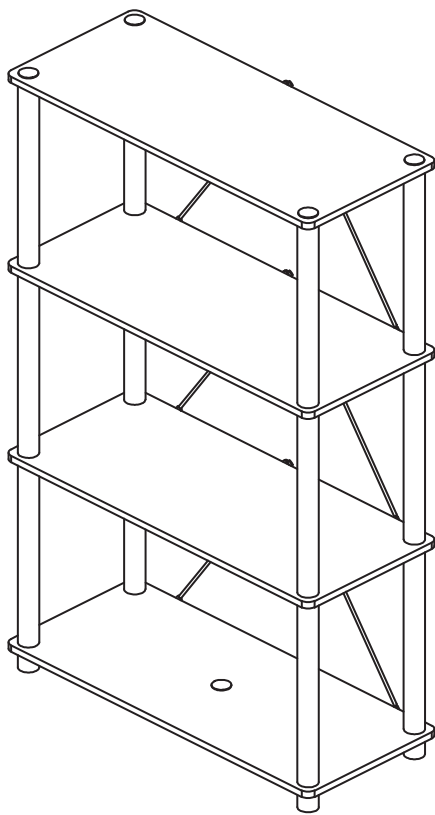

## TOOLS REQUIRED



### Philips Screwdriver

(Not Included)



### Power Tool

(Not Included)



**2 - People  
Recommended**

# DISPLAY SHELF

---

# PRE ASSEMBLY INTRODUCTION

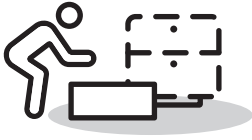

Assemble near the area of the intended location.



Make sure you have enough space to move around.



Use cardboard or blankets to prevent scratches.



Ensure the furniture rests on a flat and level surface.

# ASSEMBLY AND CARE ADVICE



FAILURE TO FOLLOW THE GUIDELINES BELOW MAY RESULT IN INJURY AND/OR PROPERTY DAMAGE.



Position each part correctly and insert screws or bolts into their respective holes.

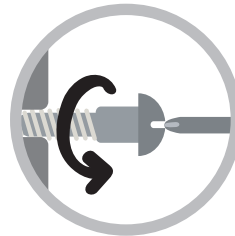

Turn clockwise to tighten and only tighten when step is completed or when instructed to do so.



Use the appropriate hand tools or power tools for assembly.

Select steps, such as tightening screws and/or bolts, may require hand tools to avoid causing damage during assembly.

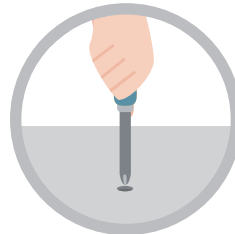

After two weeks, check and tighten any loose hardware and repeat again every six months thereafter.

## **WARNING:**

>This unit has been designed to support the maximum loads shown. Exceeding these load limits could cause sagging, instability, product collapse, and/or serious injury.

>DO NOT allow children to climb on unit.

>Put heavier items on lower shelves.

# ASSEMBLY INSTRUCTIONS

## PARTS

**A** 1PC

**B** 3PCS

**C** 12PCS

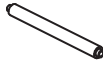
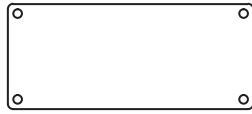
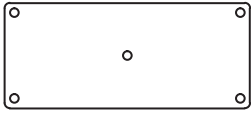

## HARDWARE

**①** 5PCS

**②** 5PCS

**③** 6PCS



**④** 9PCS

**⑤** 1SET



1

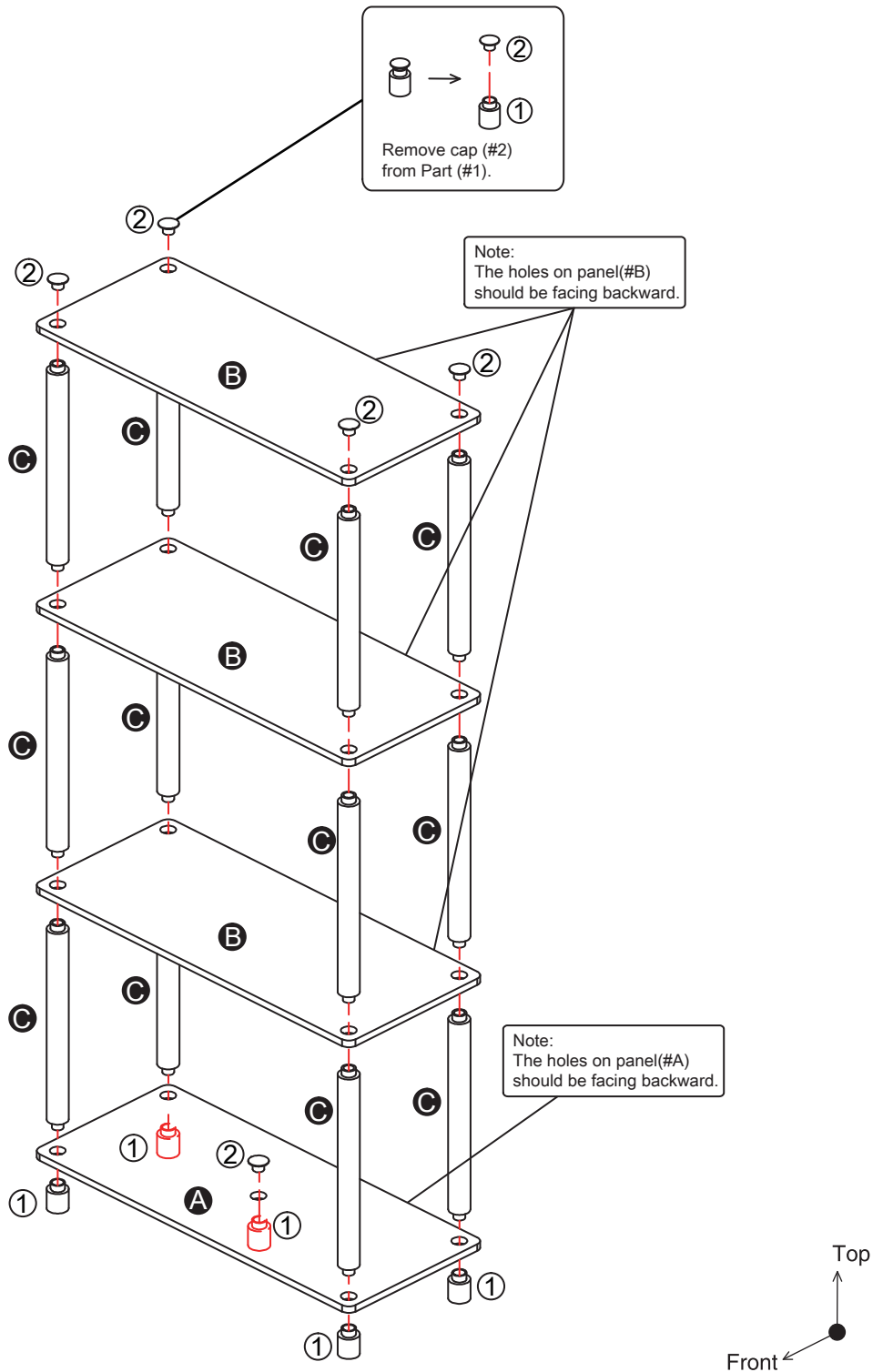

# ASSEMBLY INSTRUCTIONS

2

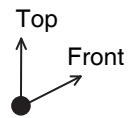
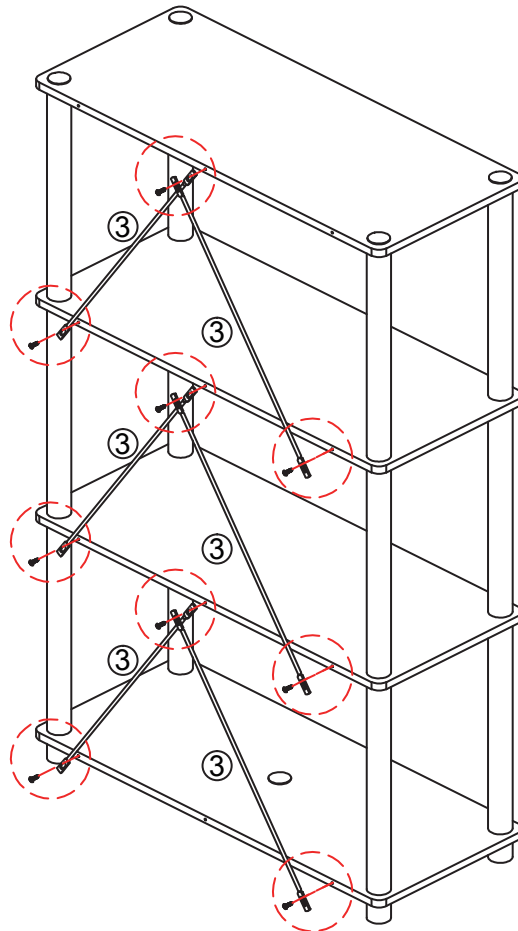
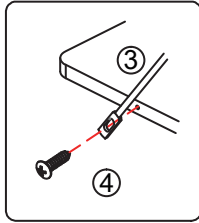
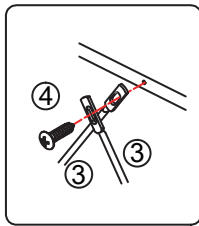

3

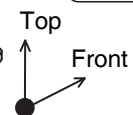
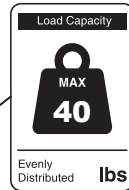
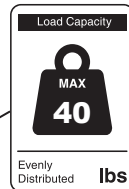
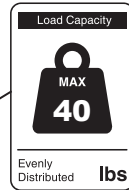
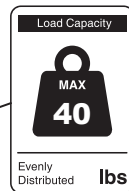
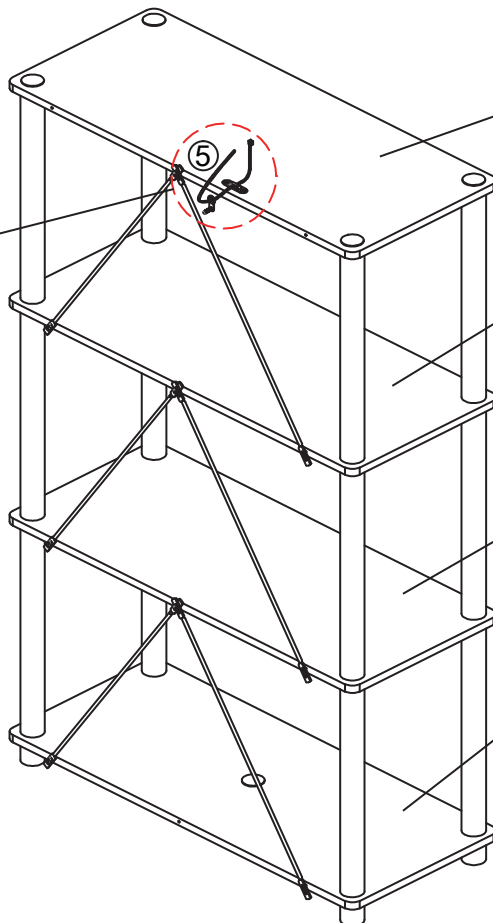
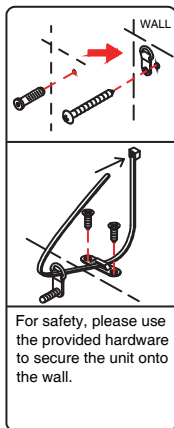

**ASSEMBLY COMPLETED**