

ASSEMBLY INSTRUCTIONS

TOOLS REQUIRED



Phillips
Screwdriver

(Not Included)



2 - Persons
Recommended

ASSEMBLY RATING



EASY —————> DIFFICULT

The Assembly Rating is a 5-point system showing the level of effort needed to assemble a specific product.



CHECK BEFORE STARTING

Are you missing anything?

Double-check all parts, hardware and accessories listed on Page 6 are accounted for.

Should we send any replacements?

Are there any irregularities or flaws in the parts? We can send replacements!

Check out our Quick Tips!

We recommend reviewing the pre-assembly handouts. Even experts need a refresher now and then!

Prep Time!

Please review the assembly instructions and all diagrams prior to assembling. Arrange parts as recommended on Page 7 and group identical hardware together to make assembling easier.

PRE ASSEMBLY INTRODUCTION

We understand building ready-to-assemble furniture can be a challenging experience for some. To help avoid confusion, we have provided some helpful tips that may speed up the process.

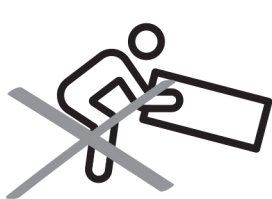

Teamwork

ALWAYS have at least two people to help with transporting and assembling the product to avoid potential injury and/or damage.



Suitable Location

Assembling near the area of the intended location is highly recommended.



Sufficient Space

Make sure you have enough space to move around during the assembly.

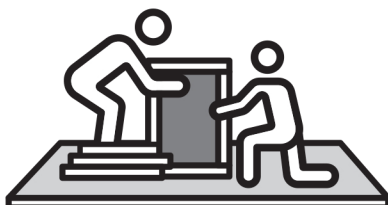

Avoid Scratches

Use cardboard, blankets or a carpeted area while assembling furniture to prevent scratches.

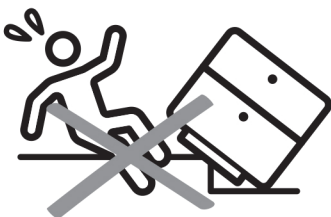

Flat Surface

Make sure the furniture rests on a flat and level surface with each leg evenly touching the floor.

ASSEMBLY AND CARE ADVICE



FAILURE TO FOLLOW THE GUIDELINES BELOW MAY RESULT IN INJURY AND/OR PROPERTY DAMAGE.



Position each part correctly and insert screws or bolts into their respective holes.

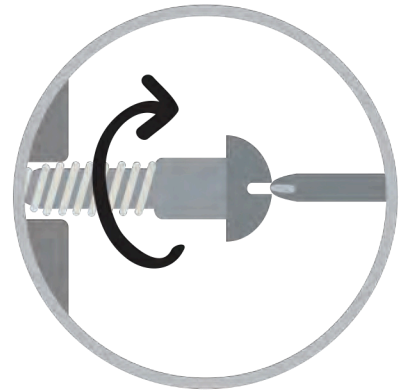

Turn clockwise to tighten and only tighten when step is completed or when instructed to do so.



Use the appropriate hand tools or power tools for assembly. Select steps, such as tightening screws and/or bolts, may require hand tools to avoid causing damage during assembly.



Save the instructions and store any supplied tools for later maintenance.

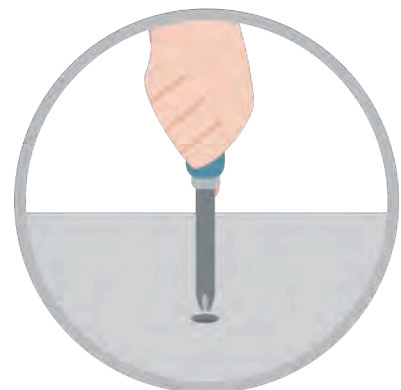

After two weeks, check and tighten any loose hardware and repeat again every six months thereafter.

IT IS THE USER'S RESPONSIBILITY TO MAINTAIN THE FURNITURE. THE HARDWARE MAY LOOSEN OVER TIME AND MAY CAUSE THE FURNITURE TO BE WOBBLY AND UNABLE TO SUPPORT ITS INTENDED WEIGHT CAPACITY. THIS MAY LEAD TO COLLAPSE AND MAY CAUSE SERIOUS INJURY.

SOFA



- Please keep instructions for future reference.
- Check the quantity and irregularity of parts and hardware before you start.

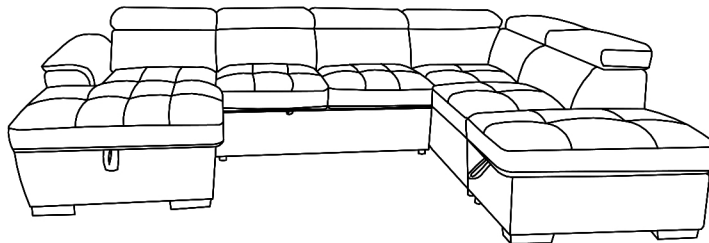

PARTS

#1 1pc



Loveseat

#2 1pc



Left Chaise

#3 1pc



Right Chaise

#4 1pc



Ottoman

#5 6pcs



Headrest

HARDWARE

#A 3pcs

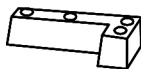

Leg A

#B 2pcs

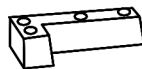

Leg B

#C 8pcs



Leg C

#D 28pcs







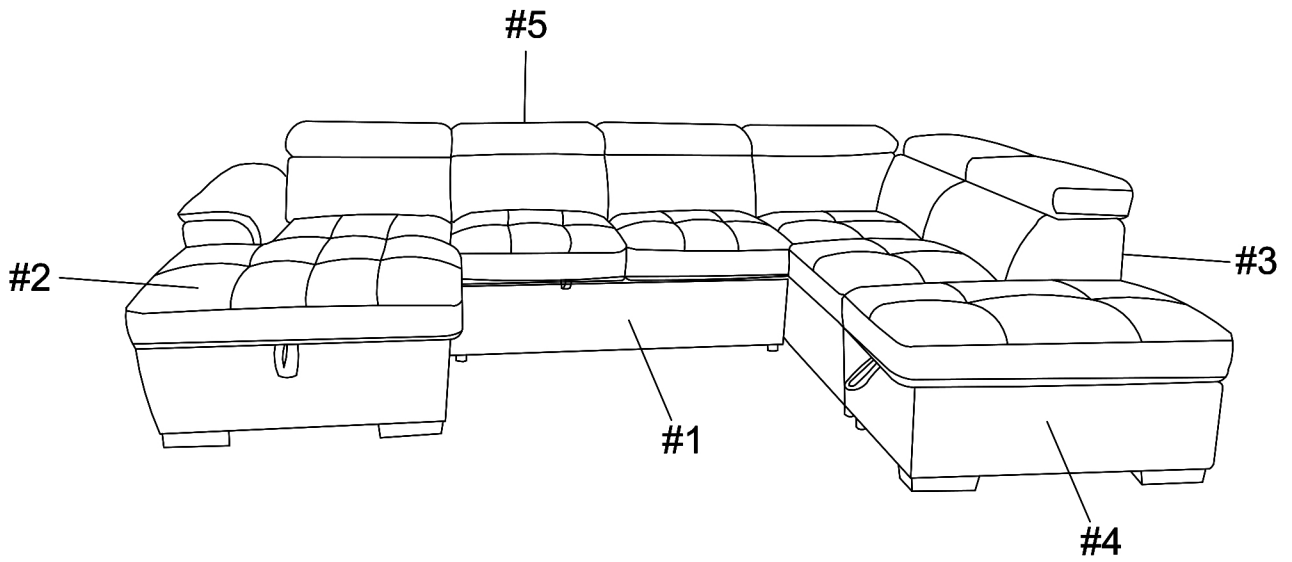



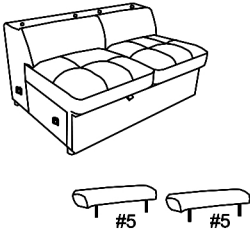
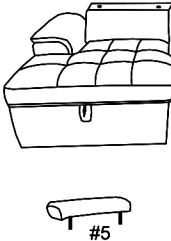

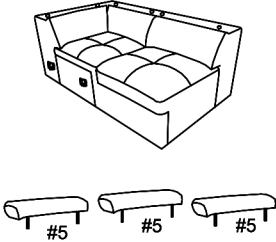

Screw #8X1-4/3"

Exploded View



packed in 4 cases

Carton	Disignation		Part	Hardware
	Loveseat	#1		
	Left Chaise	#2		 #A x 2pcs  #B x 1pc  #C x 2pcs  #D x 14pcs
	Right Chaise	#3		 #C x 4pcs  #D x 4pcs
	Ottoman	#4		 #A x 1pc  #B x 1pc  #C x 2pcs  #D x 10pcs

ASSEMBLY INSTRUCTIONS

1

Remove parts from all hidden compartments.

- Part #1 x1pc
- Part #2 x1pc
- Part #3 x1pc
- Part #4 x1pc

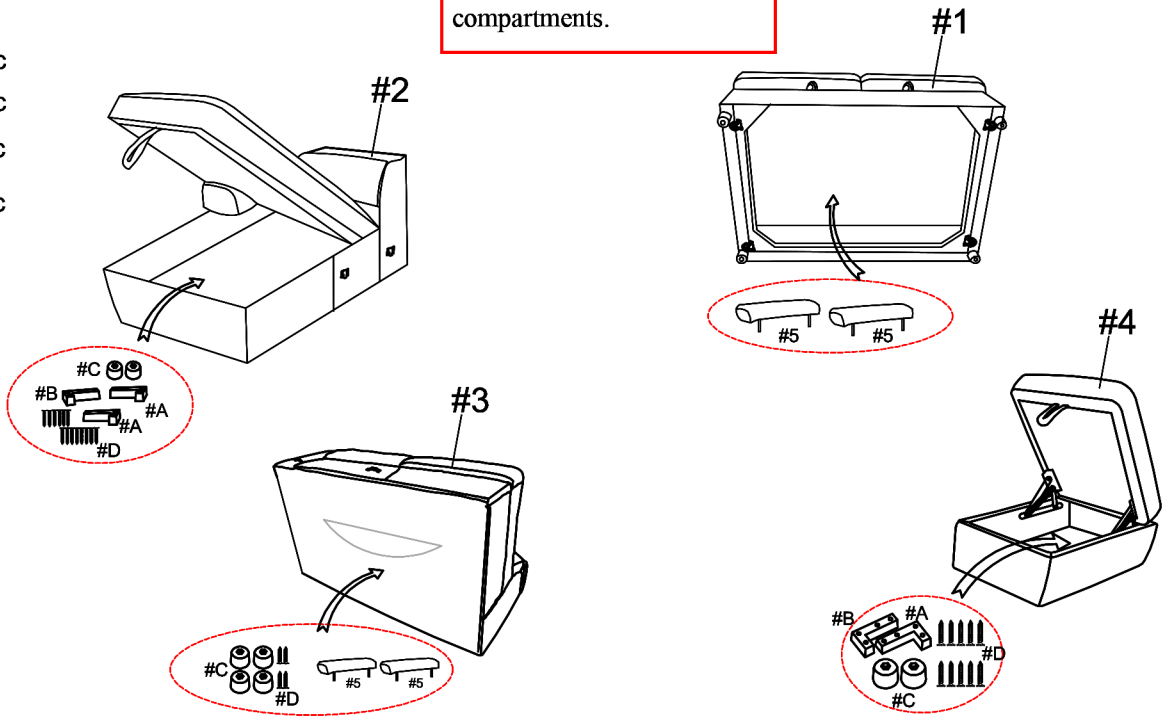

2

Secure legs (#A,B,C) to the bottom of the units, then secure by using screws (#D). There may not be pre-drilled holes at the bottom of the unit.

- Hardware #A x3pcs
- Hardware #B x2pcs
- Hardware #C x8pcs
- Hardware #D x28pcs

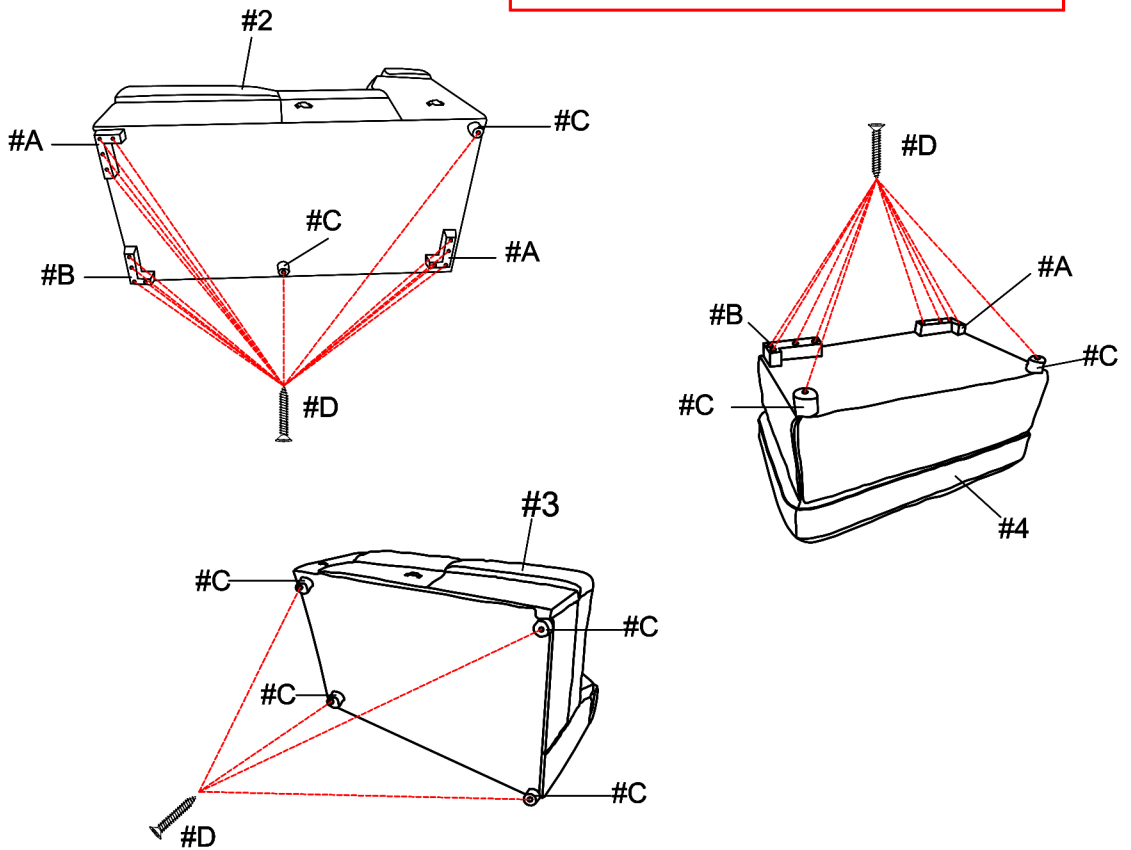

ASSEMBLY INSTRUCTIONS

3

Align and hook units together.

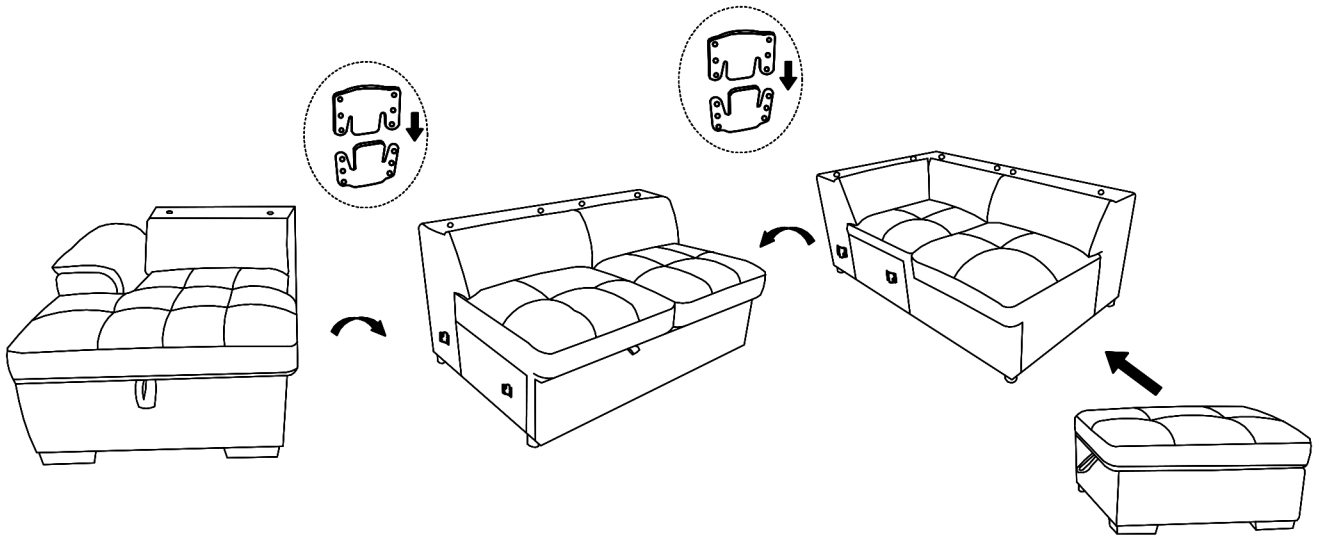

4

Attach the headrests (#5) onto the unit.

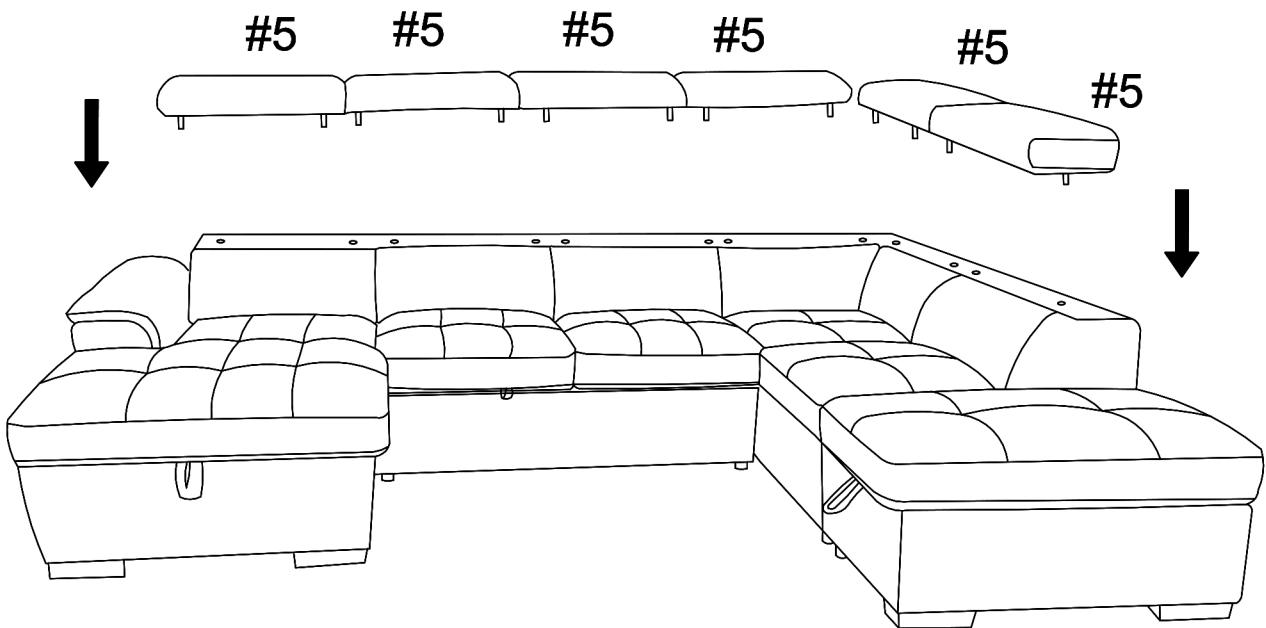

ASSEMBLY INSTRUCTIONS

5

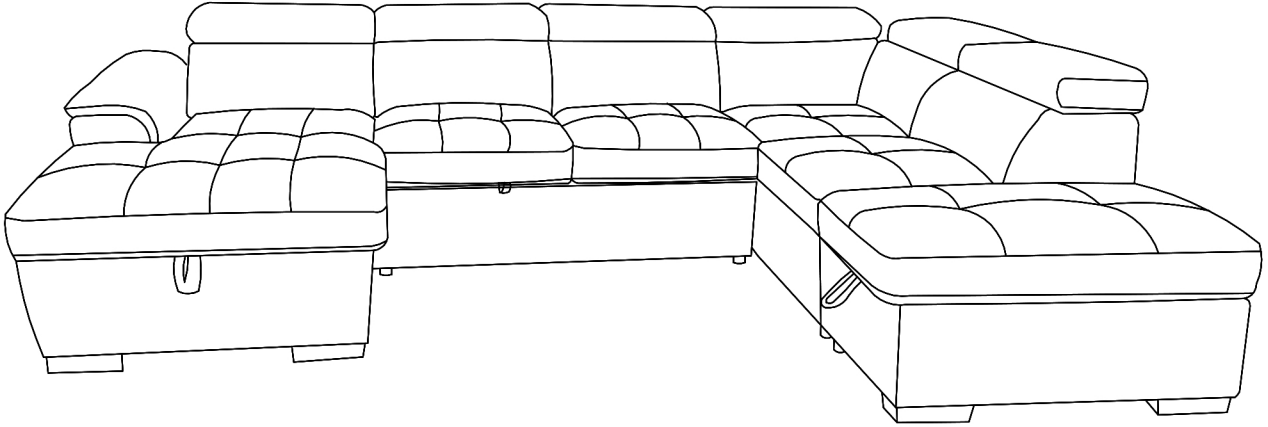

6

