

ASSEMBLY INSTRUCTIONS

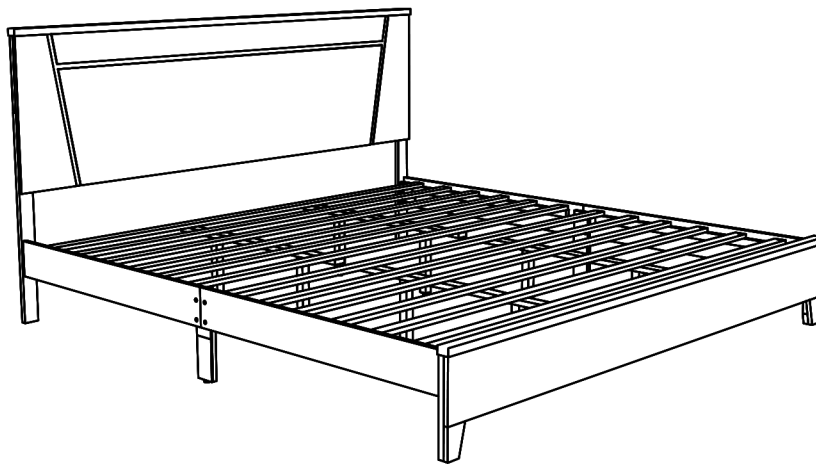

TOOLS REQUIRED

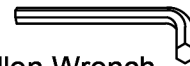

Allen Wrench

(Included)



Phillips
Screwdriver

(Not Included)



**3 - People
Recommended**

ASSEMBLY RATING



EASY ————— DIFFICULT

The Assembly Rating is a 5-point system showing the level of effort needed to assemble a specific product.



CHECK BEFORE STARTING

Are you missing anything?

Double-check all parts, hardware and accessories listed are all accounted for.

Should we send any replacements?

Are there any irregularities or flaws in the parts? We can send replacements!

Check out our Quick Tips!

We recommend reviewing the pre-assembly handouts. Even experts need a refresher now and then!

Prep Time!

Please review the assembly instructions and all diagrams prior to assembling.

PRE ASSEMBLY INTRODUCTION

We understand building ready-to-assemble furniture can be a challenging experience for some. To help avoid confusion, we have provided some helpful tips that may speed up the process.

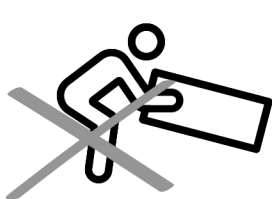

Teamwork

ALWAYS have at least two people to help with transporting and assembling the product to avoid potential injury and/or damage.

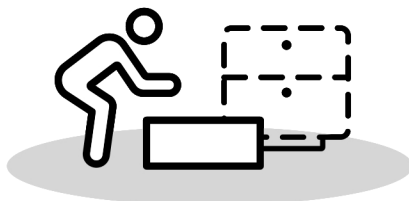
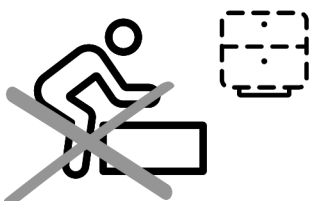

Suitable Location

Assembling near the area of the intended location is highly recommended.



Sufficient Space

Make sure you have enough space to move around during the assembly.

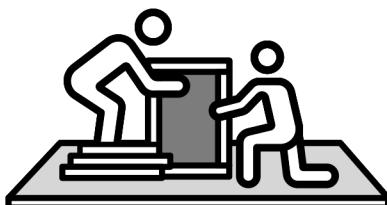

Avoid Scratches

Use cardboard, blankets or a carpeted area while assembling furniture to prevent to prevent scratches and damages.

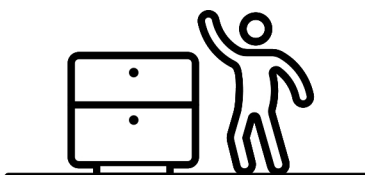
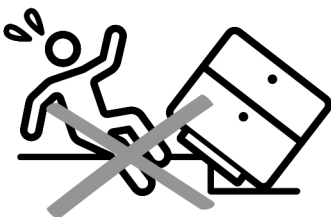

Flat Surface

Make sure the furniture rests on a flat and level surface with each leg evenly touching the floor.

ASSEMBLY AND CARE ADVICE



FAILURE TO FOLLOW THE GUIDELINES BELOW MAY RESULT IN INJURY AND/OR PROPERTY DAMAGE.



Position each part correctly and insert screws or bolts into their respective holes.

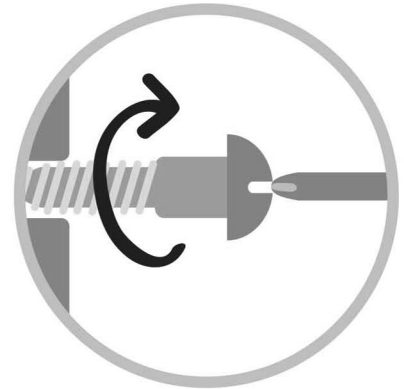

Turn clockwise to tighten and only tighten when step is completed or when instructed to do so.



Save the instructions and store any supplied tools for later maintenance.

Use the appropriate hand tools or power tools for assembly. Select steps, such as tightening screws and/or bolts, may require hand tools to avoid causing damage during assembly.



After two weeks, check and tighten any loose hardware and repeat again every six months thereafter.

IT IS THE USER'S RESPONSIBILITY TO MAINTAIN THE FURNITURE. THE HARDWARE MAY LOOSEN OVER TIME AND MAY CAUSE THE FURNITURE TO BE WOBBLY AND UNABLE TO SUPPORT ITS INTENDED WEIGHT CAPACITY. THIS MAY LEAD TO COLLAPSE AND MAY CAUSE SERIOUS INJURY.







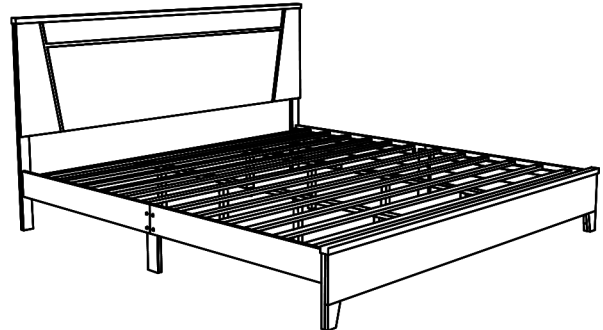

CALI. KING SIZE BED









- Please keep instructions for future reference.
- Check the quantity and irregularity of parts and hardware before you start.



PARTS

#1 1pc  Headboard	#2 1pc  Footboard	#3 2pcs  Headboard Leg(L&R)	#4 2pcs  Side Rail Left	#5 2pcs  Side Rail Right	#6 2pcs  Side Rail Support Leg
#7 12pcs  Bed Slat - 1845x45x18mm	#8 8pcs  Bed Slat Support - 248x30x30mm	#9 4pcs  Bed Center Slat - 940x45x18mm			

HARDWARE

#A 12pcs  Bolt 1/4" x 1-3/16"	#B 8pcs  Bolt 1/4" x 2"	#C x 12pcs  Lock washer	#D x 12pcs  Flat washer	#E 32pcs  CSK M4 x 32mm
#F 1pc  Allen Key M4 x 65mm	#G 1pc  Allen Key M5 x 65mm			

ASSEMBLY INSTRUCTIONS

1

Align headboard legs (#3) to the headboard (#1). Secure using bolts (#A) with washers (#C,D) and screws (#E).

- Part #1 x1pc
- Part #3 x2pcs
- Hardware #A x4pcs
- Hardware #C x4pcs
- Hardware #D x4pcs
- Hardware #E x8pcs

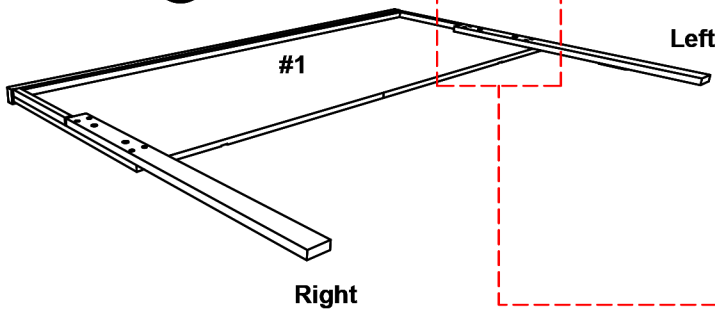

STEP 1.1 :

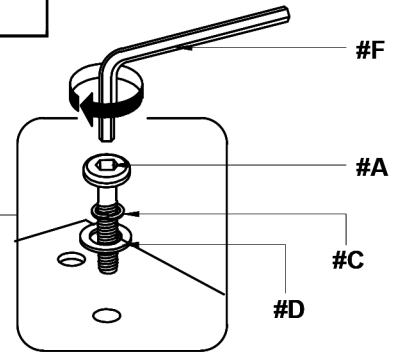
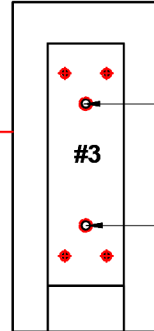

STEP 1.2 :

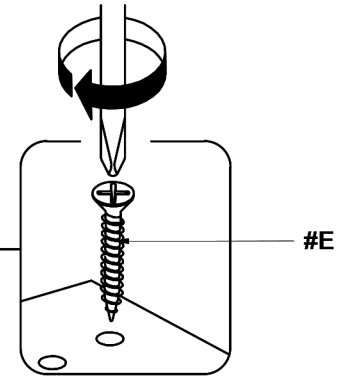
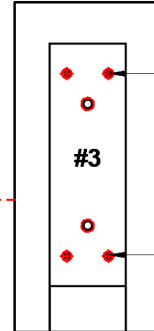

2

- Part #4 x2pcs
- Part #5 x2pcs
- Part #6 x2pcs
- Hardware #A x8pcs
- Hardware #C x8pcs
- Hardware #D x8pcs

Align side rails (#4,5) with side rail support (#6). Secure using bolts (#A) with washers (#C,D).

X2

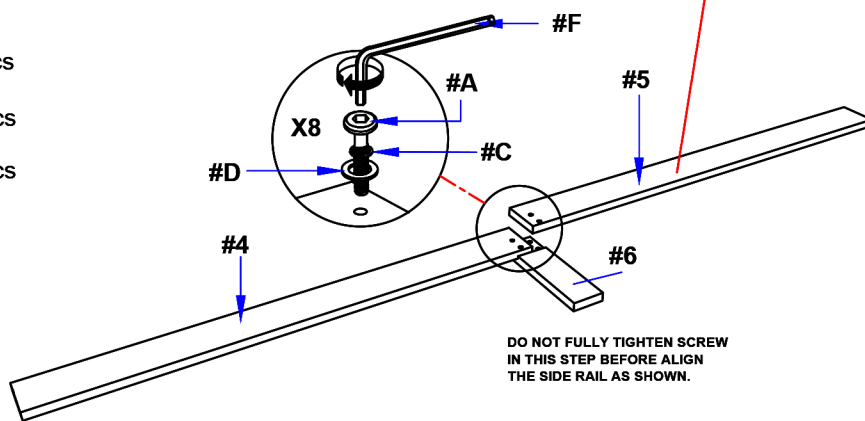

ASSEMBLY INSTRUCTIONS

3

Part #2 x1pc

Align the side rails (#4,5) to the headboard (#1) and footboard (#2). Secure by tightening the bolts.

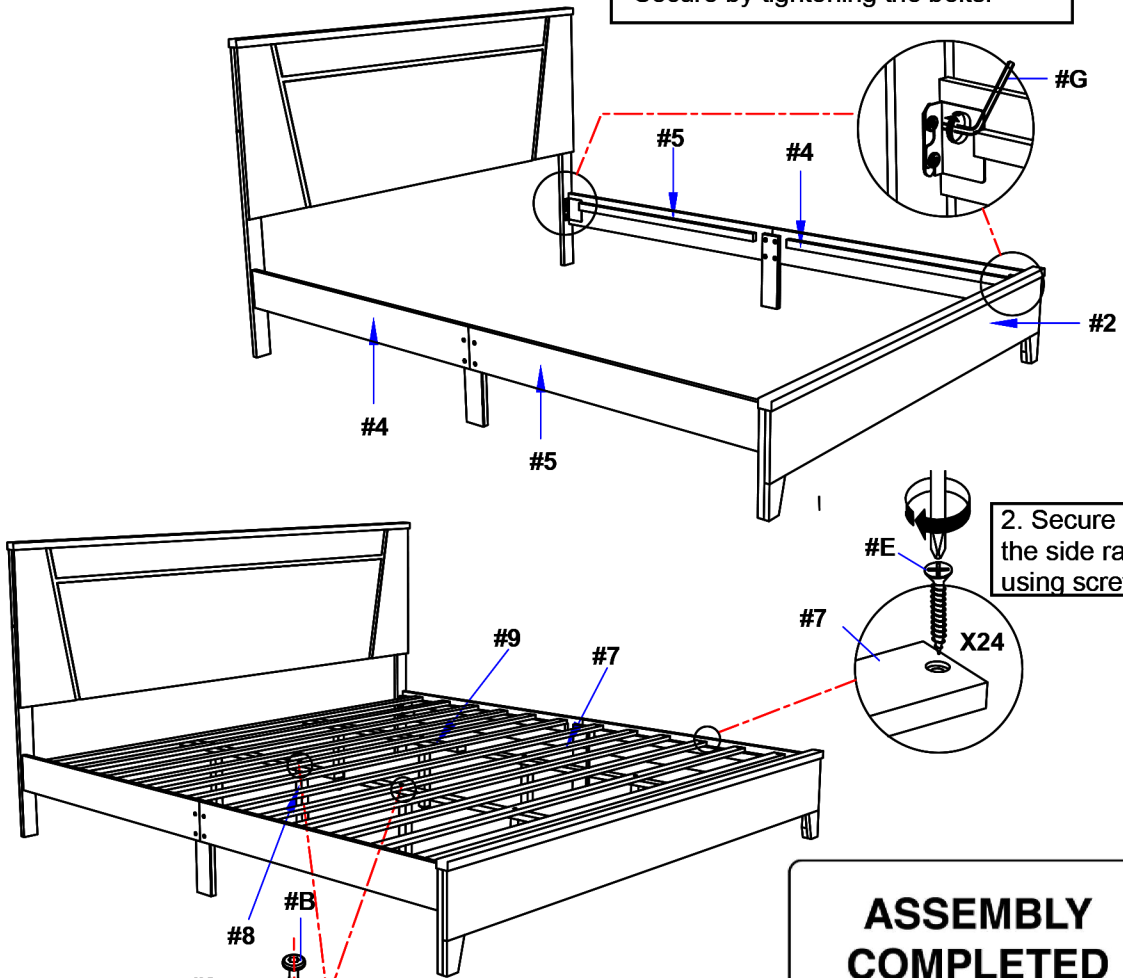

2. Secure slats (#7) to the side rails (#4,5) by using screws (#E).

4

Part #7 x12pcs

Part #8 x8pcs

Part #9 x4pcs

Hardware #B x8pcs

Hardware #E x24pcs

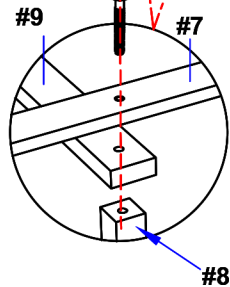

1. Attach the slat support legs (#8) to the center slat (#9) and the bed slats (#7) by using bolts (#B).

ASSEMBLY COMPLETED



Please ensure the furniture rests on an even and flat surface. If the product wobbles or feels loose, double-check all bolts and/or screws are properly tightened and secured.

✓ Keep this handy!

Please retain this instruction manual and any order-related information for future reference.

✓ Lift, don't drag!

To avoid damage to product please always LIFT the product when transporting or adjusting the placement.