

# ASSEMBLY INSTRUCTIONS

---

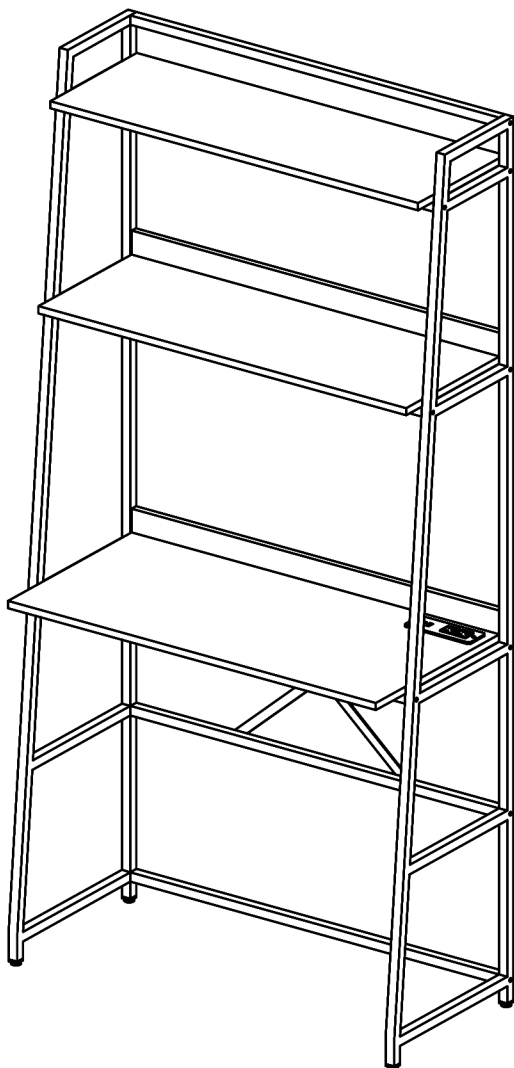

## TOOLS REQUIRED



Allen Wrench

(Included)



Wrench

(Included)

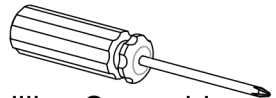

Phillips Screwdriver

(Not Included)



2 - People  
Recommended

## ASSEMBLY RATING



EASY —————> DIFFICULT

The Assembly Rating is a 5-point system showing the level of effort needed to assemble a specific product.



## **CHECK BEFORE STARTING**

### **Are you missing anything?**

Double-check all parts, hardware and accessories listed on Page 6 are accounted for.

### **Check out our Quick Tips!**

We recommend reviewing the pre-assembly handouts. Even experts need a refresher now and then!

### **Should we send any replacements?**

Are there any irregularities or flaws in the parts? We can send replacements!

### **Prep Time!**

Please review the assembly instructions and all diagrams prior to assembling. Arrange parts as recommended on Page 7 and group identical hardware together to make assembling easier.

# PRE ASSEMBLY INTRODUCTION

We understand building ready-to-assemble furniture can be a challenging experience for some. To help avoid confusion, we have provided some helpful tips that may speed up the process.

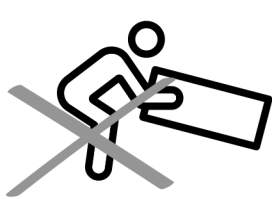

## Teamwork

ALWAYS have at least two people to help with transporting and assembling the product to avoid potential injury and/or damage.

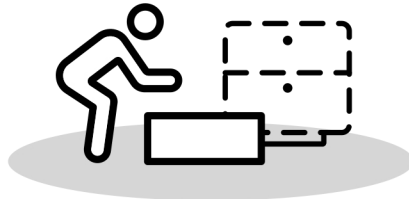
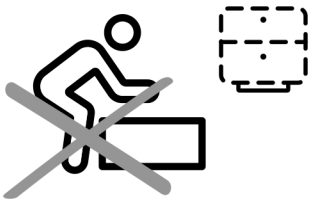

## Suitable Location

Assembling near the area of the intended location is highly recommended.



## Sufficient Space

Make sure you have enough space to move around during the assembly.

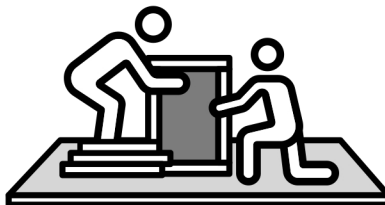

## Avoid Scratches

Use cardboard, blankets or a carpeted area while assembling furniture to prevent scratches.

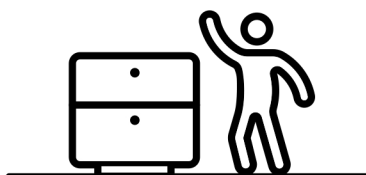
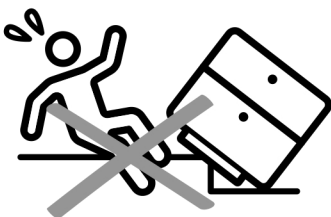

## Flat Surface

Make sure the furniture rests on a flat and level surface with each leg evenly touching the floor.

# ASSEMBLY AND CARE ADVICE



**FAILURE TO FOLLOW THE GUIDELINES BELOW MAY RESULT IN INJURY AND/OR PROPERTY DAMAGE.**



Position each part correctly and insert screws or bolts into their respective holes.

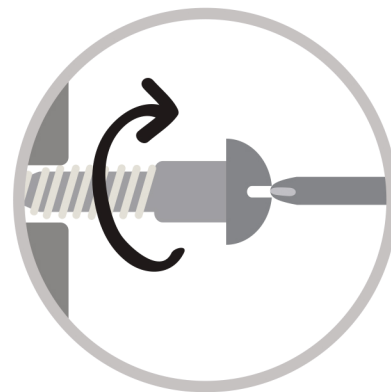

Turn clockwise to tighten and only tighten when step is completed or when instructed to do so.



Use the appropriate hand tools or power tools for assembly. Select steps, such as tightening screws and/or bolts, may require hand tools to avoid causing damage during assembly.



Save the instructions and store any supplied tools for later maintenance.

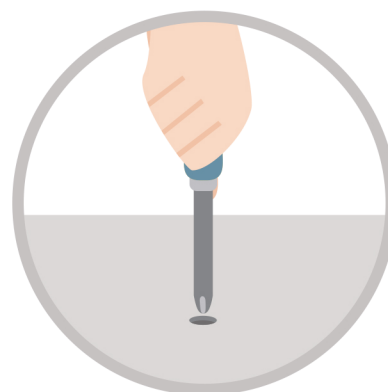

After two weeks, check and tighten any loose hardware and repeat again every six months thereafter.

**IT IS THE USER'S RESPONSIBILITY TO MAINTAIN THE FURNITURE. THE HARDWARE MAY LOOSEN OVER TIME AND MAY CAUSE THE FURNITURE TO BE WOBBLY AND UNABLE TO SUPPORT ITS INTENDED WEIGHT CAPACITY. THIS MAY LEAD TO COLLAPSE AND MAY CAUSE SERIOUS INJURY.**

# WRITING DESK WITH BOOKCASE & USB PLUG



- Please keep instructions for future reference.
- Check the quantity and irregularity of parts and hardware before you start.

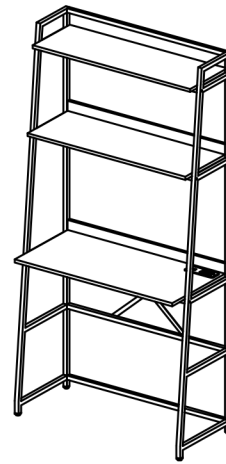

## PARTS

#1 2pcs

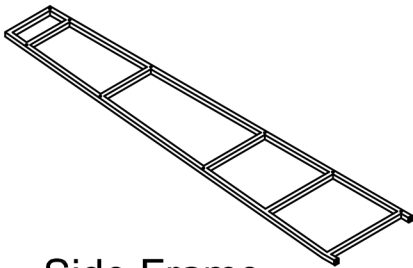

Side Frame

#2 5pcs

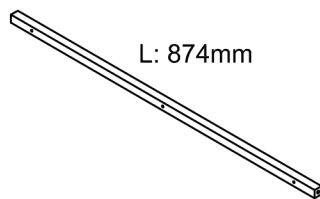

Cross Tube-6 holes-

#3 1pc

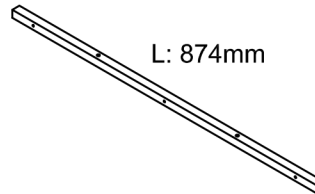

Cross Tube-8 holes-

#4 1pc

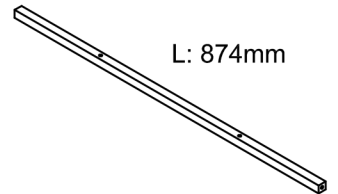

Cross Tube-2 holes-

#5 2pcs

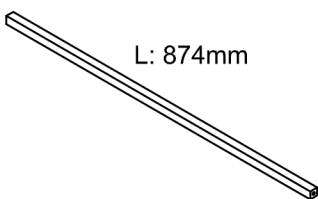

Cross Tube-0 hole-

#6 2pcs

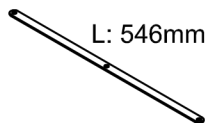

Cross Sheet

#7 1pc

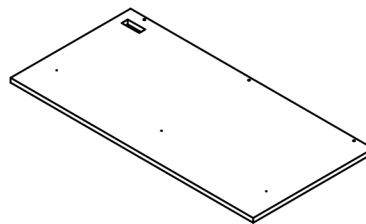
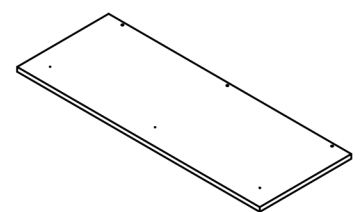

Table Board

#8 1pc



Shelf Board

#9 1pc

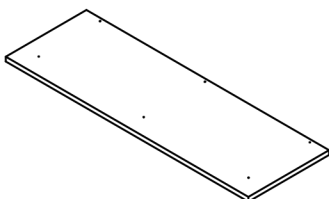

Top Shelf Board

#10 2pcs

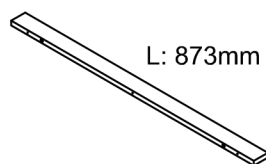

Back Panel

#11 1pc

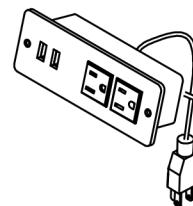

USB Scket

HARDWARE

#A 18pcs

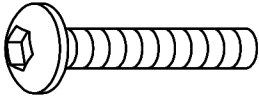

Bolt 1/4" \* 32mm

#B 5pcs

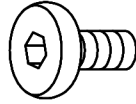

Bolt 1/4" \* 12mm

#C 6pcs



Screw 8# \* 41mm

#D 12pcs

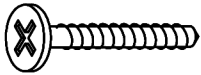

Screw 8# \* 32mm

#E 2pcs



Screw 6# \* 12mm

#F 1pc

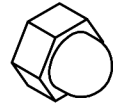

Acorn Nut

#G 4pcs

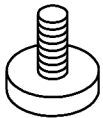

Leveler

#H 4pcs

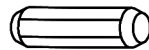

Dowel

#I 1pc

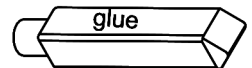

Glue

#J 2pcs

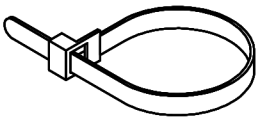

Safety Strap

#K 2pcs

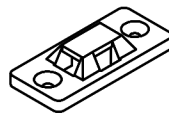

Plastic Bracket

#L 4pcs



Anchor

#M 4pcs



Screw

#N 1pc

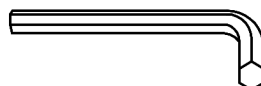

Allen Wrench

#O 1pc



Wrench

# ASSEMBLY INSTRUCTIONS

Please pay attention to the orientation of the tubs (#2,3,4,5) based off of the holes as shown in the diagram below.

## 1

- Part #1 x2pcs
- Part #2 x5pcs
- Part #3 x1pc
- Part #4 x1pc
- Part #5 x2pcs
- Hardware #A x18pcs

\*\*Make sure to keep the 2-holes side of the cross tubes (#3, #4) face up.

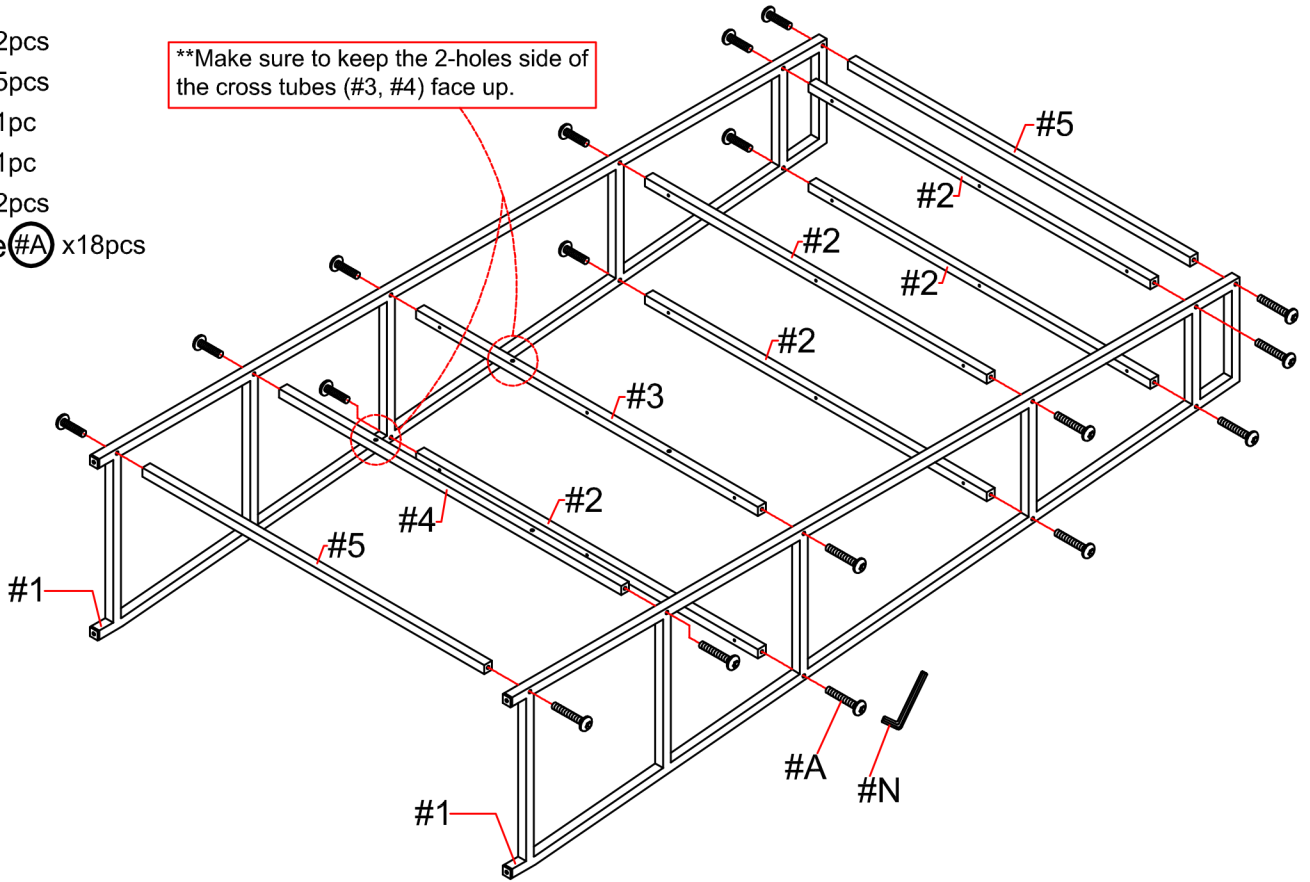

## 2

2) Secure cross sheets (#6) together by using bolt (#B) with nut (#F).

- Part #6 x2pcs
- Hardware #B x5pcs
- Hardware #F x1pc
- Hardware #G x4pcs

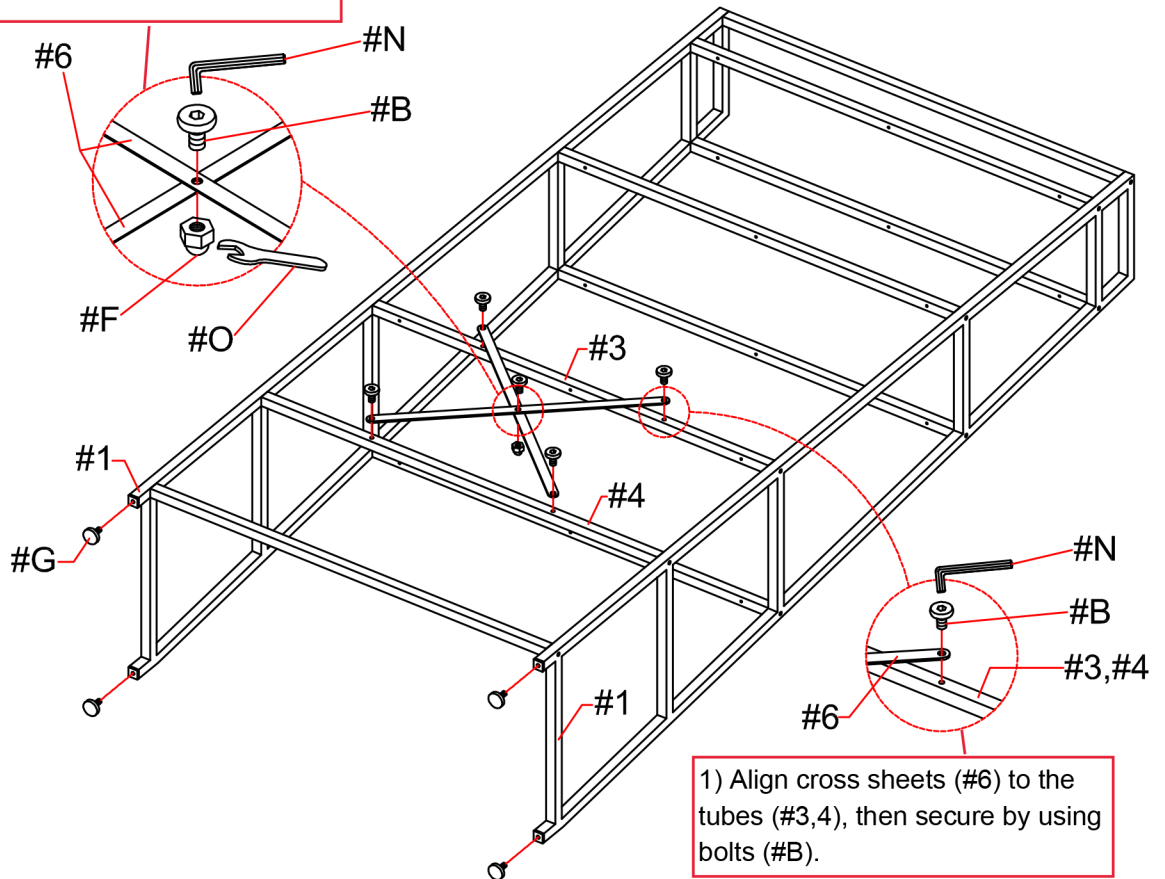

1) Align cross sheets (#6) to the tubes (#3,4), then secure by using bolts (#B).

# ASSEMBLY INSTRUCTIONS

## 3

Part #9 x1pc  
Hardware #D x6pcs

Align shelf (#9) to the frame, then secure by using screws (#D).

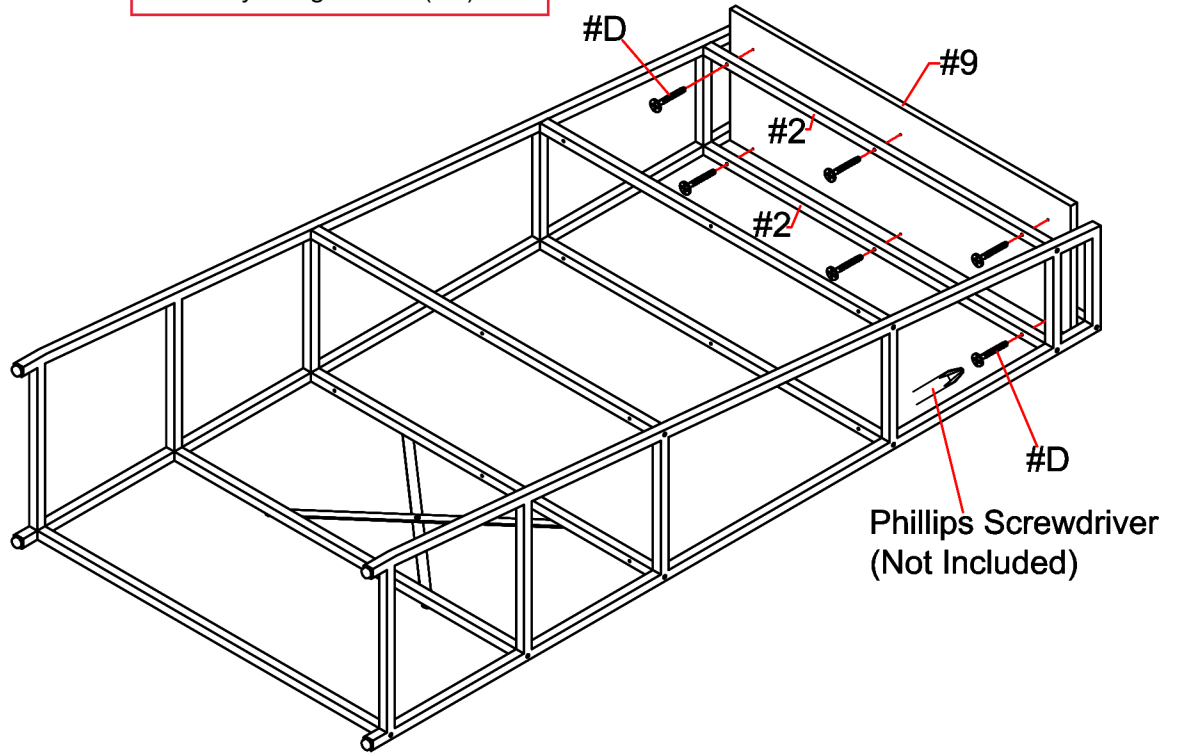

## 4

Part #8 x1pc  
Part #10 x1pc  
Hardware #C x3pcs  
Hardware #D x3pcs  
Hardware #H x2pcs

Insert dowels (#H) with a dab of glue (#I) to the shelf (#8) and back panel (#10). Align shelf (#8) to the frame, then secure by using screws (#D).

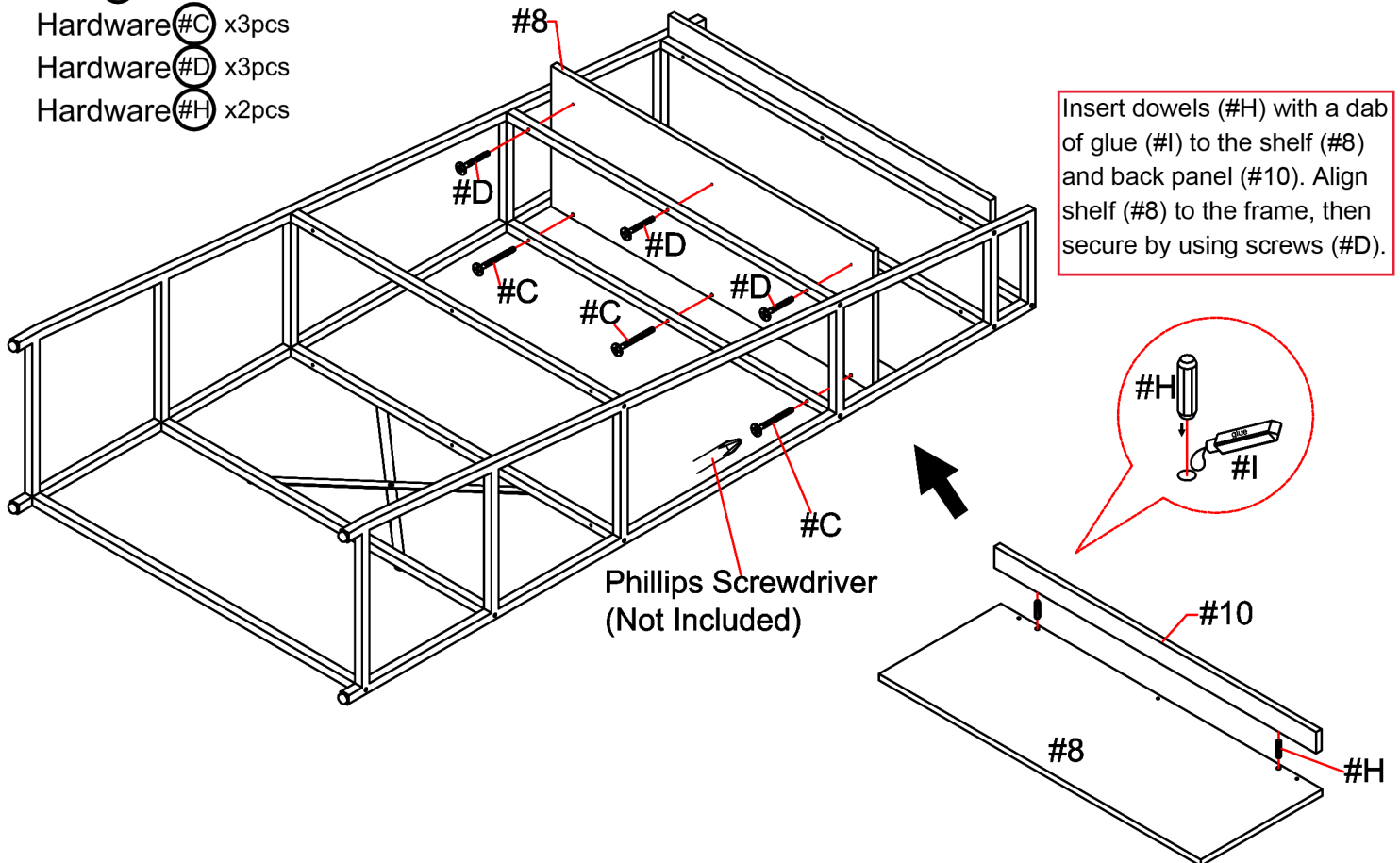

# ASSEMBLY INSTRUCTIONS

## 5

- Part #7 x1pc
- Part #10 x1pc
- Hardware #C x3pcs
- Hardware #D x3pcs
- Hardware #H x2pcs

Insert dowels (#H) with a dab of glue (#I) to shelf (#7) and back panel (#10). Align shelf (#7) to the frame, then secure by using bolts (#D).

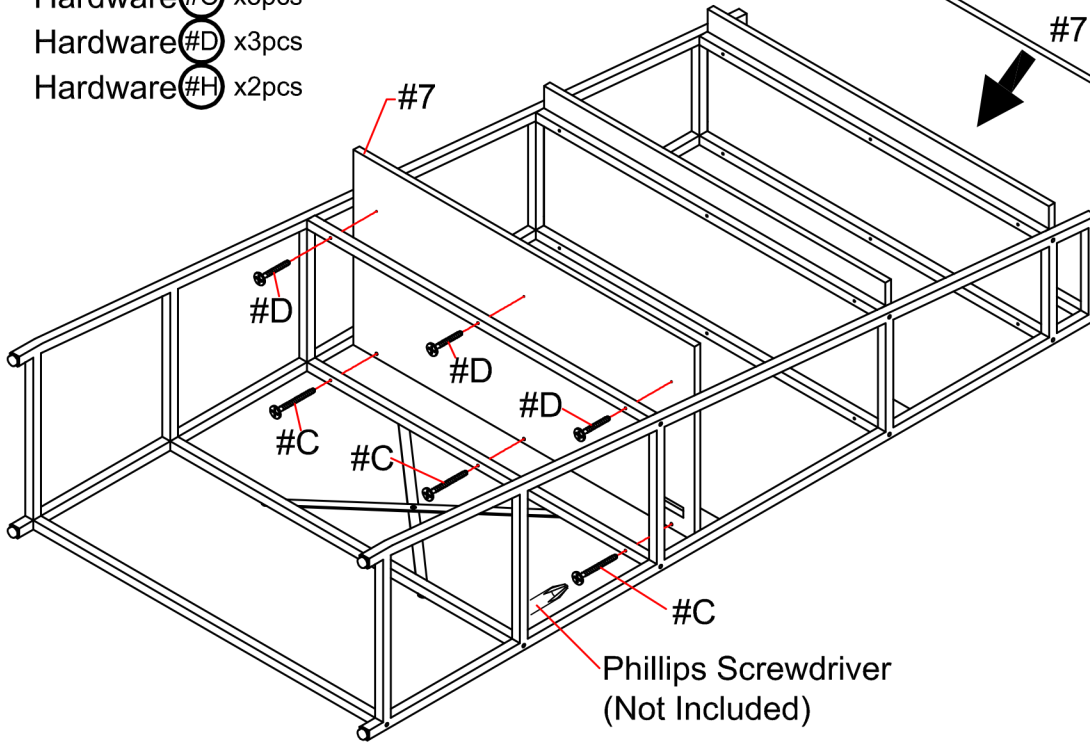

Phillips Screwdriver  
(Not Included)

## 6

- Part #11 x1pc
- Hardware #E x2pcs

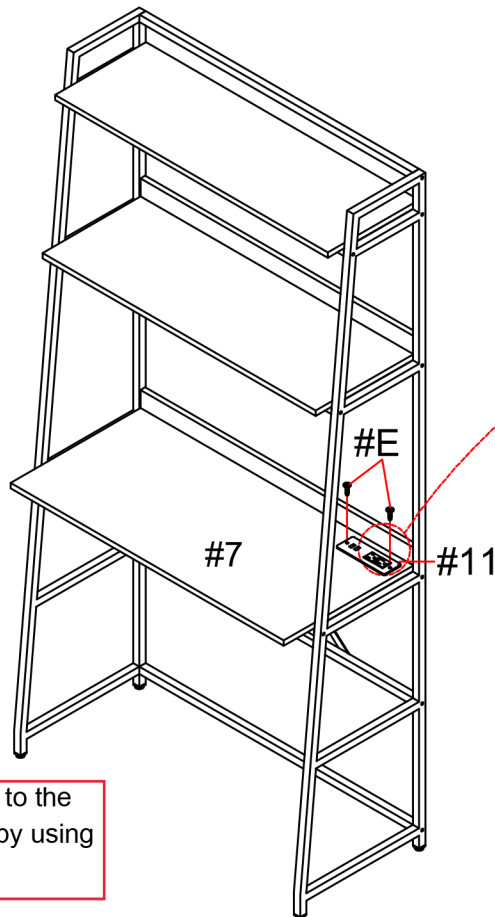

Align USB socket (#11) to the shelf (#7), then secure by using screws (#E).

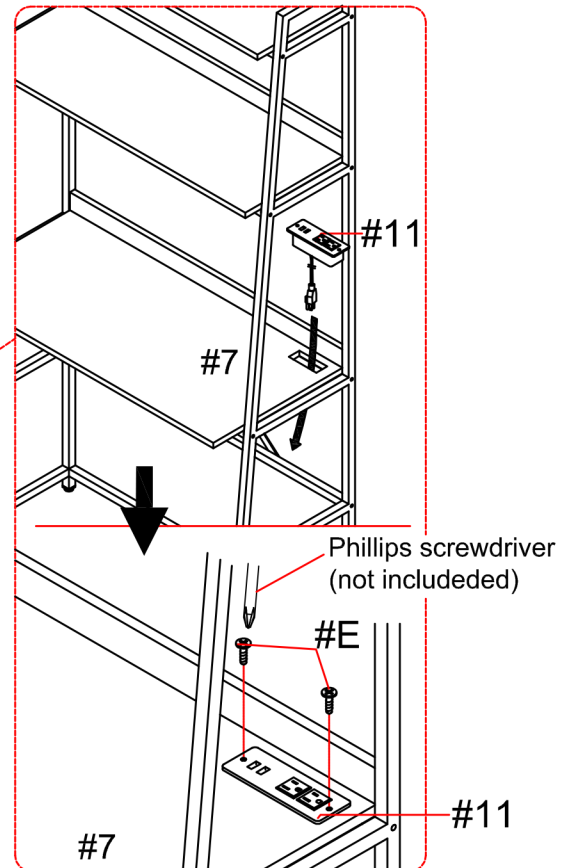

Phillips screwdriver  
(not included)

# ASSEMBLY INSTRUCTIONS

## 7

- Hardware #J x2pcs
- Hardware #K x2pcs
- Hardware #L x4pcs
- Hardware #M x4pcs

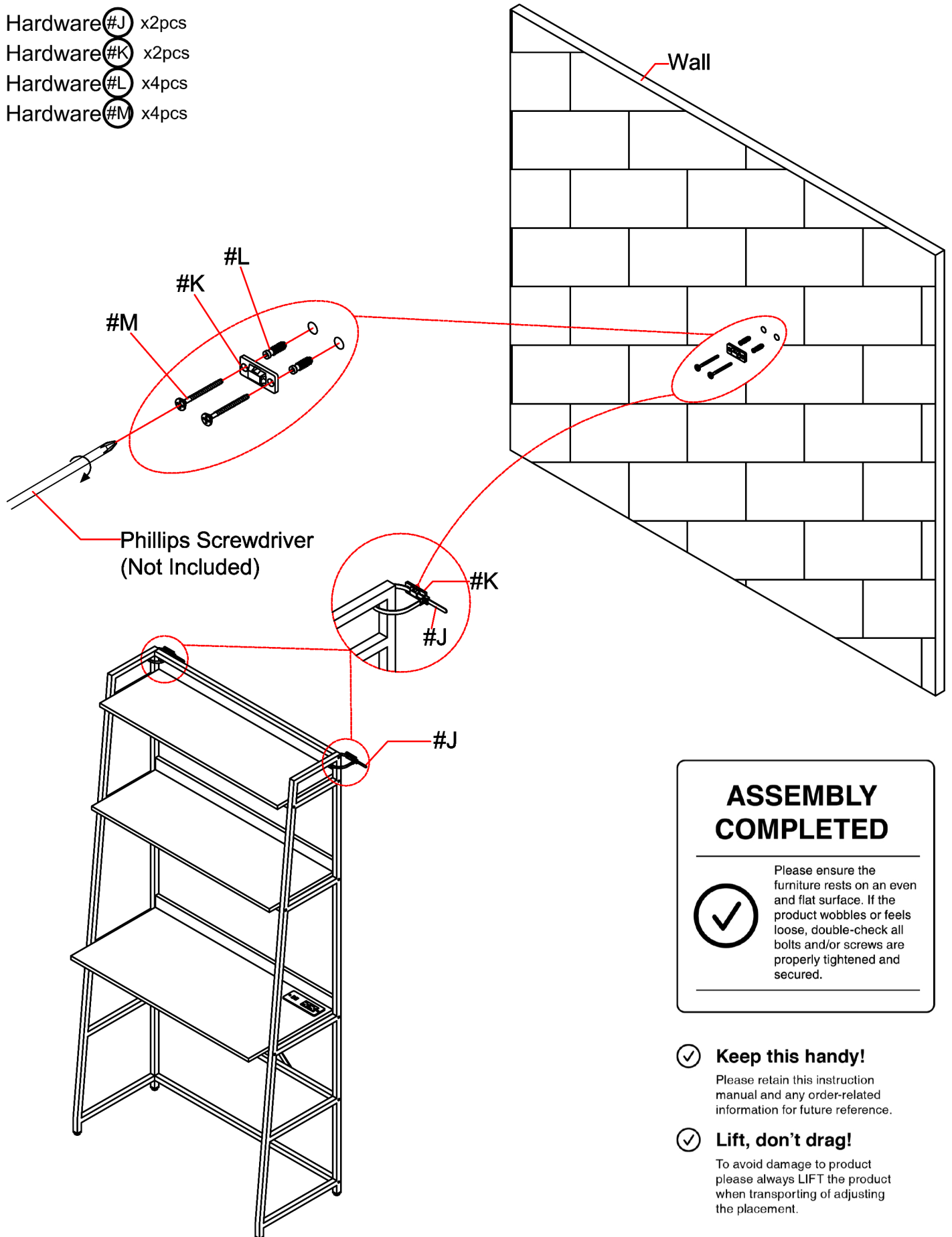

Phillips Screwdriver  
(Not Included)

## ASSEMBLY COMPLETED



Please ensure the furniture rests on an even and flat surface. If the product wobbles or feels loose, double-check all bolts and/or screws are properly tightened and secured.



### Keep this handy!

Please retain this instruction manual and any order-related information for future reference.



### Lift, don't drag!

To avoid damage to product please always LIFT the product when transporting or adjusting the placement.

# ASSEMBLY INSTRUCTIONS

## Wall Mounting and Fixing



### EXPANSION WALL ANCHOR

Our provided expansion wall anchors are only suitable for masonry walls, such as drywall, plaster or concrete, and are best for holding lightweight items or for anti-tip prevention. If you are unsure of the correct wall anchor to use with the product, please request professional guidance. Liability for product damage or failure due to using the incorrect anchors will fall on the installer.

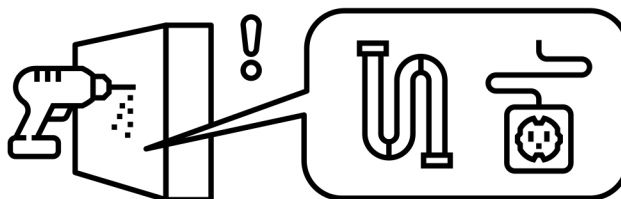

### CHECK BEFORE PROCEEDING

Prior to drilling or hammering, please check for wires or pipes. We recommend using a stud finder to locate a stud, which will offer more appropriate resistance and hold more weight.

## QUICK TIPS

1. If unsure of the proper size, always choose a larger screw and wall anchor.

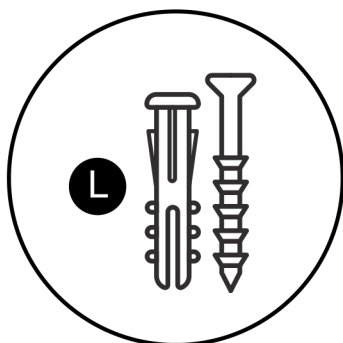

2. Match the drill bit to the wall anchor and hole size.

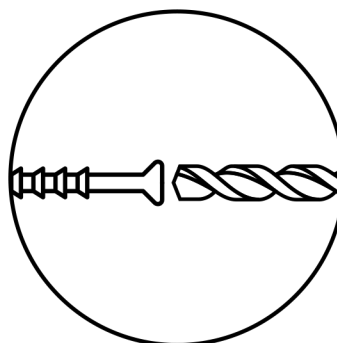

3. Only drill horizontally. Do not force the drill or enlarge the hole for the wall anchor.

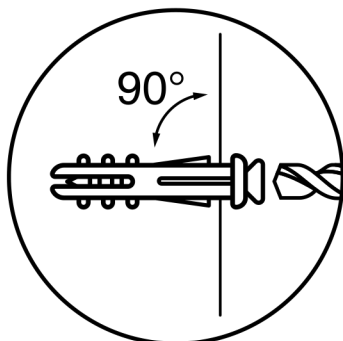

4. Take extra care when drilling into high walls or ceramic tiles. Wall anchors should be a tight fit for the hole. Never use wall anchors in ceilings.

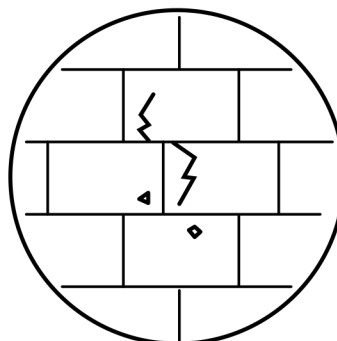

### MAINTENANCE



We recommend a yearly check to see if the wall anchor or screw has loosened. If so, please remove the existing wall anchor and screw, and use a new anchor.