

Assembly Instructions

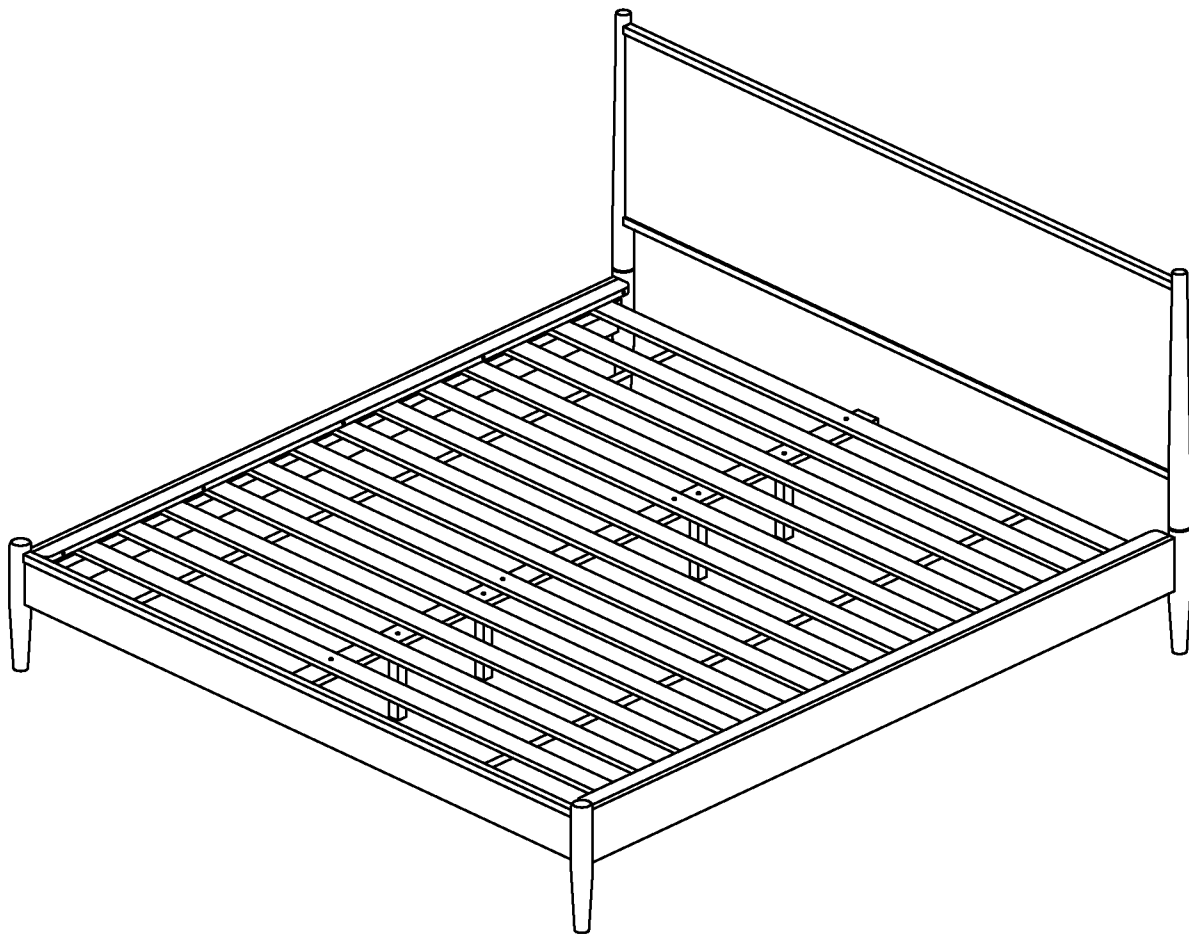

ASSEMBLY RATING

The Assembly Rating is a 5-point system that shows the degree of effort needed in assembling a specific product (with 1 being easy and 5 being difficult). For some products, two persons are recommended.

EASY  DIFFICULT

Tools Required For Assembly:

Allen Wrench

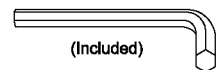

Phillips Screwdriver

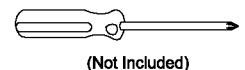

2 PERSONS RECOMMENDED

ASSEMBLY & CARE ADVICE

FOR YOUR FURNITURE TO LAST, CORRECT ASSEMBLY AND PROPER MAINTENANCE ARE NECESSARY. PLEASE FOLLOW THE INFORMATION PROVIDED BELOW TO FULLY ENJOY YOUR FURNITURE.

BASIC ASSEMBLY TECHNIQUES

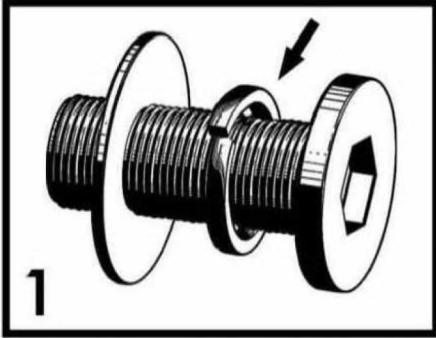

When lock or spring washer is used in an assembly, please make sure the lock or spring washer is placed between the larger flat washer and the head of the screw or bolt.

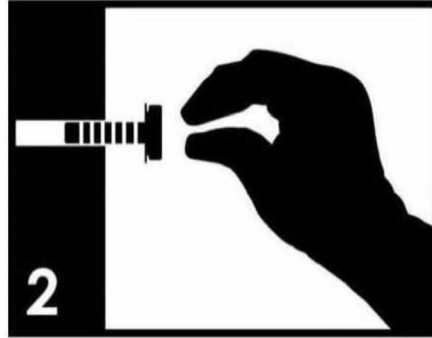

Position each part correctly and insert screws or bolts into their respective holes by hand tighten or using the proper hand tool. Only tighten when step is completed or when instructed to do so.

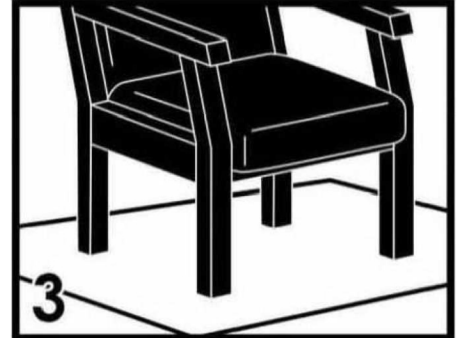

Use cardboard or carpet area when assembling furniture to prevent scratches. Make sure the furniture rests on a flat and level surface with each leg evenly touching the floor.

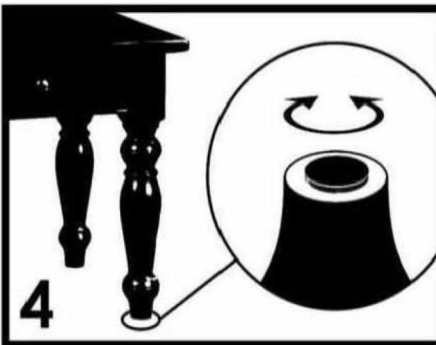

Some furniture comes with height adjustment knobs underneath each leg. To lower or to raise each leg, you need to turn clockwise or counterclockwise, respectively.

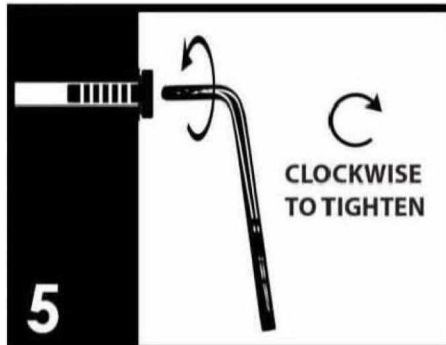

Make sure all parts are properly aligned, then use the appropriate hand tool to completely tighten the bolts or screws. Do not use power tools and do not overtighten.

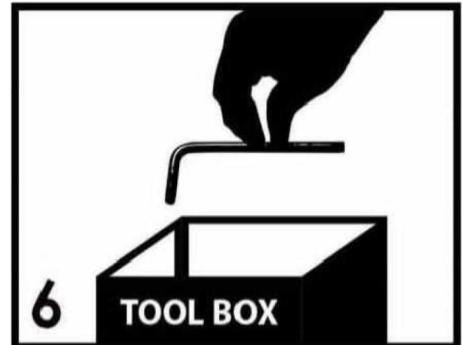

Save the instructions and store the Allen wrench or any supplied tool for later maintenance. After two weeks, check and tighten any loose hardware and repeat again every six months thereafter.

IT IS THE USER'S RESPONSIBILITY TO MAINTAIN THE FURNITURE. THE HARDWARE MAY LOOSEN OVER TIME AND MAY CAUSE THE FURNITURE TO BE WOBBLY AND UNABLE TO SUPPORT ITS INTENDED WEIGHT CAPACITY. THIS MAY LEAD TO COLLAPSE AND MAY CAUSE SERIOUS INJURY.



FAILURE TO FOLLOW THE GUIDELINES ABOVE MAY RESULT IN INJURY AND/OR PROPERTY DAMAGE.

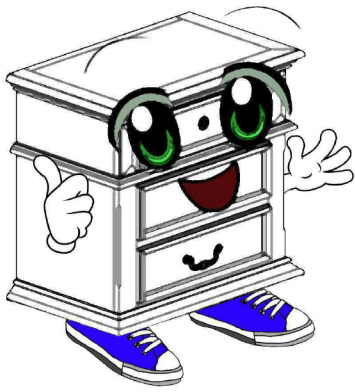

Before you begin, please read Page 2 of "Assembly and Care Advice".

And remember, do not tighten until each step is completed or instructed.

Parts List

Hardware List

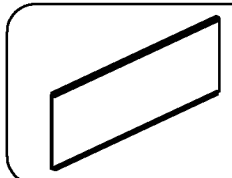

#1 x 1pc
Headboard



#A x 16pcs
Bolt $\text{\O}1/4"$ x 1-3/8"

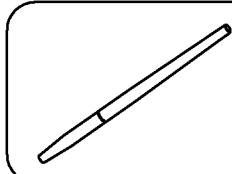

#2 x 2pcs
Headboard Leg (L&R)



#B x 16pcs
Lock washer $\text{\O}1/4"$

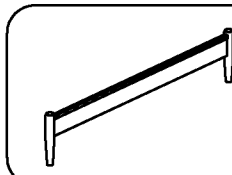

#3 x 1pc
Footboard



#C x 6pcs
Flat washer $\text{\O}1/4"$ -3/4"

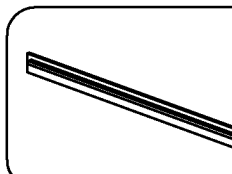

#4 x 2pcs
Side Rail



#D x 1pc
Allen wrench M4

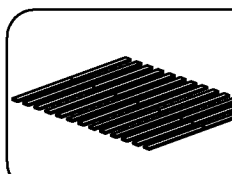

#5 x 1Set (13pcs)
Bed Slat



#E x 12pcs
Screw 5/32"x1-3/16"

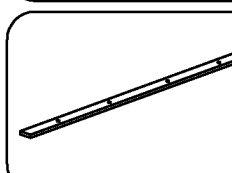

#6 x 1pc
Center Rail



#F x 10pcs
Flat washer $\text{\O}1/4"$ -1/2"

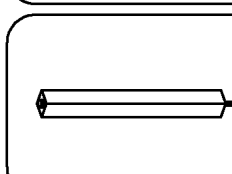

#7 x 4pcs $\text{\O}5/16"$
Support Leg (310x30x30mm)



#8 x 2pcs
Side Rail Top Panel



#1

#A x 6pcs
#B x 6pcs
#C x 6pcs

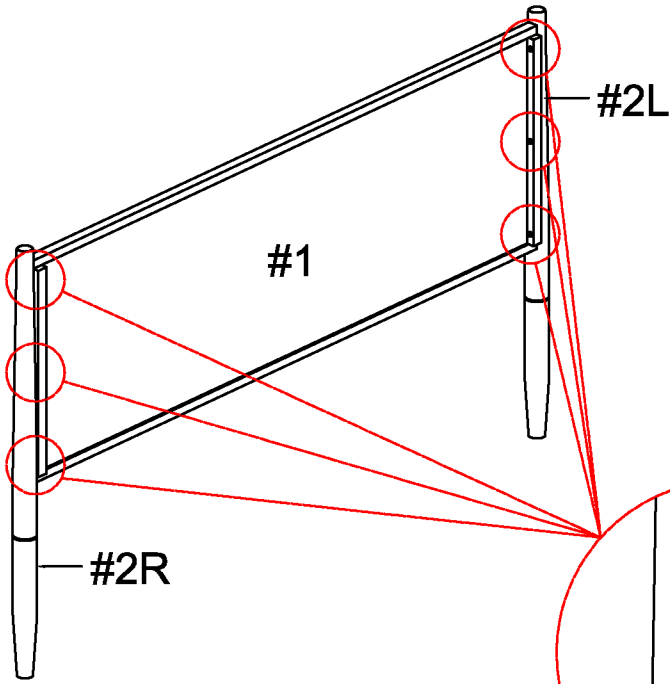

1. Prepare 6 bolt assemblies by first inserting a lock washer (#B) onto the bolt (#A) then a flat washer (#C) onto that same bolt (#A).

2. Align the legs (#2) to the holes along the side of the headboard (#1), then insert the bolts and secure.

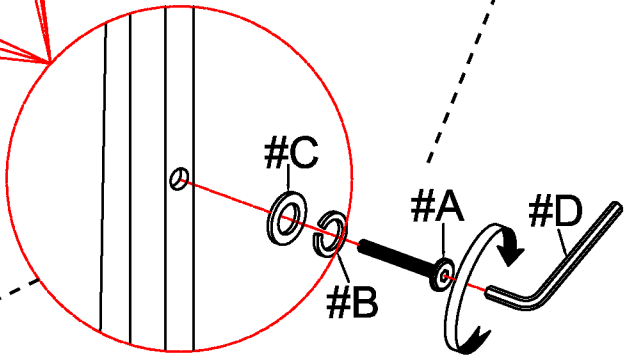

#2

Hook each end of the side rails (#4) onto the slots along the headboard (#1) and foot board (#3).

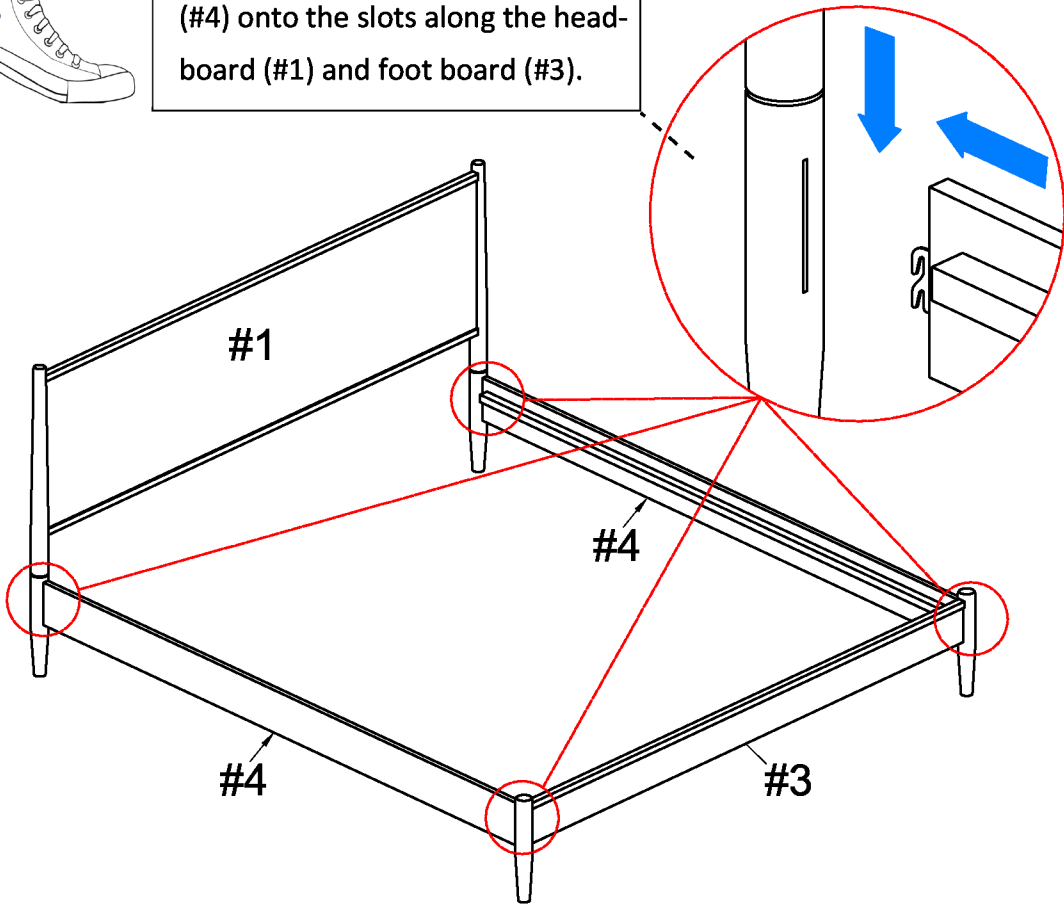



#3

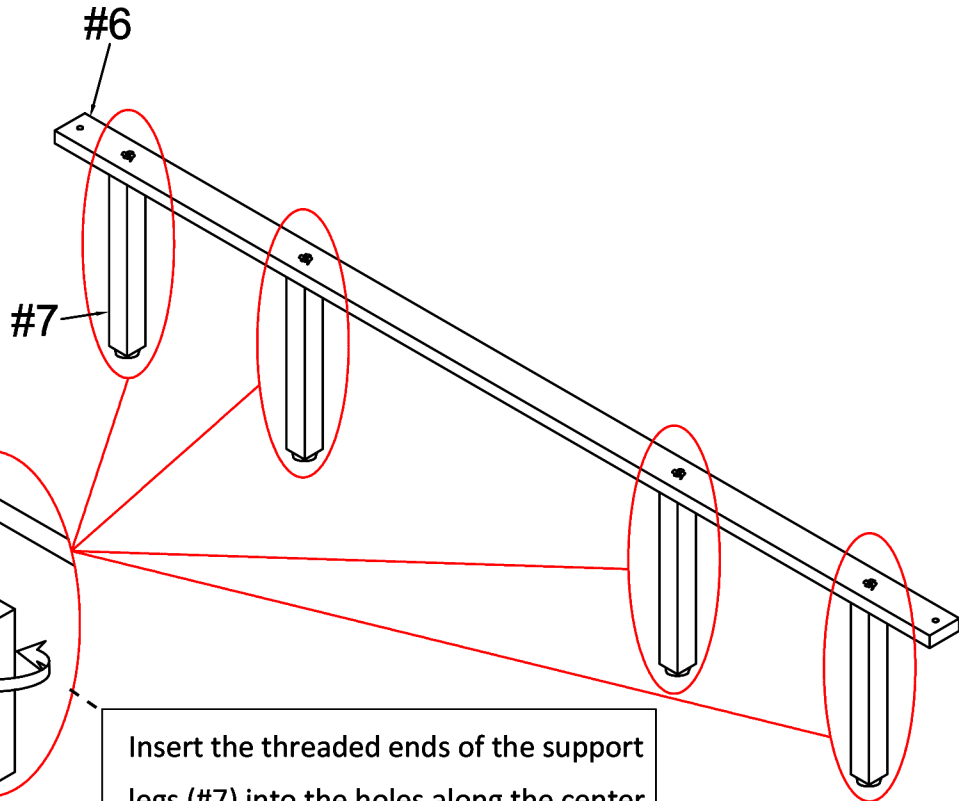

Insert the threaded ends of the support legs (#7) into the holes along the center rail (#6), turn right to tighten.

Adjust according to the ground level.



#4

#E x 12pcs

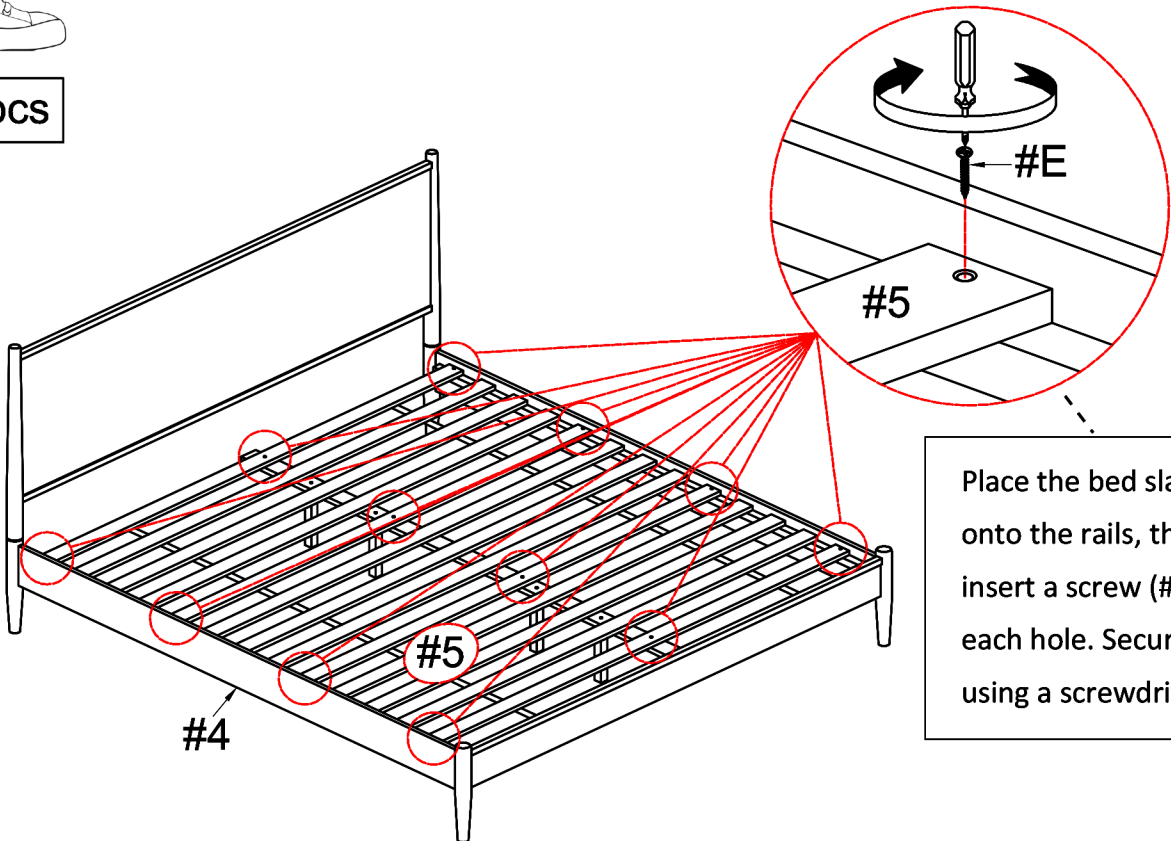

Place the bed slats (#5) onto the rails, then insert a screw (#E) into each hole. Secure using a screwdriver.



#5

#A x 10pcs
#B x 10pcs
#F x 10pcs

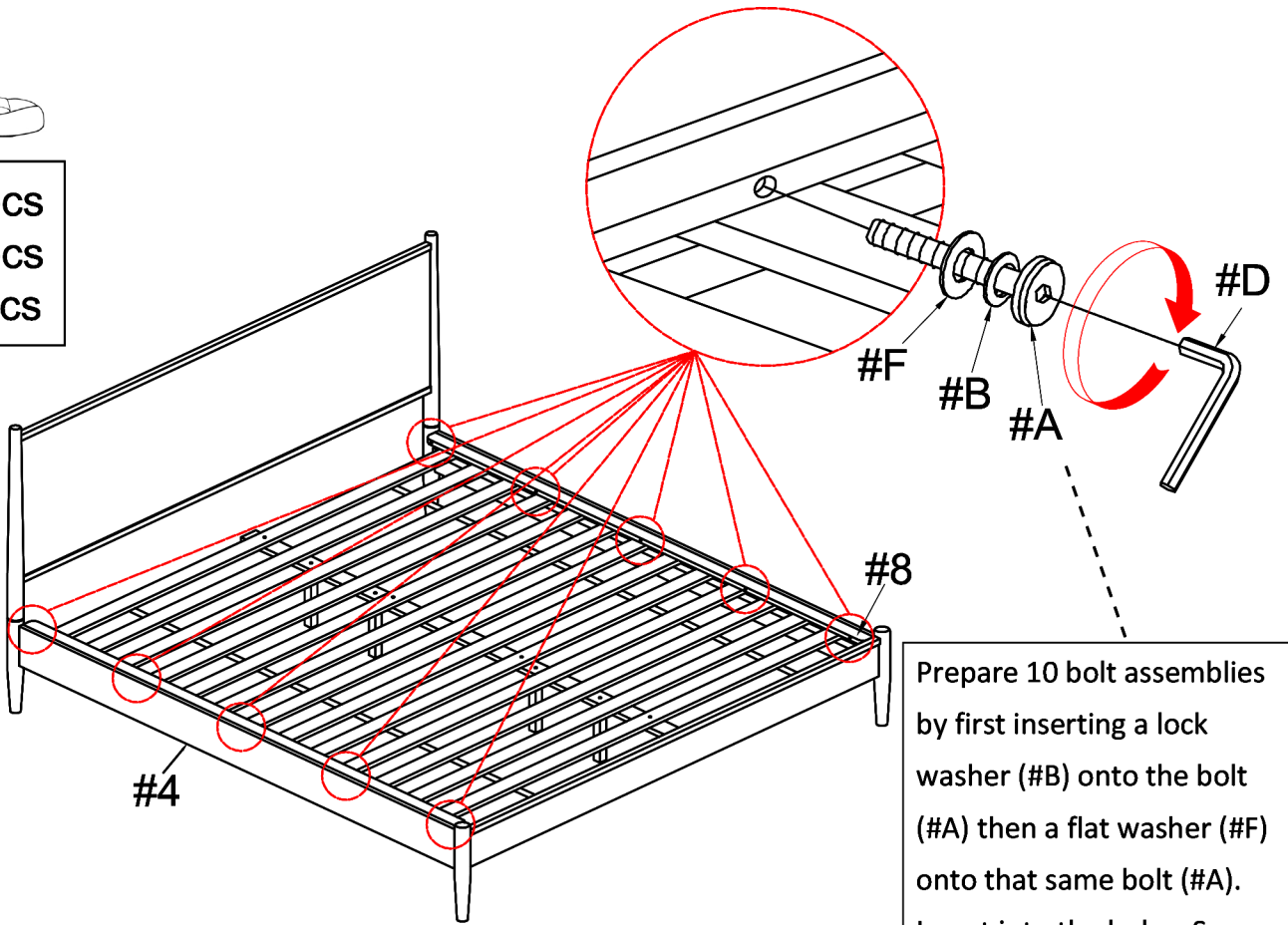

Prepare 10 bolt assemblies by first inserting a lock washer (#B) onto the bolt (#A) then a flat washer (#F) onto that same bolt (#A). Insert into the holes. Secure.



#6

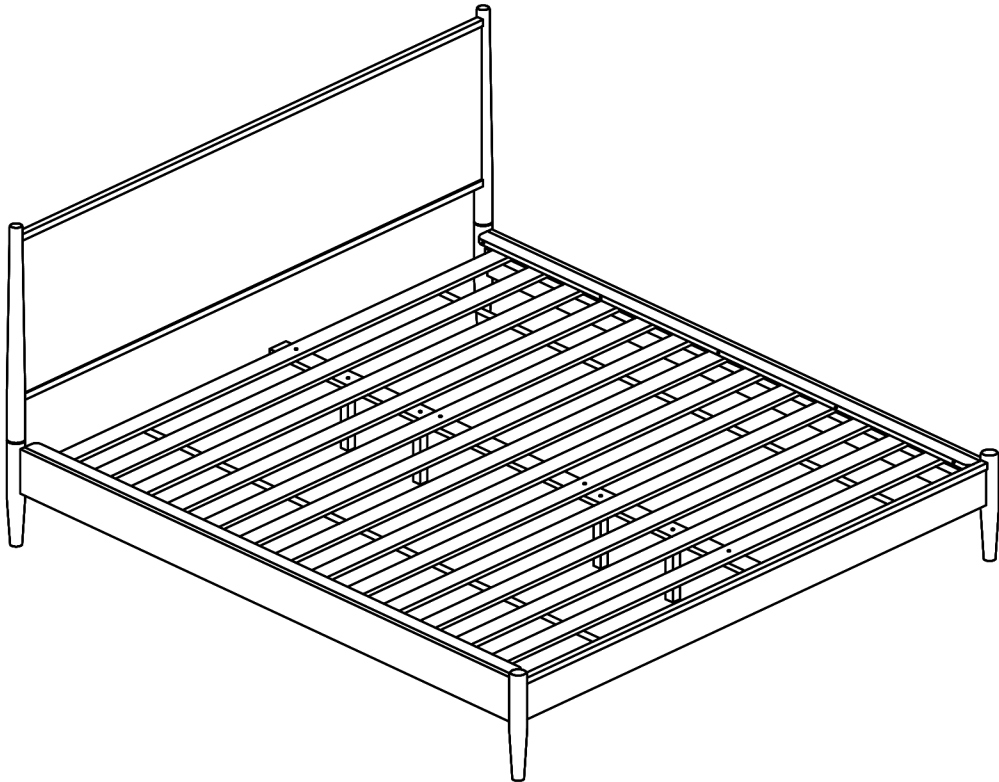

ASSEMBLY IS COMPLETED

Assembly Instructions

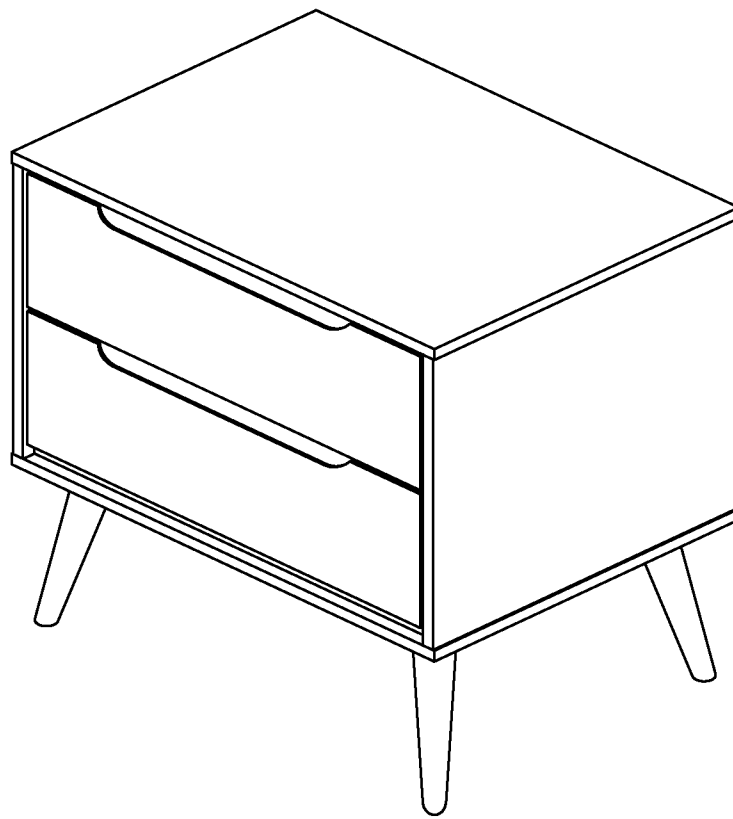

ASSEMBLY RATING

The Assembly Rating is a 5-point system that shows the degree of effort needed in assembling a specific product (with 1 being easy and 5 being difficult). For some products, two persons are recommended.

EASY  DIFFICULT

Tools Required For Assembly:

Allen Wrench

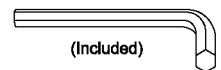

2 PERSONS RECOMMENDED

ASSEMBLY & CARE ADVICE

FOR YOUR FURNITURE TO LAST, CORRECT ASSEMBLY AND PROPER MAINTENANCE ARE NECESSARY. PLEASE FOLLOW THE INFORMATION PROVIDED BELOW TO FULLY ENJOY YOUR FURNITURE.

BASIC ASSEMBLY TECHNIQUES

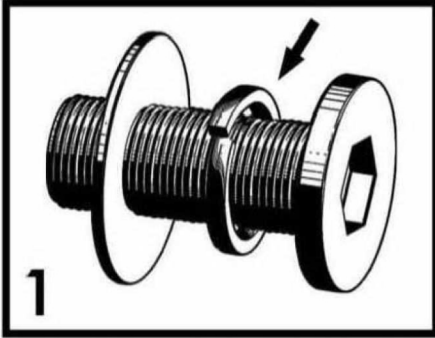

When lock or spring washer is used in an assembly, please make sure the lock or spring washer is placed between the larger flat washer and the head of the screw or bolt.

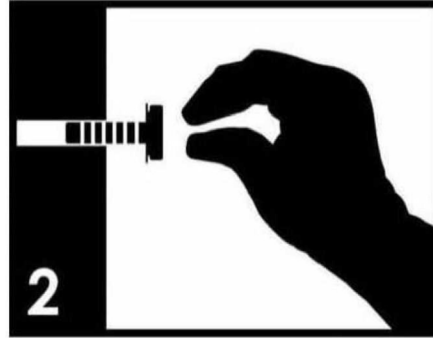

Position each part correctly and insert screws or bolts into their respective holes by hand tighten or using the proper hand tool. Only tighten when step is completed or when instructed to do so.

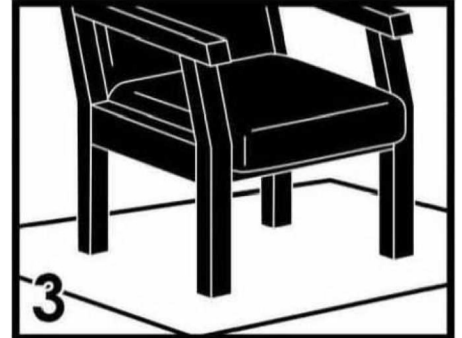

Use cardboard or carpet area when assembling furniture to prevent scratches. Make sure the furniture rests on a flat and level surface with each leg evenly touching the floor.

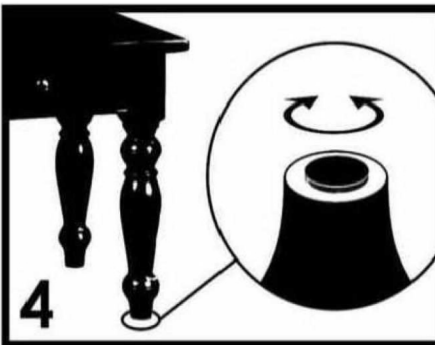

Some furniture comes with height adjustment knobs underneath each leg. To lower or to raise each leg, you need to turn clockwise or counterclockwise, respectively.

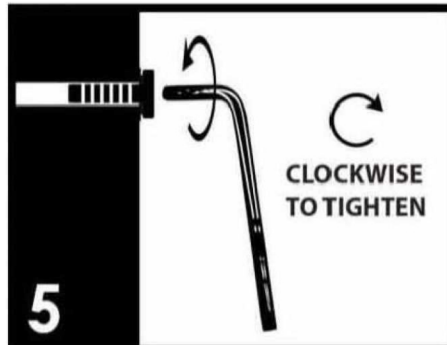

Make sure all parts are properly aligned, then use the appropriate hand tool to completely tighten the bolts or screws. Do not use power tools and do not overtighten.

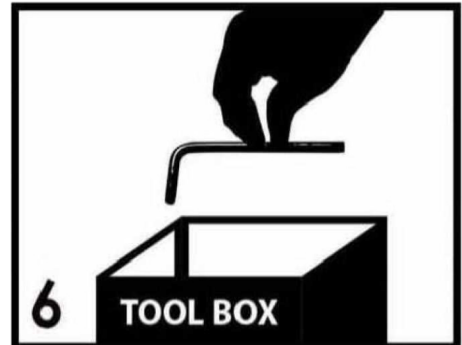

Save the instructions and store the Allen wrench or any supplied tool for later maintenance. After two weeks, check and tighten any loose hardware and repeat again every six months thereafter.

IT IS THE USER'S RESPONSIBILITY TO MAINTAIN THE FURNITURE. THE HARDWARE MAY LOOSEN OVER TIME AND MAY CAUSE THE FURNITURE TO BE WOBBLY AND UNABLE TO SUPPORT ITS INTENDED WEIGHT CAPACITY. THIS MAY LEAD TO COLLAPSE AND MAY CAUSE SERIOUS INJURY.



FAILURE TO FOLLOW THE GUIDELINES ABOVE MAY RESULT IN INJURY AND/OR PROPERTY DAMAGE.

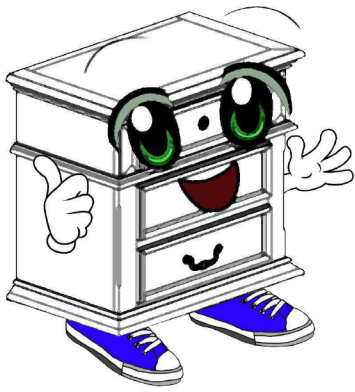

Before you begin, please read Page 2 of "Assembly and Care Advice".

And remember, do not tighten until each step is completed or instructed.

Parts List

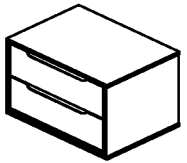

#1 x 1pc
Nightstand

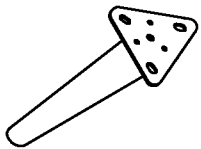

#2 x 4pcs
Leg

Hardware List



#A x 12pcs
Bolt Ø5/16"x 7/8"



#B x 12pcs
Lock washer Ø5/16"



#C x 12pcs
Flat washer Ø5/16"



#D x 1pc
Allen wrench M4



#1

#A x 12pcs
#B x 12pcs
#C x 12pcs

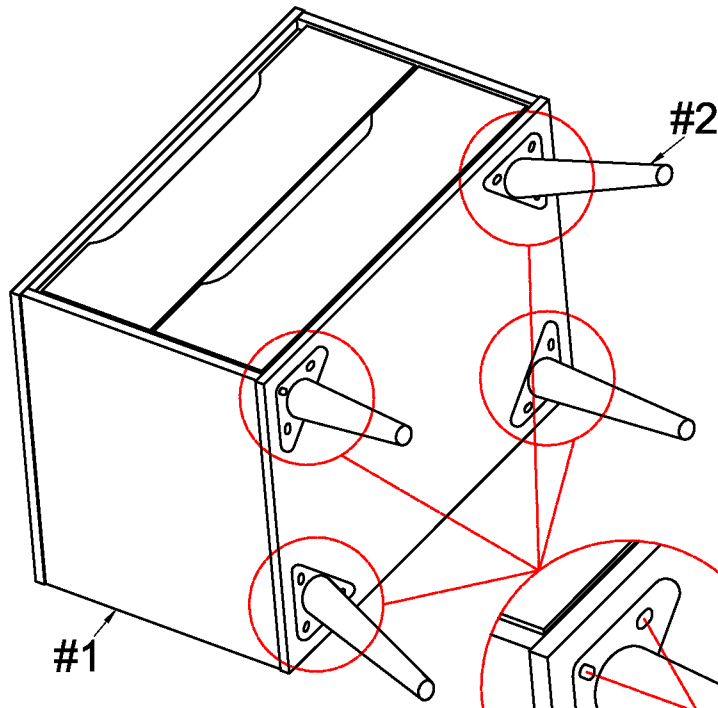

1. Prepare 12 bolt assemblies by first inserting a lock washer (#B) onto the bolt (#A) then a flat washer (#C) onto that same bolt (#A).

2. Align the legs (#2) to the holes along the bottom of the night stand (#1), then insert the bolt assemblies. Secure using the Allen wrench (#D).



#2

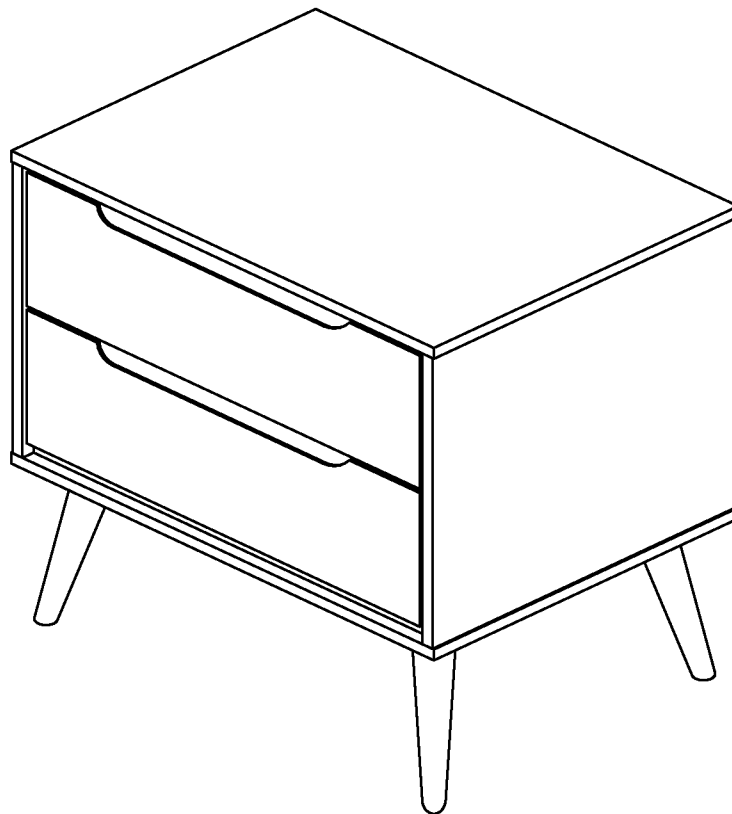

ASSEMBLY IS COMPLETED

Assembly Instructions

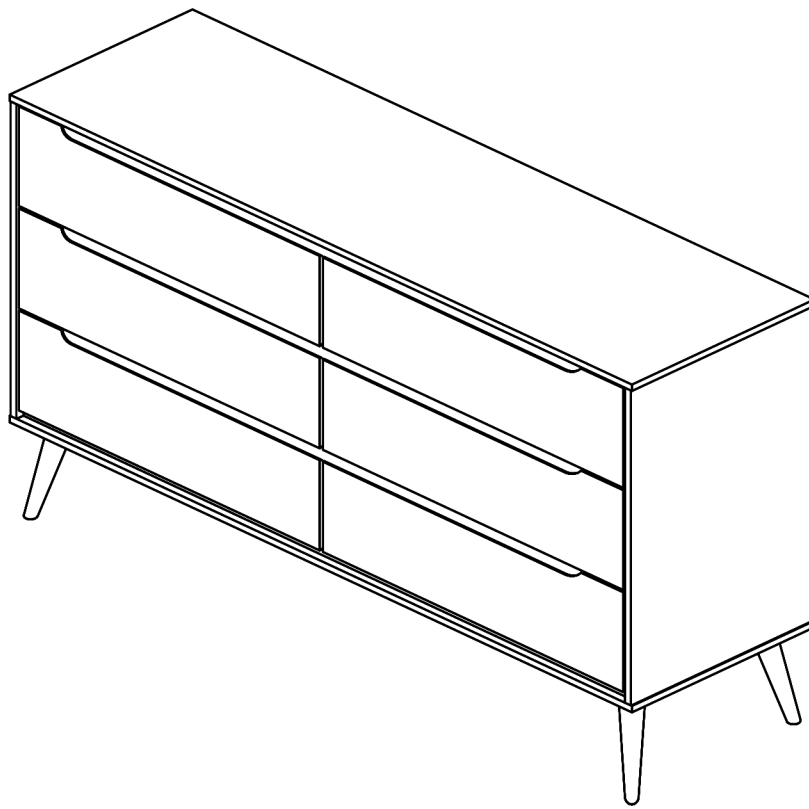

ASSEMBLY RATING

The Assembly Rating is a 5-point system that shows the degree of effort needed in assembling a specific product (with 1 being easy and 5 being difficult). For some products, two persons are recommended.

Tools Required For Assembly:

Allen Wrench

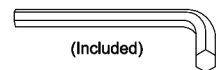

EASY



DIFFICULT



2 PERSONS RECOMMENDED

ASSEMBLY & CARE ADVICE

FOR YOUR FURNITURE TO LAST, CORRECT ASSEMBLY AND PROPER MAINTENANCE ARE NECESSARY. PLEASE FOLLOW THE INFORMATION PROVIDED BELOW TO FULLY ENJOY YOUR FURNITURE.

BASIC ASSEMBLY TECHNIQUES

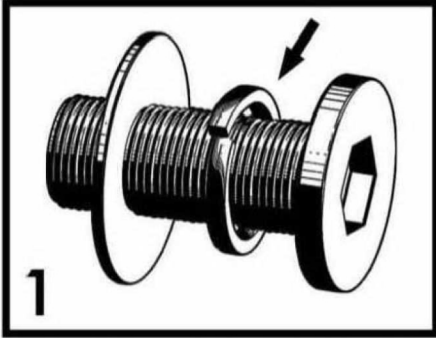

When lock or spring washer is used in an assembly, please make sure the lock or spring washer is placed between the larger flat washer and the head of the screw or bolt.

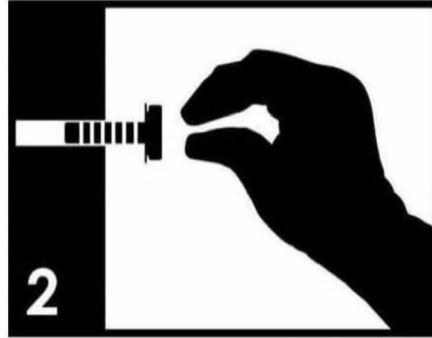

Position each part correctly and insert screws or bolts into their respective holes by hand tighten or using the proper hand tool. Only tighten when step is completed or when instructed to do so.

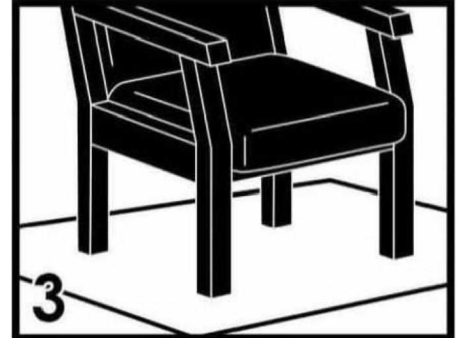

Use cardboard or carpet area when assembling furniture to prevent scratches. Make sure the furniture rests on a flat and level surface with each leg evenly touching the floor.

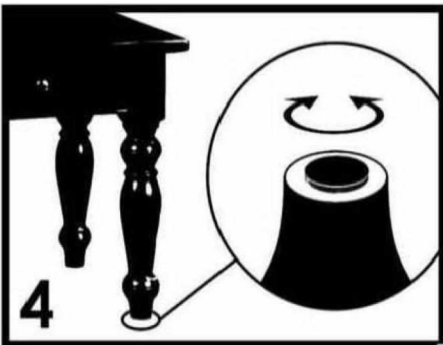

Some furniture comes with height adjustment knobs underneath each leg. To lower or to raise each leg, you need to turn clockwise or counterclockwise, respectively.

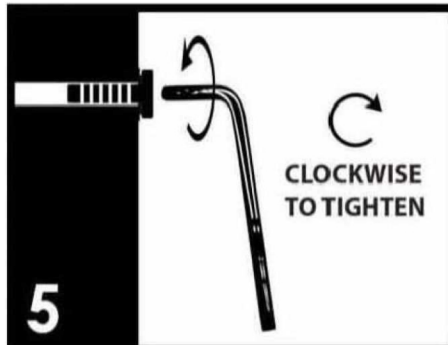

Make sure all parts are properly aligned, then use the appropriate hand tool to completely tighten the bolts or screws. Do not use power tools and do not overtighten.

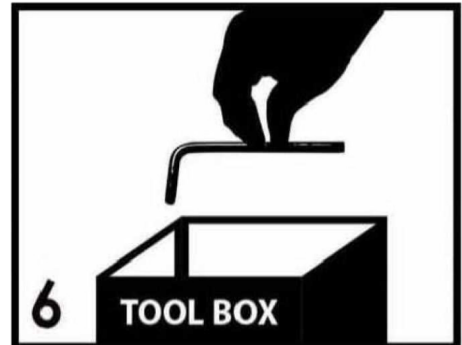

Save the instructions and store the Allen wrench or any supplied tool for later maintenance. After two weeks, check and tighten any loose hardware and repeat again every six months thereafter.

IT IS THE USER'S RESPONSIBILITY TO MAINTAIN THE FURNITURE. THE HARDWARE MAY LOOSEN OVER TIME AND MAY CAUSE THE FURNITURE TO BE WOBBLY AND UNABLE TO SUPPORT ITS INTENDED WEIGHT CAPACITY. THIS MAY LEAD TO COLLAPSE AND MAY CAUSE SERIOUS INJURY.



FAILURE TO FOLLOW THE GUIDELINES ABOVE MAY RESULT IN INJURY AND/OR PROPERTY DAMAGE.

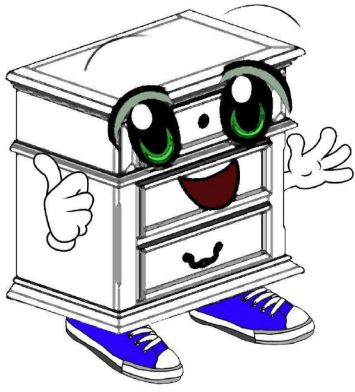

Before you begin, please read Page 2 of "Assembly and Care Advice".

And remember, do not tighten until each step is completed or instructed.

Parts List

Hardware List

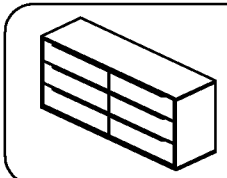

#1 x 1pc
Dresser



#A x 12pcs
Bolt $\text{Ø}5/16$ "x 7/8"

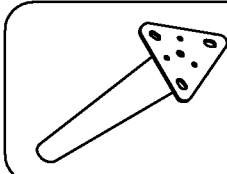

#2 x 4pcs
Leg



#B x 12pcs
Lock washer $\text{Ø}5/16$ "

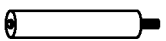

#3 x 1pc $\text{Ø}5/16$ "
Support Leg (185x $\text{Ø}30$ mm)



#C x 12pcs
Flat washer $\text{Ø}5/16$ "



#D x 1pc
Allen wrench M4



#1

#A x 12pcs
#B x 12pcs
#C x 12pcs

3. Insert the support leg (#3) into the center hole, turn right to tighten.

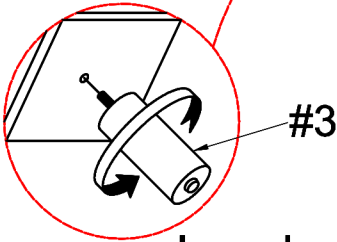

Level

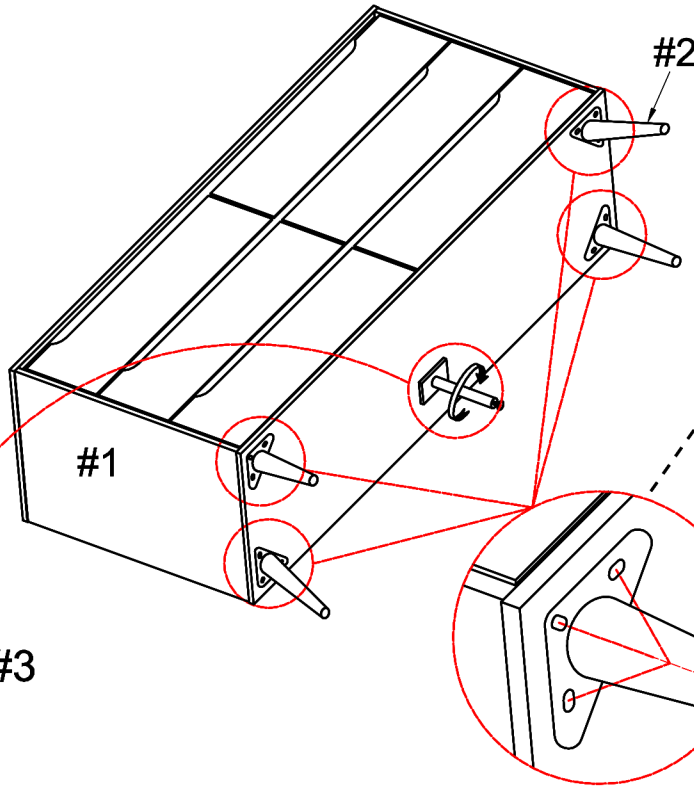

1. Prepare 12 bolt assemblies by first inserting a lock washer (#B) onto the bolt (#A) then a flat washer (#C) onto that same bolt (#A).
2. Align the legs (#2) to the holes along the bottom of the dresser (#1), then insert the bolt assemblies. Secure using the Allen wrench (#D).



#2

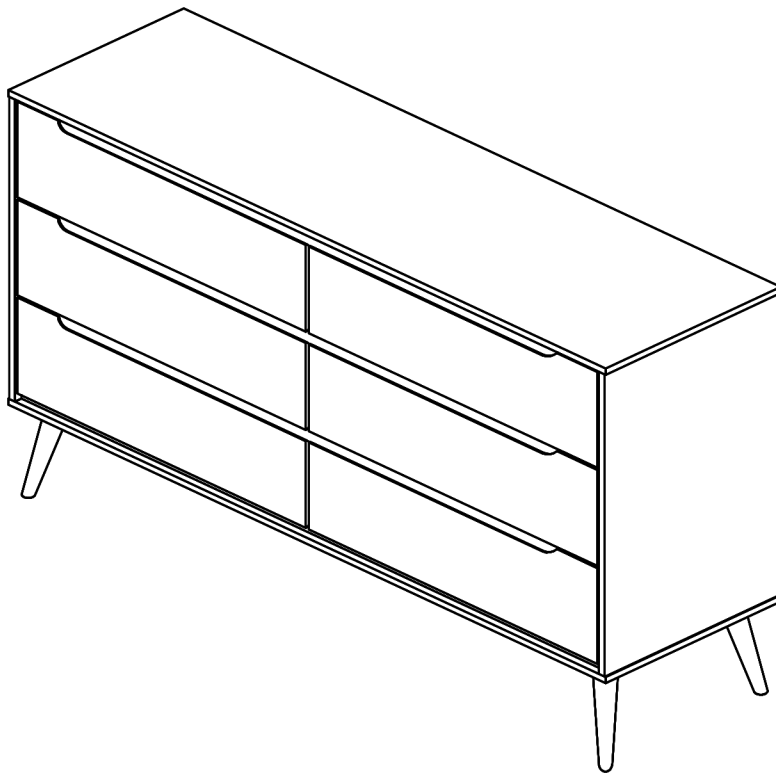

ASSEMBLY IS COMPLETED

Assembly Instructions

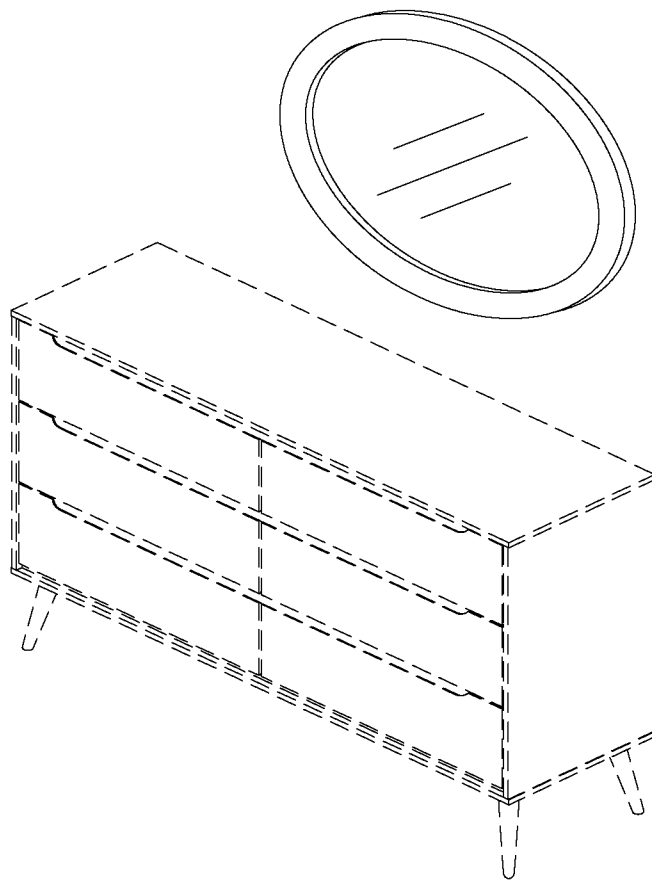

ASSEMBLY RATING

The Assembly Rating is a 5-point system that shows the degree of effort needed in assembling a specific product (with 1 being easy and 5 being difficult). For some products, two persons are recommended.

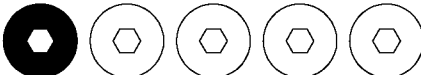
EASY  DIFFICULT

Tools Required For Assembly:

Phillips Screwdriver



(Not Included)



2 PERSONS RECOMMENDED

ASSEMBLY & CARE ADVICE

FOR YOUR FURNITURE TO LAST, CORRECT ASSEMBLY AND PROPER MAINTENANCE ARE NECESSARY. PLEASE FOLLOW THE INFORMATION PROVIDED BELOW TO FULLY ENJOY YOUR FURNITURE.

BASIC ASSEMBLY TECHNIQUES

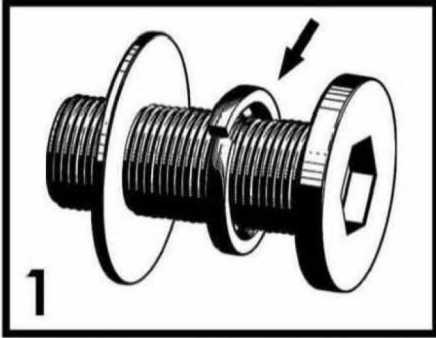

1
When lock or spring washer is used in an assembly, please make sure the lock or spring washer is placed between the larger flat washer and the head of the screw or bolt.

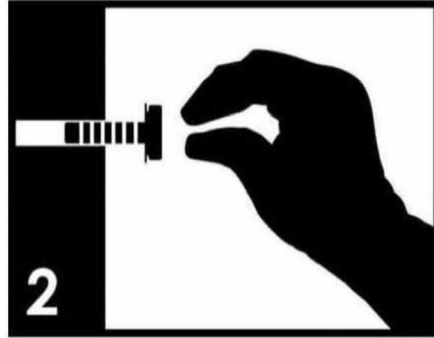

2
Position each part correctly and insert screws or bolts into their respective holes by hand tighten or using the proper hand tool. Only tighten when step is completed or when instructed to do so.

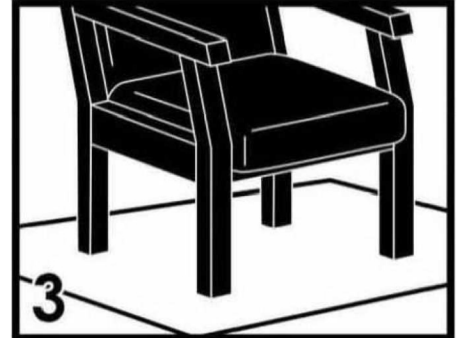

3
Use cardboard or carpet area when assembling furniture to prevent scratches. Make sure the furniture rests on a flat and level surface with each leg evenly touching the floor.

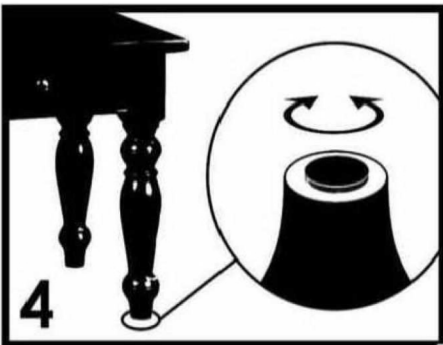

4
Some furniture comes with height adjustment knobs underneath each leg. To lower or to raise each leg, you need to turn clockwise or counterclockwise, respectively.

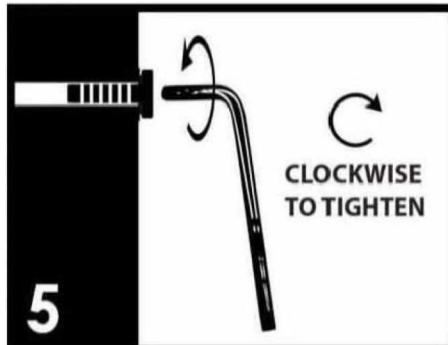

5
Make sure all parts are properly aligned, then use the appropriate hand tool to completely tighten the bolts or screws. Do not use power tools and do not overtighten.

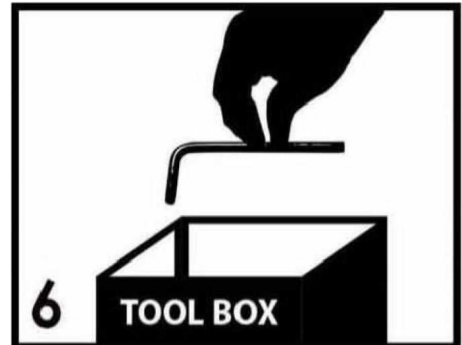

6
Save the instructions and store the Allen wrench or any supplied tool for later maintenance. After two weeks, check and tighten any loose hardware and repeat again every six months thereafter.

IT IS THE USER'S RESPONSIBILITY TO MAINTAIN THE FURNITURE. THE HARDWARE MAY LOOSEN OVER TIME AND MAY CAUSE THE FURNITURE TO BE WOBBLY AND UNABLE TO SUPPORT ITS INTENDED WEIGHT CAPACITY. THIS MAY LEAD TO COLLAPSE AND MAY CAUSE SERIOUS INJURY.



FAILURE TO FOLLOW THE GUIDELINES ABOVE MAY RESULT IN INJURY AND/OR PROPERTY DAMAGE.

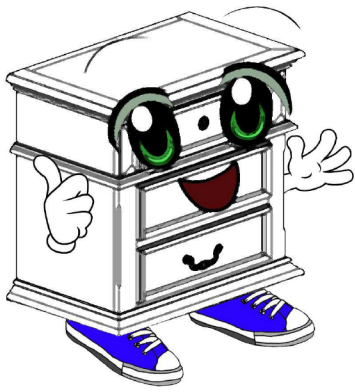

Before you begin, please read Page 2 of "Assembly and Care Advice".

And remember, do not tighten until each step is completed or instructed.

Parts List

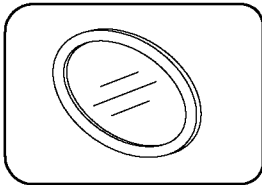

#1 x 1pc
Mirror

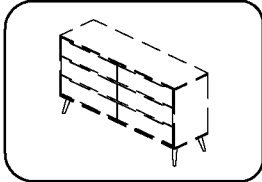

#2 x 1pc
Dresser

Hardware List

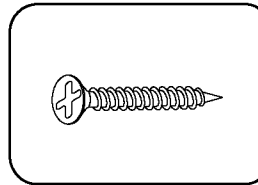

#A x 2pcs
Screw Ø4x1-3/16"

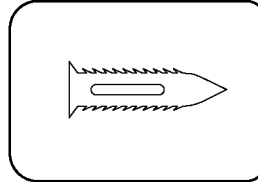

#B x 2pcs
Plastic anchor



#1

#A x 2pcs
#B x 2pcs

1. Drill a hole slightly smaller than the plastic anchor (#B) into the wall, then insert the anchor until fully secured.
2. Insert the screw (#A) and secure.

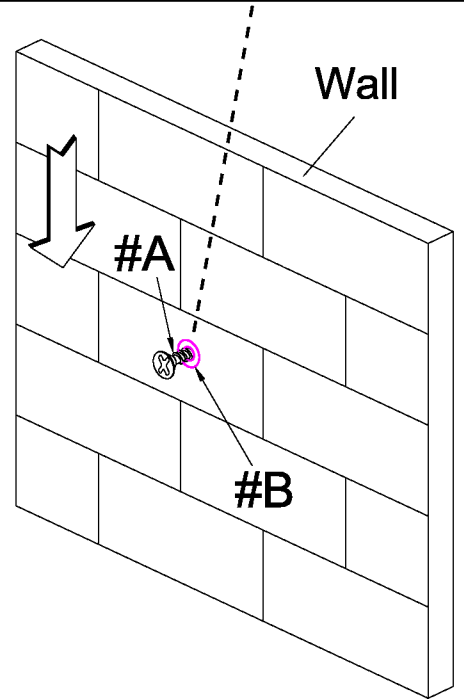
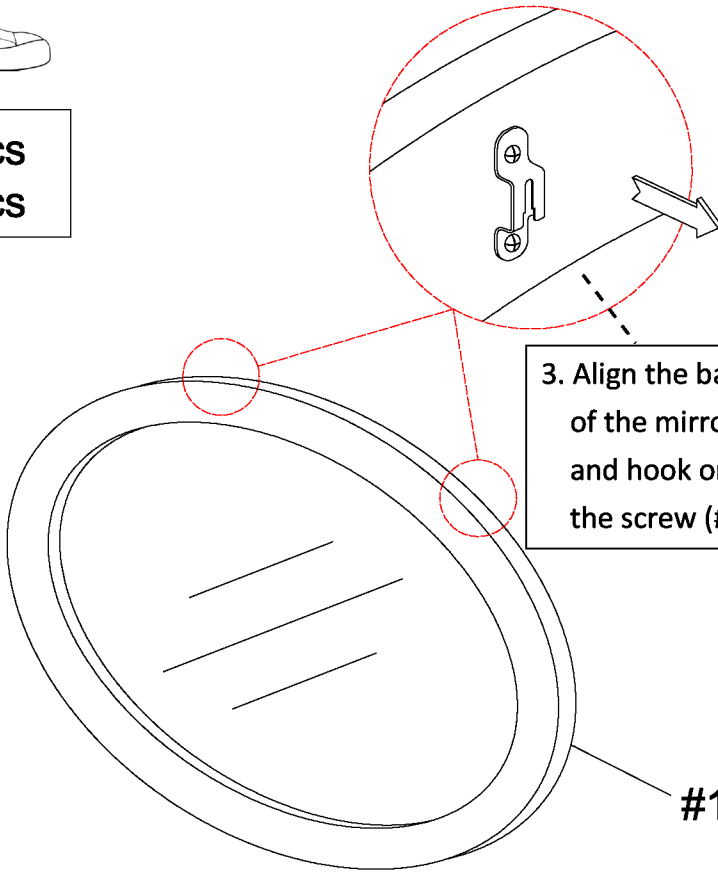

#2

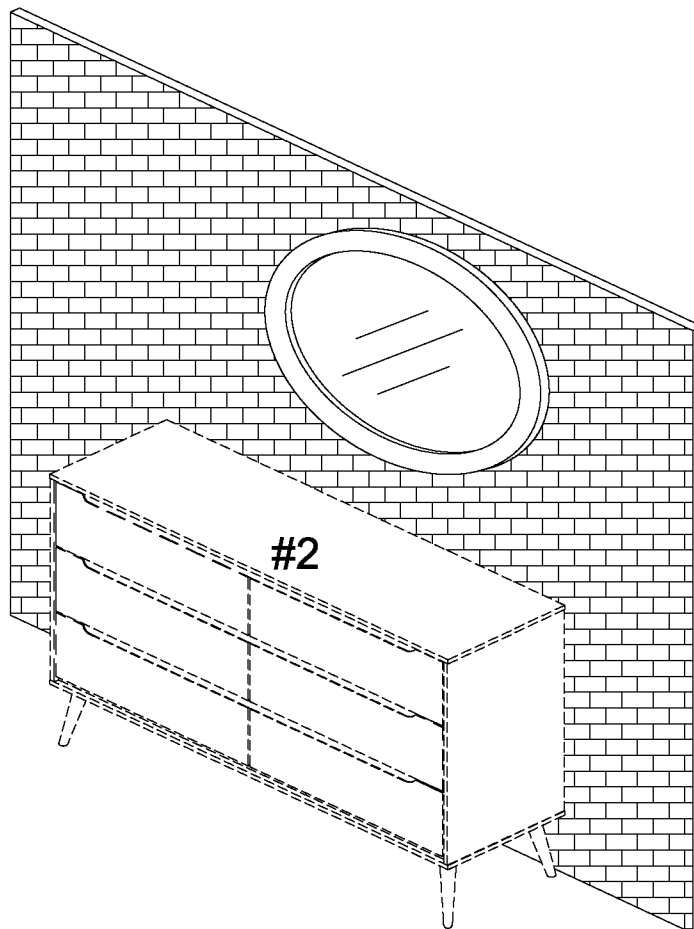

ASSEMBLY IS COMPLETED