

# ASSEMBLY INSTRUCTIONS

---

## TOOLS REQUIRED

No Tools Required For Assembly

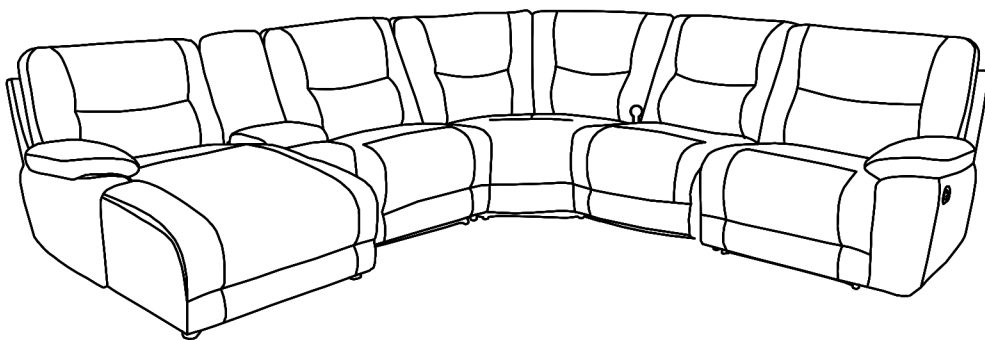

**2 - People  
Recommended**

## ASSEMBLY RATING



EASY —————> DIFFICULT

The Assembly Rating is a 5-point system showing the level of effort needed to assemble a specific product.



## **CHECK BEFORE STARTING**

### **Are you missing anything?**

Double-check all parts, hardware and accessories listed on Page 6 are accounted for.

### **Check out our Quick Tips!**

We recommend reviewing the pre-assembly handouts. Even experts need a refresher now and then!

### **Should we send any replacements?**

Are there any irregularities or flaws in the parts? We can send replacements!

### **Prep Time!**

Please review the assembly instructions and all diagrams prior to assembling. Arrange parts as recommended on Page 7 and group identical hardware together to make assembling easier.

# PRE ASSEMBLY INTRODUCTION

We understand building ready-to-assemble furniture can be a challenging experience for some. To help avoid confusion, we have provided some helpful tips that may speed up the process.

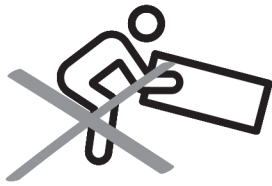

## Teamwork

ALWAYS have at least two people to help with transporting and assembling the product to avoid potential injury and/or damage.

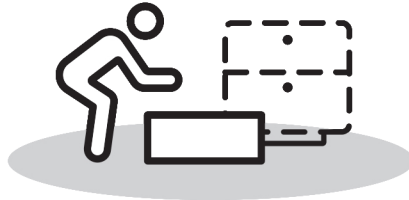
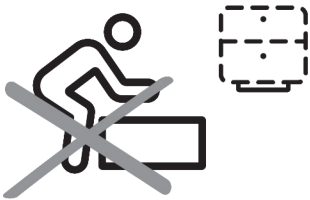

## Suitable Location

Assembling near the area of the intended location is highly recommended.



## Sufficient Space

Make sure you have enough space to move around during the assembly.



## Avoid Scratches

Use cardboard, blankets or a carpeted area while assembling furniture to prevent scratches.

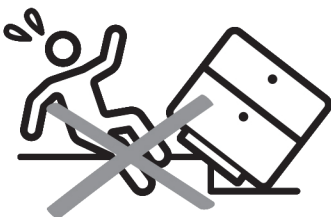

## Flat Surface

Make sure the furniture rests on a flat and level surface with each leg evenly touching the floor.

# ASSEMBLY AND CARE ADVICE



**FAILURE TO FOLLOW THE GUIDELINES BELOW MAY RESULT IN INJURY AND/OR PROPERTY DAMAGE.**



Position each part correctly and insert screws or bolts into their respective holes.



Turn clockwise to tighten and only tighten when step is completed or when instructed to do so.



Use the appropriate hand tools or power tools for assembly. Select steps, such as tightening screws and/or bolts, may require hand tools to avoid causing damage during assembly.



Save the instructions and store any supplied tools for later maintenance.



After two weeks, check and tighten any loose hardware and repeat again every six months thereafter.

**IT IS THE USER'S RESPONSIBILITY TO MAINTAIN THE FURNITURE. THE HARDWARE MAY LOOSEN OVER TIME AND MAY CAUSE THE FURNITURE TO BE WOBBLY AND UNABLE TO SUPPORT ITS INTENDED WEIGHT CAPACITY. THIS MAY LEAD TO COLLAPSE AND MAY CAUSE SERIOUS INJURY.**

# CORNER SOFA

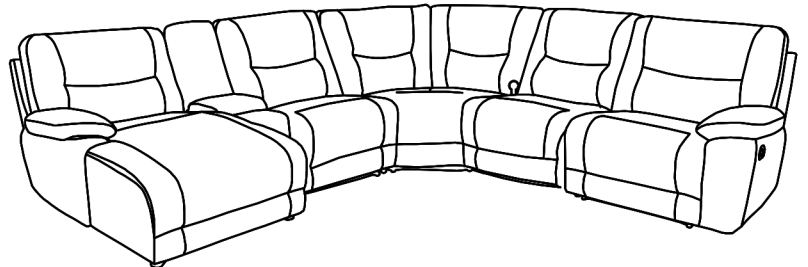
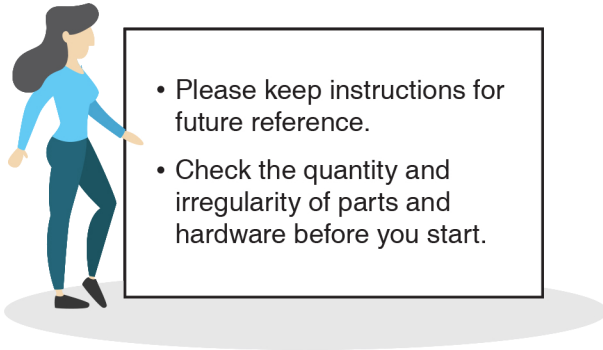

## PARTS

#1 1pc

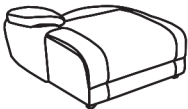

Left Chaise

#2 1pc

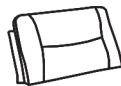

Left Chaise  
Back cushion

#3 1pc

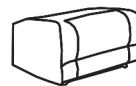

Armless  
Chair Seat

#4 1pc



Armless Chair  
Back cushion

#5 1pc



Corne Sofa Seat

#6 2pcs

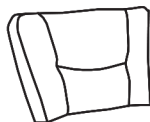

Corne Sofa Back cushion(L&R)

#7 1pc



Console

#8 1pc



Console Back  
Cushion

#9 1pc

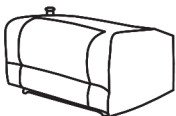

Reclining Armless  
Chair Seat

#10 1pc

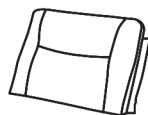

Reclining Armless Chair  
Back cushion

#11 1pc

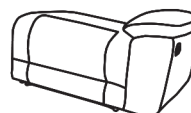

Right Recliner  
Chair

#12 1pc

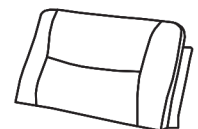









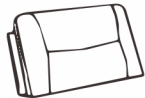

Right Recliner Chair  
Back cushion

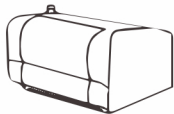
#13 2pcs

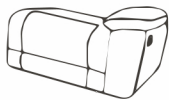

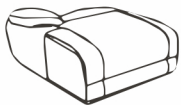
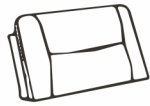
Left Chaise Chair Leg

Carton	Designation	Part		Hardware
	Armless Chair			
	Console			
	Corner			
	Reclining Armless Chair			
	Right Recliner Chair			
	Left Chaise			

# ASSEMBLY INSTRUCTIONS

- 1** Part #1 x1pc  
Part #2 x1pc  
Part #13 x2pcs

Align and attach the metal brackets of the back (#2) to the seat (#1).

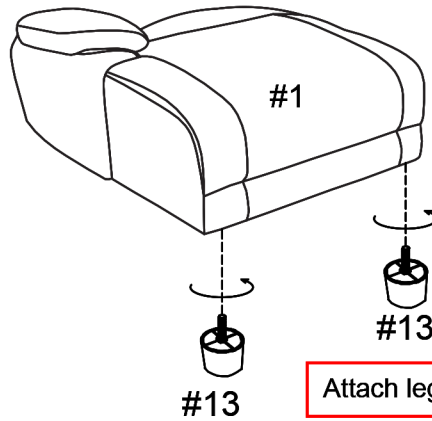
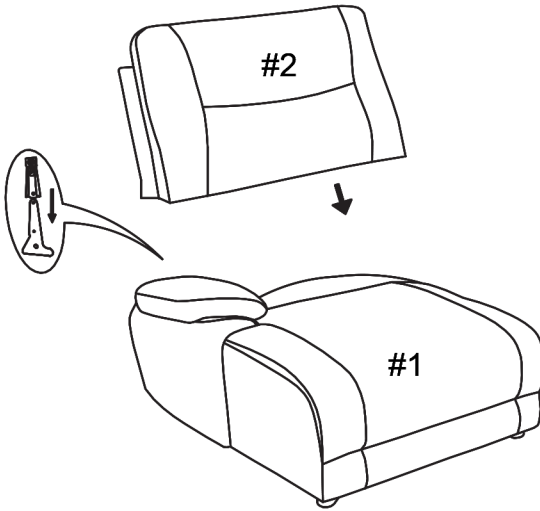

Attach legs (#13) to Left Chaise (#1).

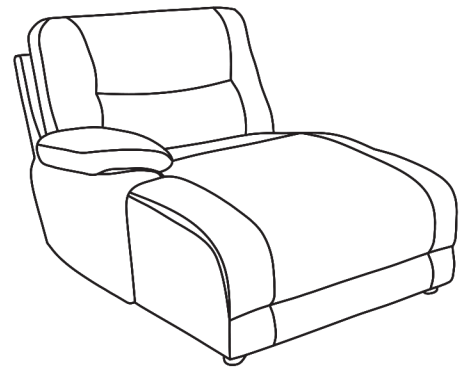

- 2** Part #3 x1pc  
Part #4 x1pc

Align and attach the metal brackets of the back (#4) to the seat (#3).

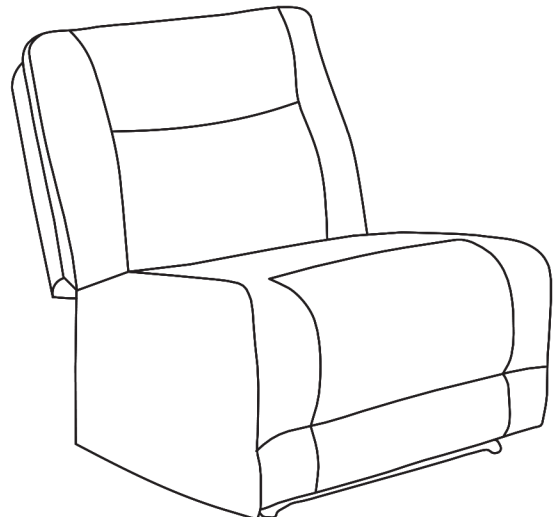
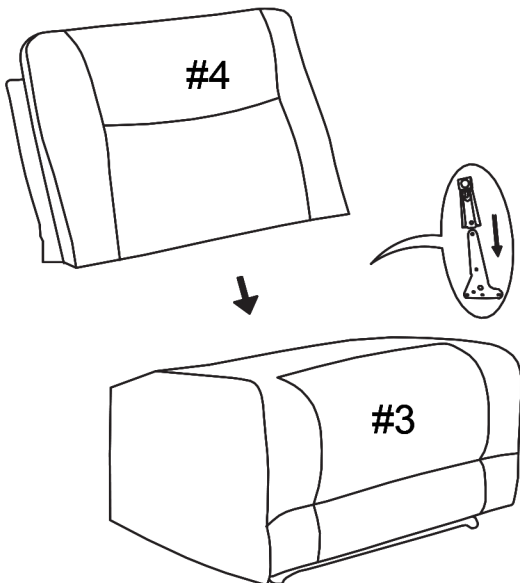

# ASSEMBLY INSTRUCTIONS

**3** Part #5 x 1pc  
Part #6 x 2pcs

Align and attach the metal brackets of the backs (#6R/L) to the seat (#5)

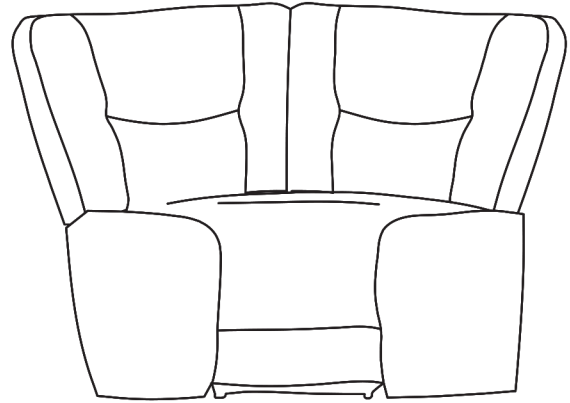
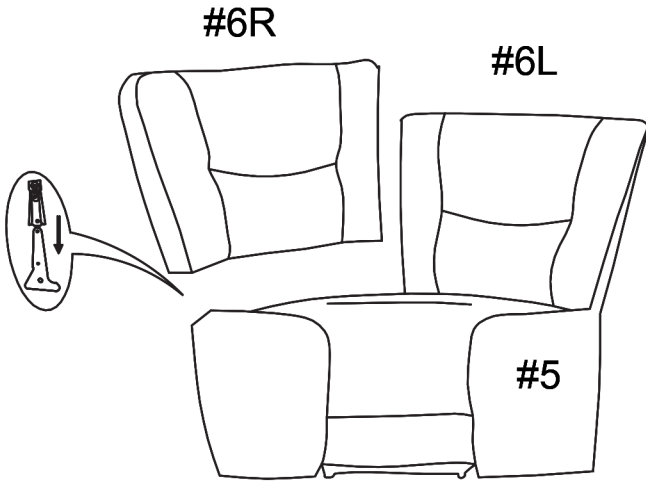

**4** Part #7 x 1pc  
Part #8 x 1pc

Align and attach the metal brackets of the back (#8) to the console (#7).

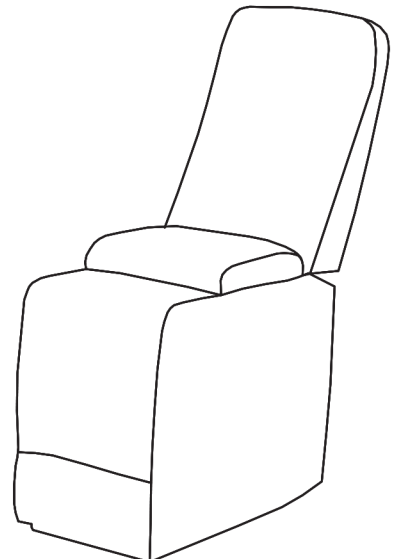
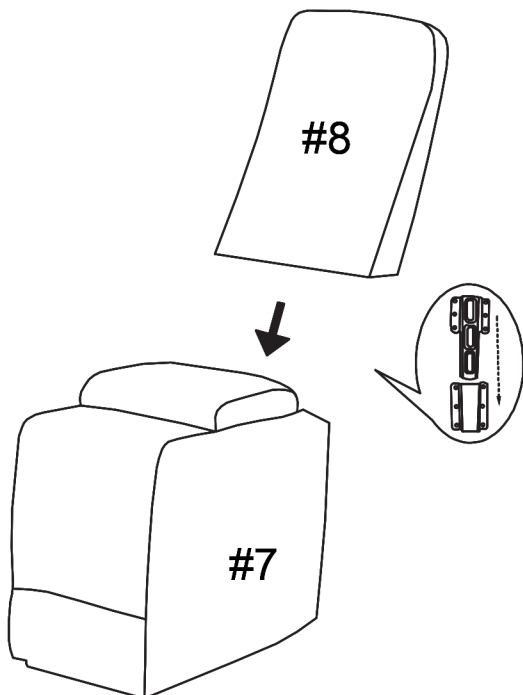

# ASSEMBLY INSTRUCTIONS

5 Part #9 x 1pc  
Part #10 x 1pc

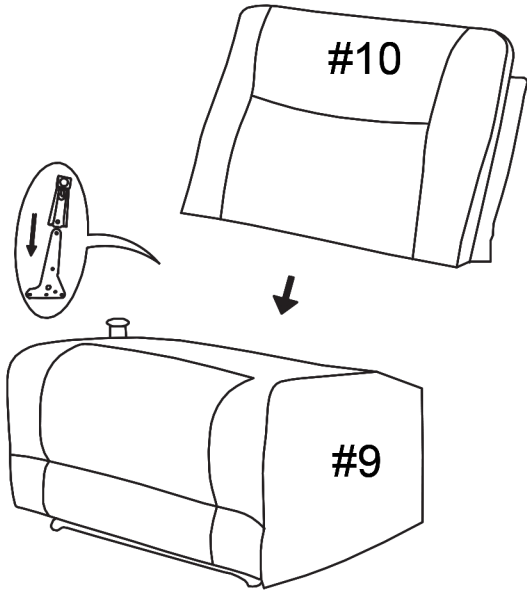

Align and attach the metal brackets of the back (#10) to the seat (#9).

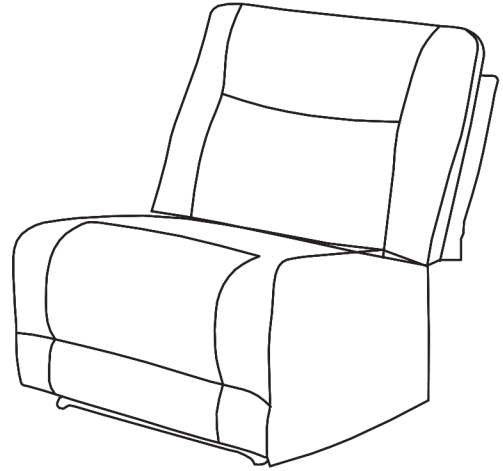

6 Part #11 x 1pc  
Part #12 x 1pc

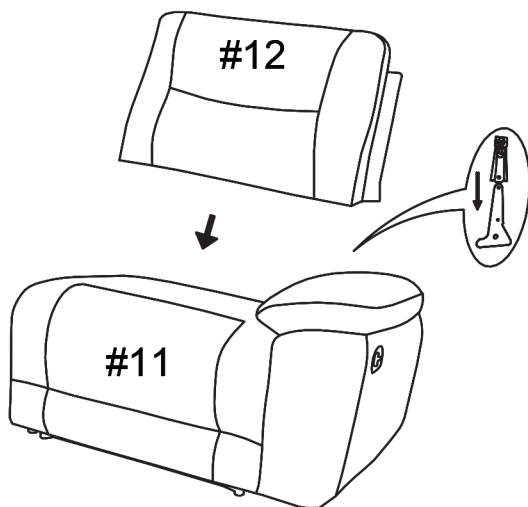

Align and attach the metal brackets of the back (#12) to the seat (#11).

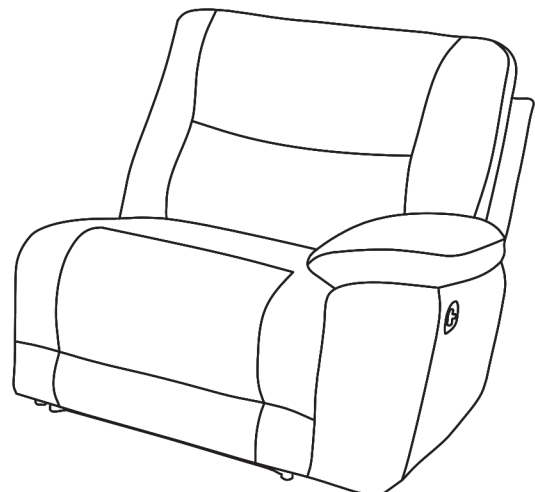

# ASSEMBLY INSTRUCTIONS

# 7

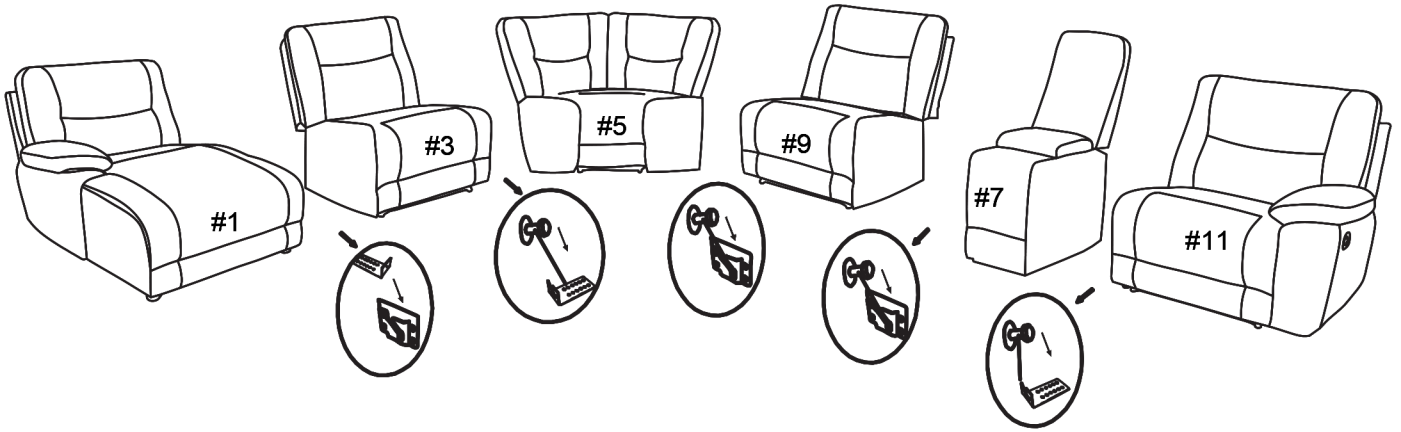

# 8

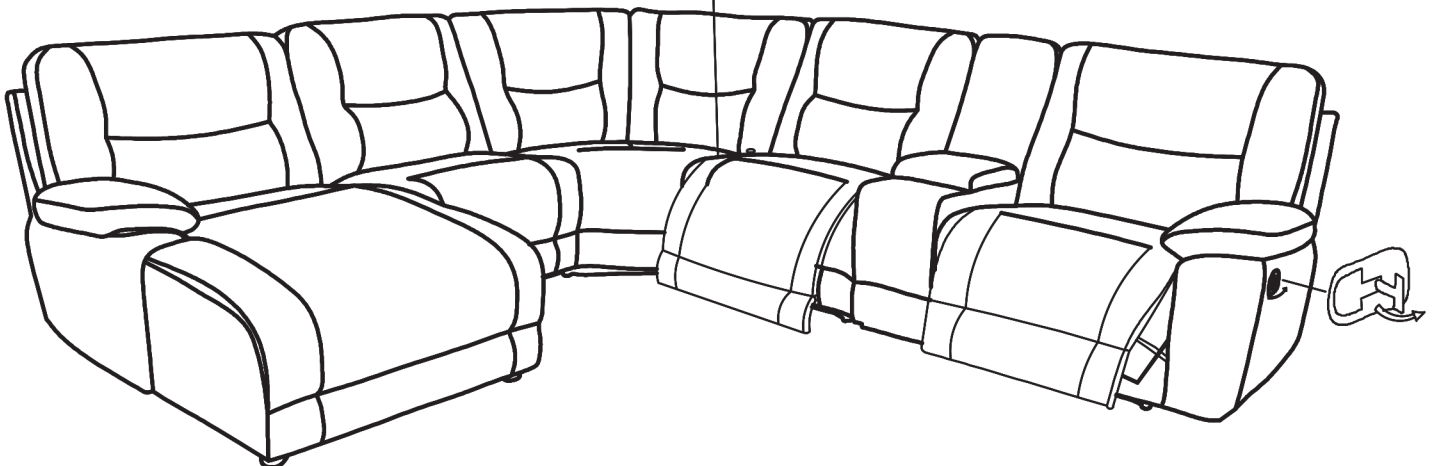
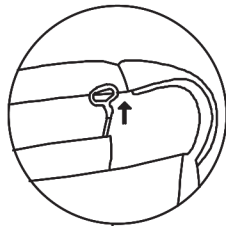

## ASSEMBLY COMPLETED



Please ensure the furniture rests on an even and flat surface. If the product wobbles or feels loose, double-check all bolts and/or screws are properly tightened and secured.



### Keep this handy!

Please retain this instruction manual and any order-related information for future reference.



### Lift, don't drag!

To avoid damage to product please always LIFT the product when transporting or adjusting the placement.