

Assembly Instructions

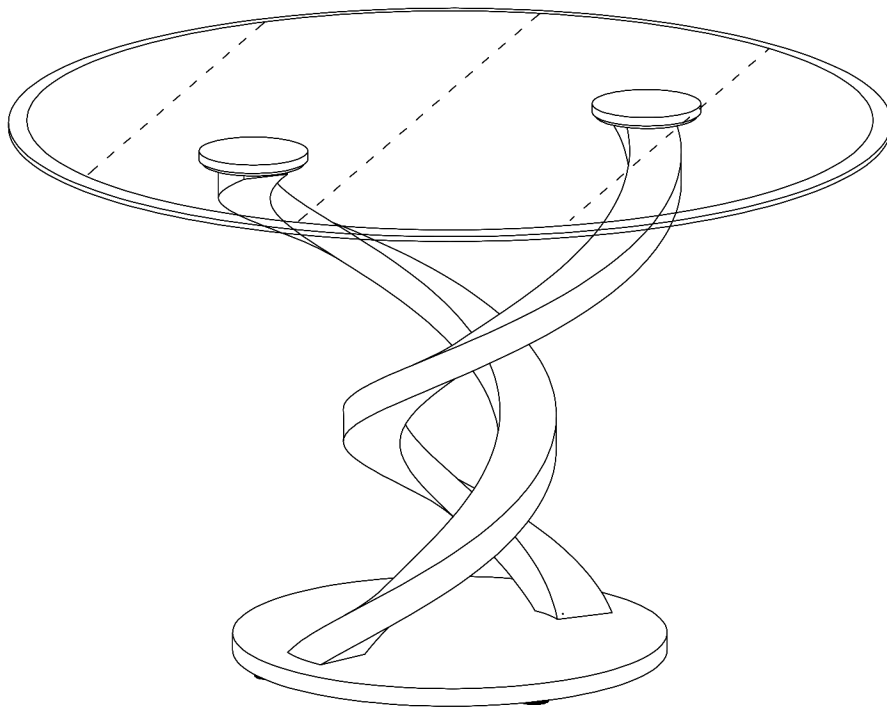

ASSEMBLY RATING

The Assembly Rating is a 5-point system that shows the degree of effort needed in assembling a specific product (with 1 being easy and 5 being difficult). For some products, two persons are recommended.

Tools Required For Assembly:

Allen Wrench

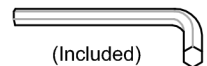

EASY



DIFFICULT



2 PERSONS RECOMMENDED

ASSEMBLY & CARE ADVICE

FOR YOUR FURNITURE TO LAST, CORRECT ASSEMBLY AND PROPER MAINTENANCE ARE NECESSARY. PLEASE FOLLOW THE INFORMATION PROVIDED BELOW TO FULLY ENJOY YOUR FURNITURE.

BASIC ASSEMBLY TECHNIQUES

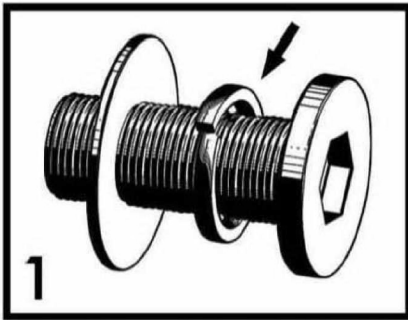

When lock or spring washer is used in an assembly, please make sure the lock or spring washer is placed between the larger flat washer and the head of the screw or bolt.

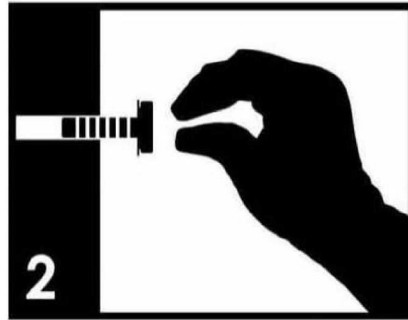

Position each part correctly and insert screws or bolts into their respective holes by hand tighten or using the proper hand tool. Only tighten when step is completed or when instructed to do so.

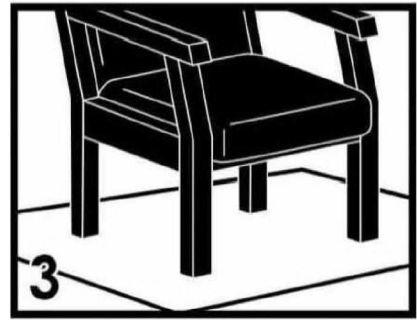

Use cardboard or carpet area when assembling furniture to prevent scratches. Make sure the furniture rests on a flat and level surface with each leg evenly touching the floor.

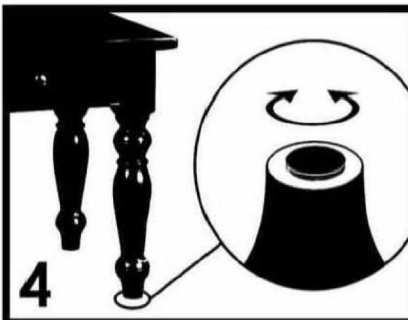

Some furniture comes with height adjustment knobs underneath each leg. To lower or to raise each leg, you need to turn clockwise or counterclockwise, respectively.

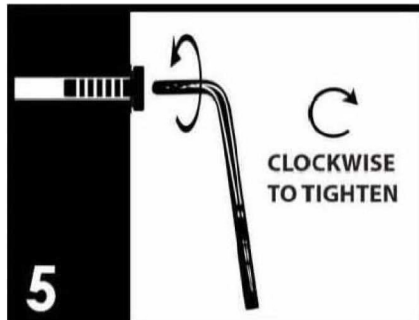

Make sure all parts are properly aligned, then use the appropriate hand tool to completely tighten the bolts or screws. Do not use power tools and do not overtighten.



Save the instructions and store the Allen wrench or any supplied tool for later maintenance. After two weeks, check and tighten any loose hardware and repeat again every six months thereafter.

IT IS THE USER'S RESPONSIBILITY TO MAINTAIN THE FURNITURE. THE HARDWARE MAY LOOSEN OVER TIME AND MAY CAUSE THE FURNITURE TO BE WOBBLY AND UNABLE TO SUPPORT ITS INTENDED WEIGHT CAPACITY. THIS MAY LEAD TO COLLAPSE AND MAY CAUSE SERIOUS INJURY.



FAILURE TO FOLLOW THE GUIDELINES ABOVE MAY RESULT IN INJURY AND/OR PROPERTY DAMAGE.

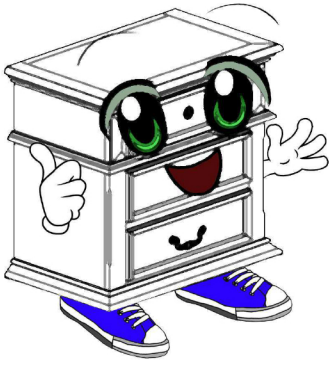

Before you begin, please read Page 2 of "Assembly and Care Advice".

And remember, do not tighten until each step is completed or instructed.

Parts List

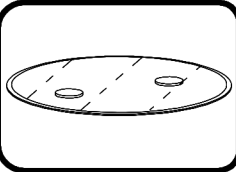

#1 x 1pc
Glass Top

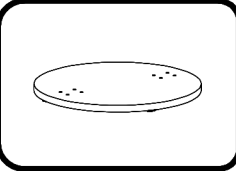

#2 x 1pc
Base

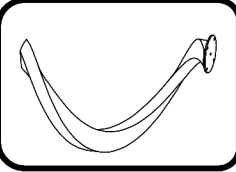

#3 x 2pcs
Support Leg

Hardware List

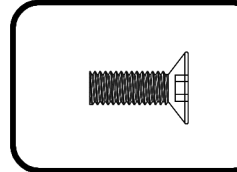

#A x 8pcs
Bolt $\varnothing 1/4$ "x1/2"

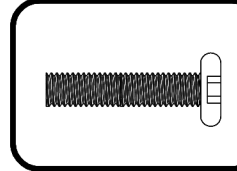

#B x 8pcs
Bolt $\varnothing 1/4$ "x1-1/4"

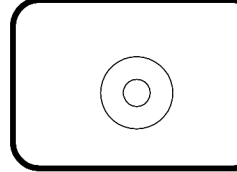

#C x 8pcs
Flat Washer

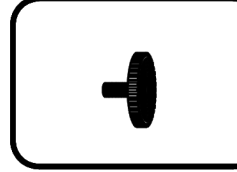

#D x 4pcs
Adjuster $\varnothing 1/4$ "x1/2"

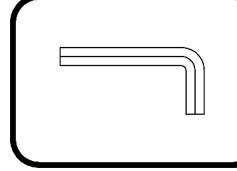

#E x 1pc
Allen Wrench M4



- I. Carefully place the glass top (#1) onto a protected surface.
- II. Align the two support legs (#3) to the pre-drilled holes on the glass top (#1) in a twisted motion.
- III. Insert 4 bolts (#A) and secure using the Allen wrench (#E).

#A x 8pcs

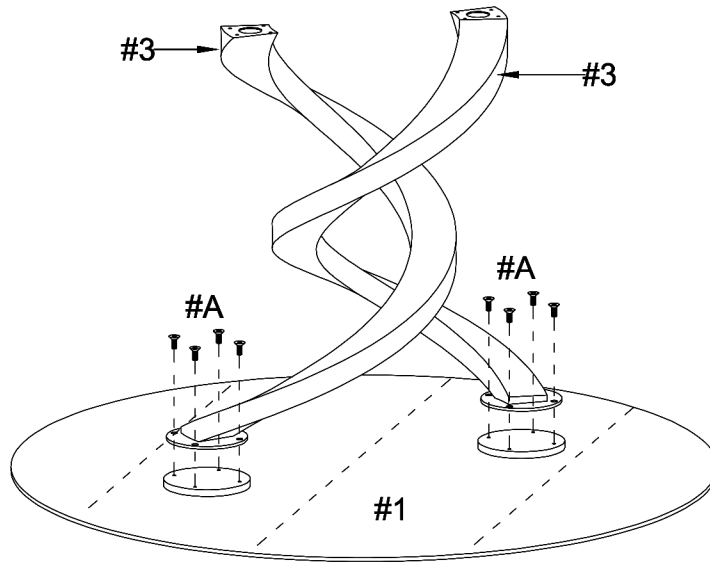

#B x 8pcs
#C x 8pcs
#D x 4pcs

- I. Align the pre-drilled holes on the base (#2) to the support legs (#3).
- II. Prepare 8 bolt assemblies by inserting the flat washer (#C) to the bolt (#B) and secure using the Allen wrench (#E).
- III. Insert the adjusters (#D)

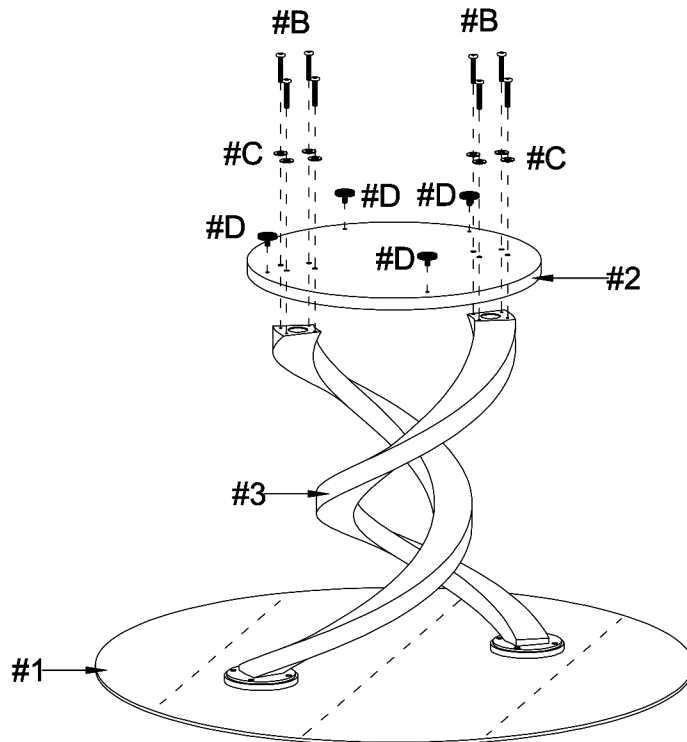

ASSEMBLY IS COMPLETED

ASSEMBLY INSTRUCTIONS

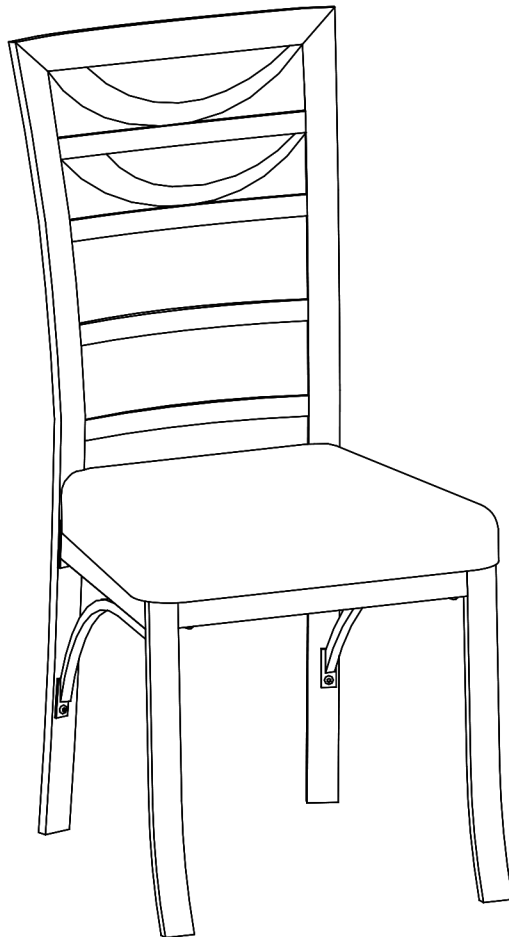

TOOLS REQUIRED



Allen Wrench
(Included)



2 - Persons
Recommended

ASSEMBLY RATING



EASY ————— DIFFICULT

The Assembly Rating is a 5-point system showing the level of effort needed to assemble a specific product.



CHECK BEFORE STARTING

Are you missing anything?

Double-check all parts, hardware and accessories listed on Page 6 are accounted for.

Check out our Quick Tips!

We recommend reviewing the pre-assembly handouts. Even experts need a refresher now and then!

Should we send any replacements?

Are there any irregularities or flaws in the parts? We can send replacements!

Prep Time!

Please review the assembly instructions and all diagrams prior to assembling. Arrange parts as recommended on Page 7 and group identical hardware together to make assembling easier.

PRE ASSEMBLY INTRODUCTION

We understand building ready-to-assemble furniture can be a challenging experience for some. To help avoid confusion, we have provided some helpful tips that may speed up the process.

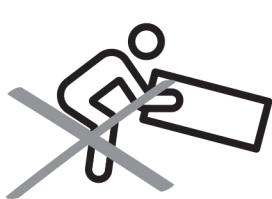

Teamwork

ALWAYS have at least two people to help with transporting and assembling the product to avoid potential injury and/or damage.

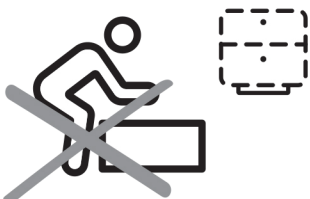

Suitable Location

Assembling near the area of the intended location is highly recommended.



Sufficient Space

Make sure you have enough space to move around during the assembly.

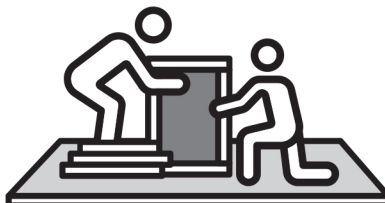

Avoid Scratches

Use cardboard, blankets or a carpeted area while assembling furniture to prevent scratches.

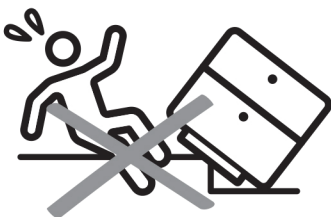

Flat Surface

Make sure the furniture rests on a flat and level surface with each leg evenly touching the floor.

ASSEMBLY AND CARE ADVICE



**FAILURE TO FOLLOW THE GUIDELINES BELOW MAY
RESULT IN INJURY AND/OR PROPERTY DAMAGE.**



Position each part correctly
and insert screws or bolts into
their respective holes.

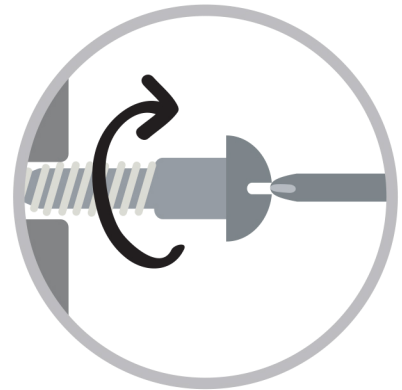

Turn clockwise to tighten and
only tighten when step is
completed or when instructed
to do so.



Use the appropriate hand tools
or power tools for assembly.
Select steps, such as tightening
screws and/or bolts, may require
hand tools to avoid causing
damage during assembly.



Save the instructions and store
any supplied tools for later
maintenance.

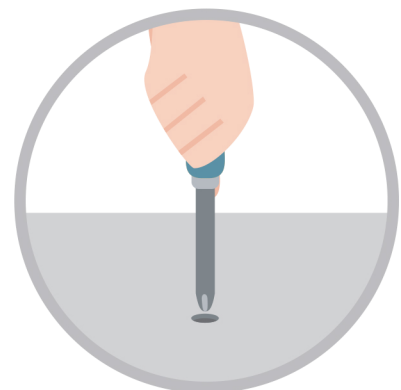

After two weeks, check and
tighten any loose hardware and
repeat again every six months
thereafter.

IT IS THE USER'S RESPONSIBILITY TO MAINTAIN THE FURNITURE. THE HARDWARE MAY LOOSEN OVER TIME AND MAY CAUSE THE FURNITURE TO BE WOBBLY AND UNABLE TO SUPPORT ITS INTENDED WEIGHT CAPACITY. THIS MAY LEAD TO COLLAPSE AND MAY CAUSE SERIOUS INJURY.

CHAIR



- Please keep instructions for future reference.
- Check the quantity and irregularity of parts and hardware before you start.

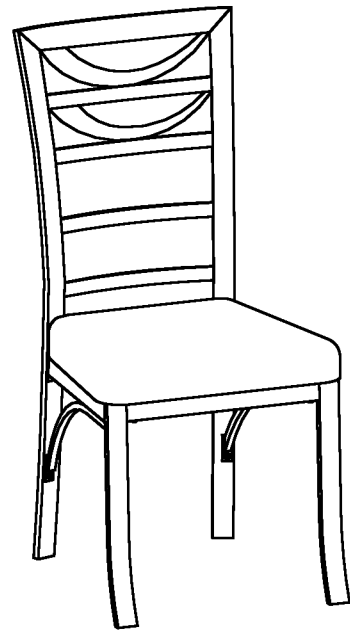

PARTS

#1 2pcs



Leg (L & R)

#3 1pc

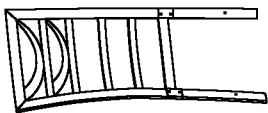

Backrest W/Legs

#2 1pc

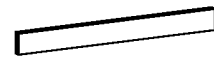

Rail

#4 1pc



Cushion

HARDWARE

#A 8pcs



Bolt $\text{\O}1/4" \times 1/2"$

#B 4pcs



Wood screw $\text{\O}3/16" \times 5/8"$

#C 4pcs



Stopper

#D 1pc

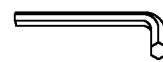

Allen Wrench

ASSEMBLY INSTRUCTIONS

1

Part #1 x2pcs

Part #2 x1pc

Hardware #A x2pcs

Hardware #D x1pc

- I. Insert the left leg (#1L) and right leg (#1R) onto the rail (#2).
- II. Insert 2 bolts (#A) and secure using the Allen wrench (#D).

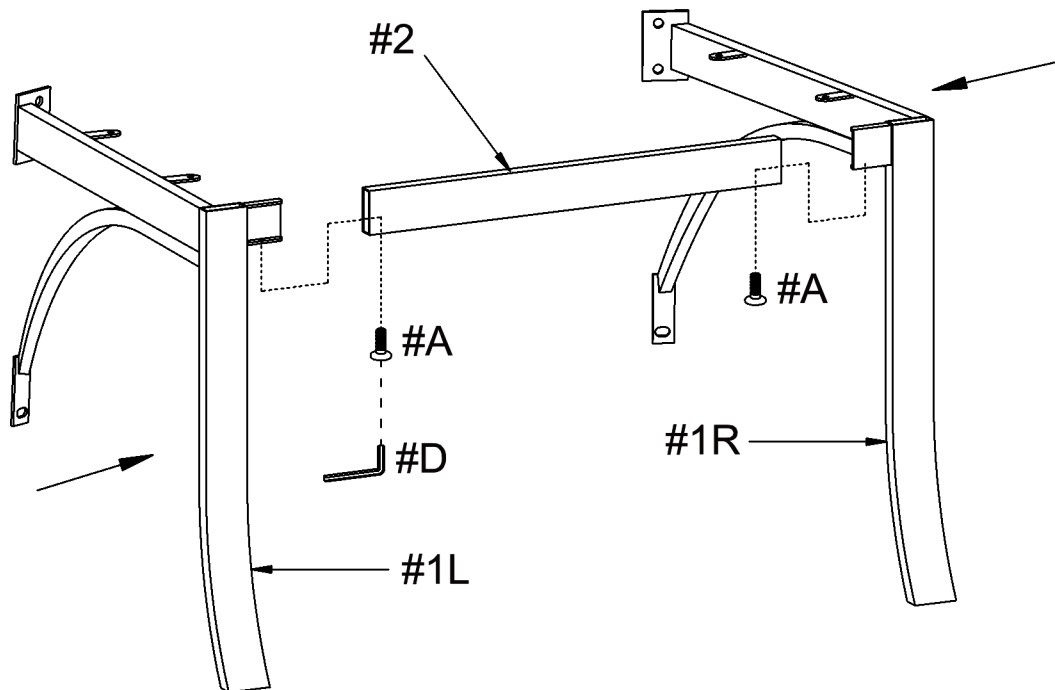

ASSEMBLY INSTRUCTIONS

2

Part #3 x1pc

Hardware #A x6pcs

Hardware #D x1pc

- I. Align the pre-drilled holes on the legs (#1) to the pre-drilled holes on the backrest with legs (#3).
- II. Insert 6 bolts (#A) and secure using the Allen wrench (#D).

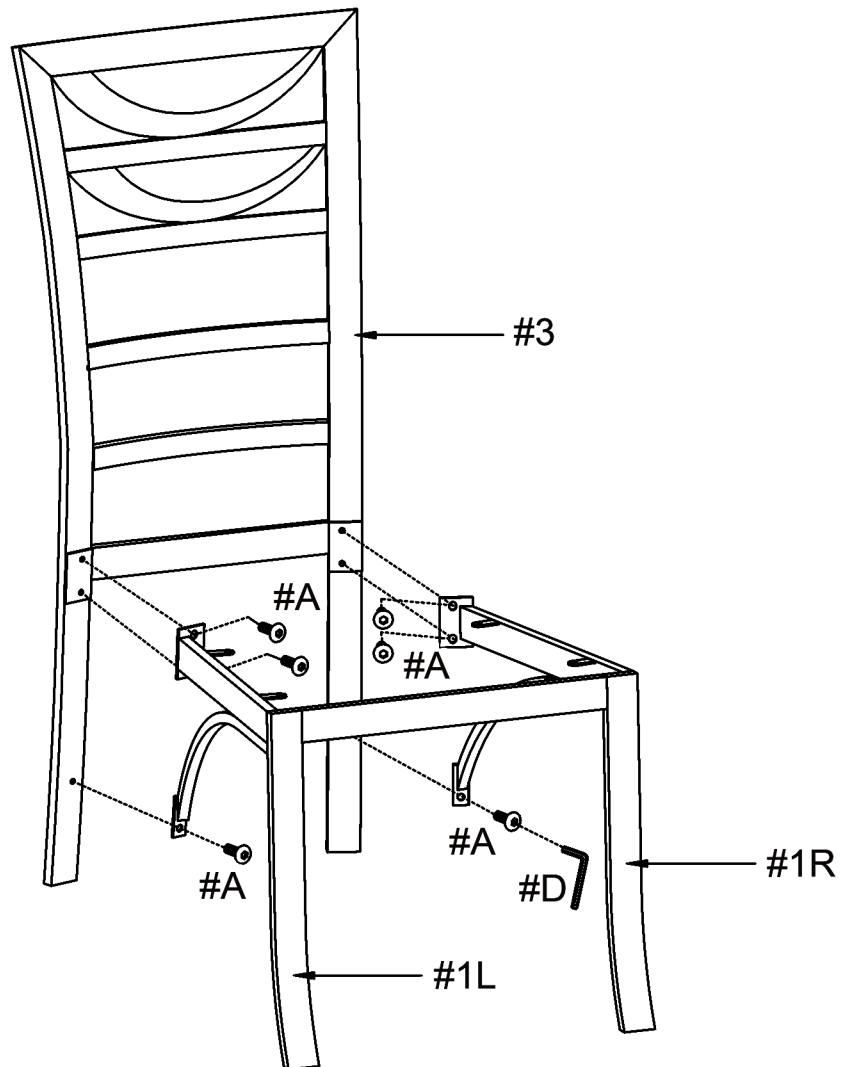

ASSEMBLY INSTRUCTIONS

3

Part #4 x1pc

Hardware #B x4pcs

Hardware #C x4pcs

- I. Align the cushion (#4) to the pre-drilled holes on the chair frame.
- II. Insert 4 wood screws (#B) and secure using a Phillips screwdriver.
- III. Insert the stoppers (#C) into the bottom of the legs.

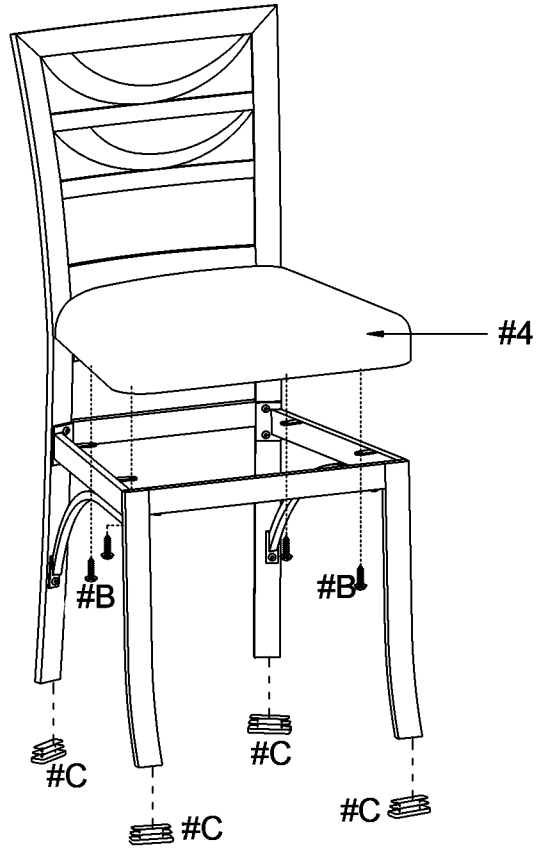

4

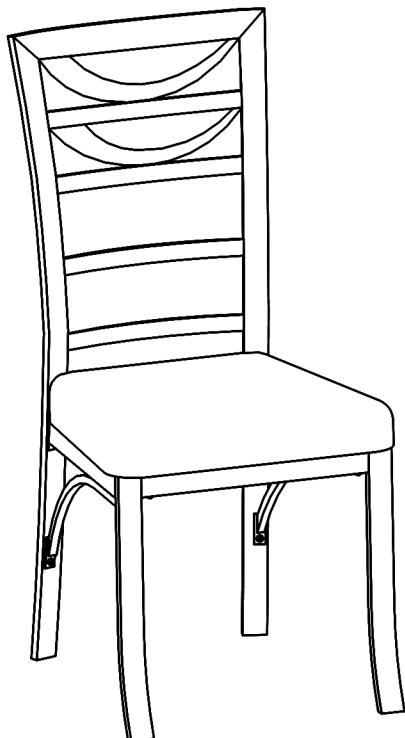

ASSEMBLY COMPLETED



Please ensure the furniture rests on an even and flat surface. If the product wobbles or feels loose, double-check all bolts and/or screws are properly tightened and secured.



Keep this handy!

Please retain this instruction manual and any order-related information for future reference.