

ASSEMBLY INSTRUCTIONS

TOOLS REQUIRED



Allen Wrench

(Included)

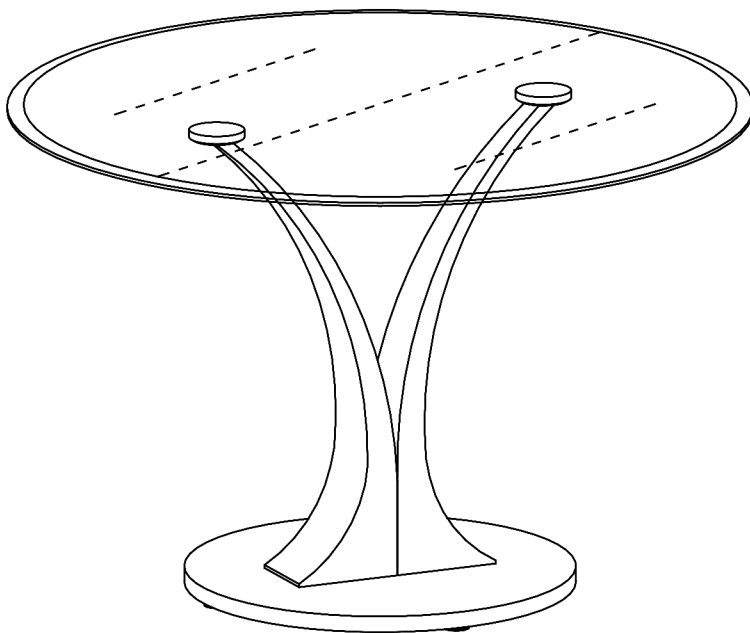

2 - Persons
Recommended

ASSEMBLY RATING

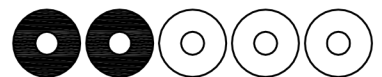

EASY ————— DIFFICULT

The Assembly Rating is a 5-point system showing the level of effort needed to assemble a specific product.



CHECK BEFORE STARTING

Are you missing anything?

Double-check all parts, hardware and accessories listed on Page 6 are accounted for.

Should we send any replacements?

Are there any irregularities or flaws in the parts? We can send replacements!

Check out our Quick Tips!

We recommend reviewing the pre-assembly handouts. Even experts need a refresher now and then!

Prep Time!

Please review the assembly instructions and all diagrams prior to assembling. Arrange parts as recommended on Page 7 and group identical hardware together to make assembling easier.

PRE ASSEMBLY INTRODUCTION

We understand building ready-to-assemble furniture can be a challenging experience for some. To help avoid confusion, we have provided some helpful tips that may speed up the process.

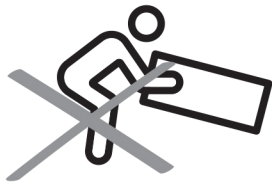

Teamwork

ALWAYS have at least two people to help with transporting and assembling the product to avoid potential injury and/or damage.

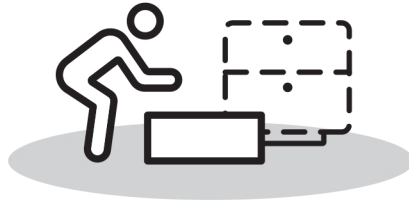
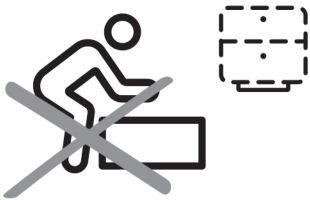

Suitable Location

Assembling near the area of the intended location is highly recommended.



Sufficient Space

Make sure you have enough space to move around during the assembly.



Avoid Scratches

Use cardboard, blankets or a carpeted area while assembling furniture to prevent scratches.

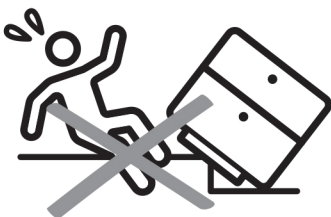

Flat Surface

Make sure the furniture rests on a flat and level surface with each leg evenly touching the floor.

ASSEMBLY AND CARE ADVICE



**FAILURE TO FOLLOW THE GUIDELINES BELOW MAY
RESULT IN INJURY AND/OR PROPERTY DAMAGE.**



Position each part correctly
and insert screws or bolts into
their respective holes.

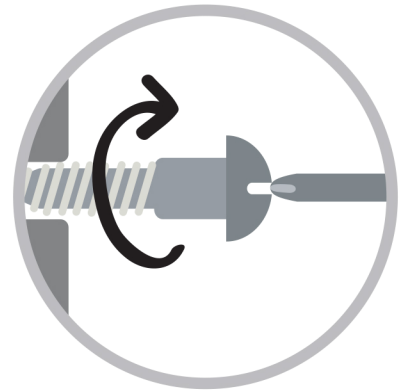

Turn clockwise to tighten and
only tighten when step is
completed or when instructed
to do so.



Use the appropriate hand tools
or power tools for assembly.
Select steps, such as tightening
screws and/or bolts, may require
hand tools to avoid causing
damage during assembly.



Save the instructions and store
any supplied tools for later
maintenance.

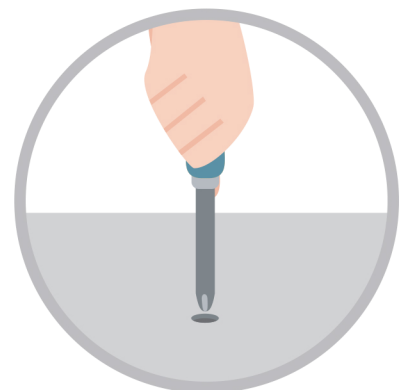

After two weeks, check and
tighten any loose hardware and
repeat again every six months
thereafter.

IT IS THE USER'S RESPONSIBILITY TO MAINTAIN THE FURNITURE. THE HARDWARE MAY LOOSEN OVER TIME AND MAY CAUSE THE FURNITURE TO BE WOBBLY AND UNABLE TO SUPPORT ITS INTENDED WEIGHT CAPACITY. THIS MAY LEAD TO COLLAPSE AND MAY CAUSE SERIOUS INJURY.

TABLE



- Please keep instructions for future reference.
- Check the quantity and irregularity of parts and hardware before you start.

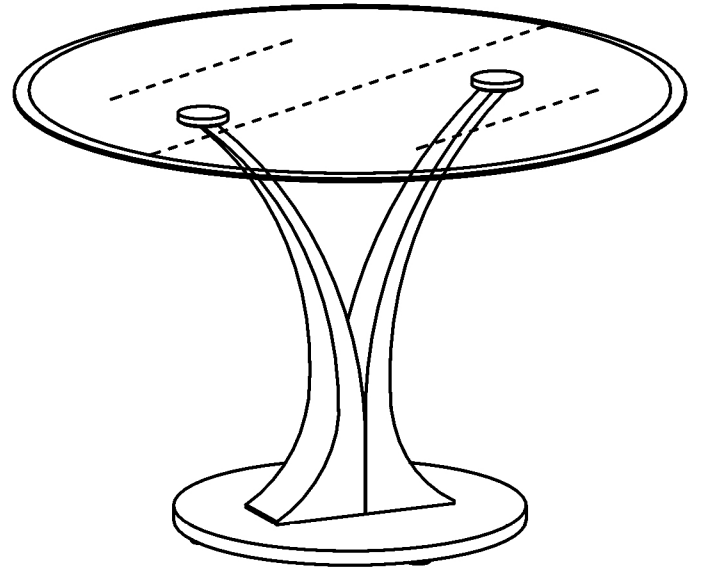

PARTS

#1 1pc

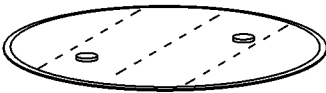

Glass Top

#2 1pc

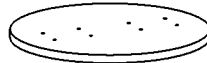

Base

#3 2pcs



Support Leg

HARDWARE

#A 4pcs



Bolt $\text{\O}1/4"$ x $3/8"$

#B 8pcs



Bolt $\text{\O}1/4"$ x $1-1/4"$

#C 8pcs



Flat Washer

#D 4pcs



Adjuster $\text{\O}1/4"$ x $1/2"$

#E 1pc

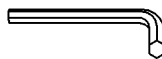

Allen Wrench

ASSEMBLY INSTRUCTIONS

1

Part #1 x1pc

Part #3 x2pcs

Hardware #A x4pcs

Hardware #E x1pc

- I. With the help of another person, carefully place the glass top (#1) facing down on a protected surface.
- II. Align the 2 legs (#3) with the pre-drilled holes on the bottom of the glass top (#1).
- III. Insert 4 screws (#A) through the 2 legs (#3) and secure those screws using the Allen wrench (#E) to lock them with the glass top (#1).

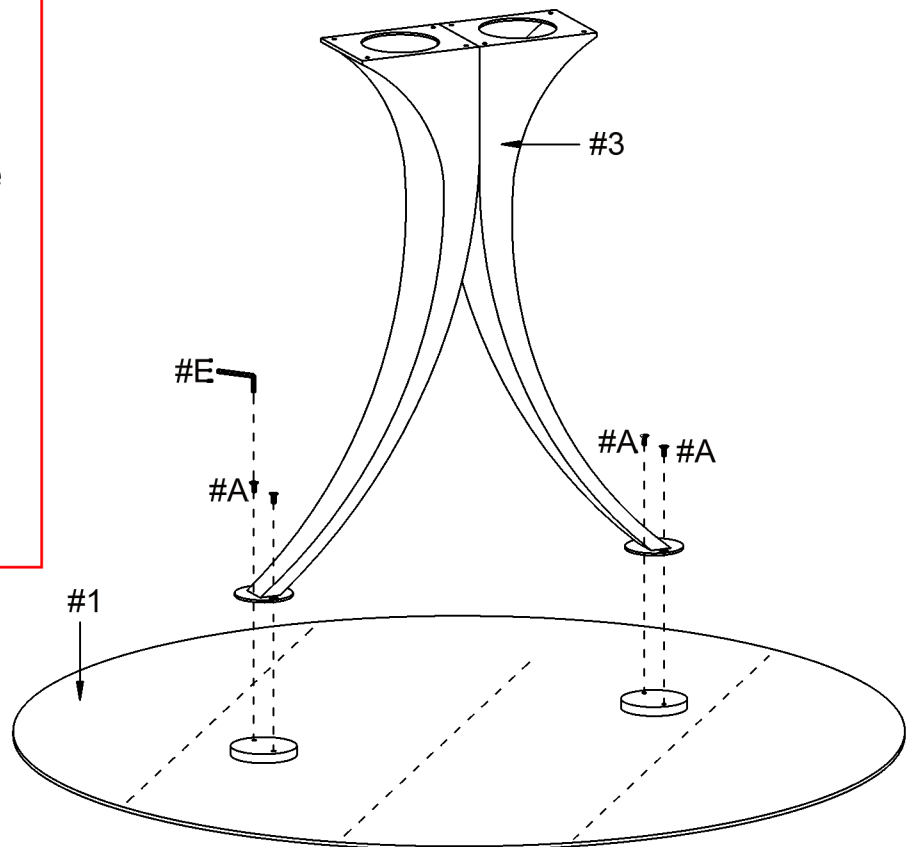

ASSEMBLY INSTRUCTIONS

2

- Part #2 x1pc
- Part #3 x2pcs
- Hardware #B x8pcs
- Hardware #C x8pcs
- Hardware #D x4pcs
- Hardware #E x1pc

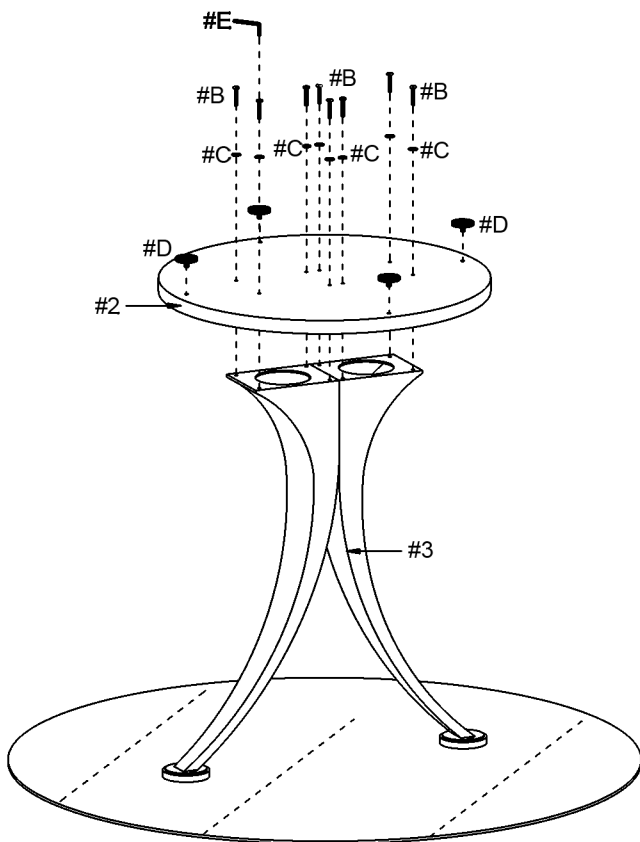

- I. Align the base (#2) with the pre-drilled holes of the 2 legs (#3).
- II. Prepare 8 bolt assemblies by inserting the lock washer (#C) onto the screw (#B).
- III. Insert the bolt assemblies through the pre-drilled holes from the bottom of the base (#2) and secure those screws using the Allen wrench (#E) to lock them with the legs (#3).
- IV. Align the threaded end of the 4 glides (#D) with the pre-drilled holes on the bottom of the base (#2) and tighten by hand until secured.
- V. With the help of another person, carefully place the table in upright position. Make sure the table is rested on a flat surface and does not feel loose or wobbly. If it does, double check that the bolts/screws are secured and properly tightened.

3

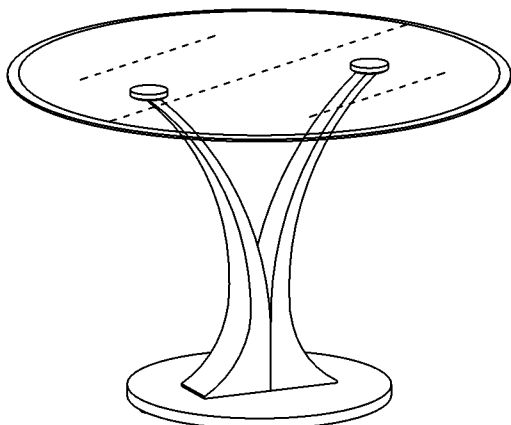

ASSEMBLY COMPLETED



Please ensure the furniture rests on an even and flat surface. If the product wobbles or feels loose, double-check all bolts and/or screws are properly tightened and secured.



Keep this handy!

Please retain this instruction manual and any order-related information for future reference.

ASSEMBLY INSTRUCTIONS

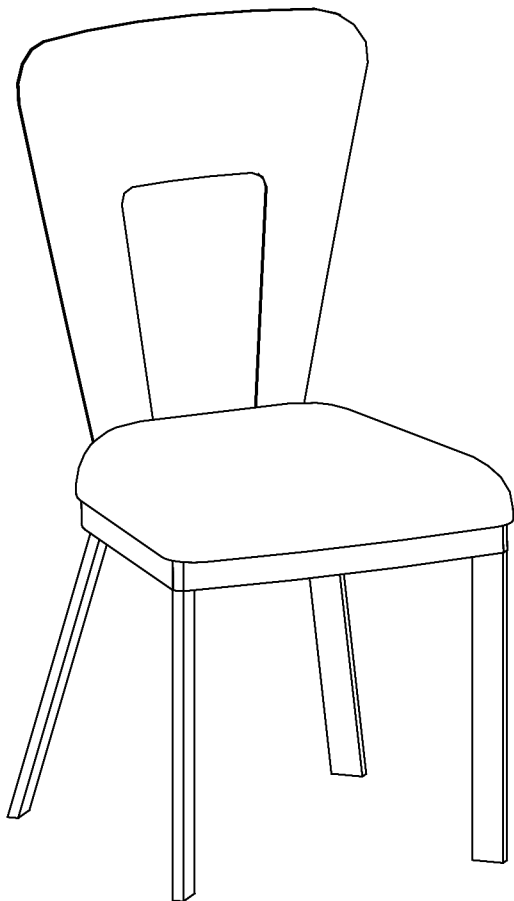

TOOLS REQUIRED



Phillips
Screwdriver

(Not Included)



2 - Persons
Recommended

ASSEMBLY RATING

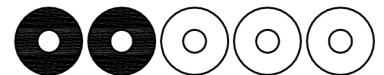

EASY ————— DIFFICULT

The Assembly Rating is a 5-point system showing the level of effort needed to assemble a specific product.



CHECK BEFORE STARTING

Are you missing anything?

Double-check all parts, hardware and accessories listed on Page 6 are accounted for.

Check out our Quick Tips!

We recommend reviewing the pre-assembly handouts. Even experts need a refresher now and then!

Should we send any replacements?

Are there any irregularities or flaws in the parts? We can send replacements!

Prep Time!

Please review the assembly instructions and all diagrams prior to assembling. Arrange parts as recommended on Page 7 and group identical hardware together to make assembling easier.

PRE ASSEMBLY INTRODUCTION

We understand building ready-to-assemble furniture can be a challenging experience for some. To help avoid confusion, we have provided some helpful tips that may speed up the process.

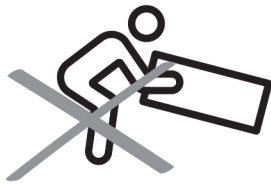

Teamwork

ALWAYS have at least two people to help with transporting and assembling the product to avoid potential injury and/or damage.

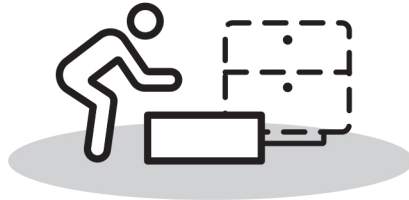
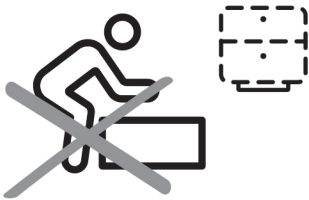

Suitable Location

Assembling near the area of the intended location is highly recommended.



Sufficient Space

Make sure you have enough space to move around during the assembly.



Avoid Scratches

Use cardboard, blankets or a carpeted area while assembling furniture to prevent scratches.

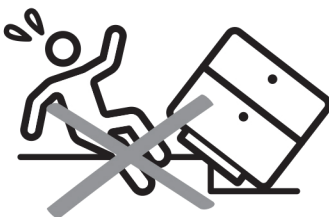

Flat Surface

Make sure the furniture rests on a flat and level surface with each leg evenly touching the floor.

ASSEMBLY AND CARE ADVICE



FAILURE TO FOLLOW THE GUIDELINES BELOW MAY RESULT IN INJURY AND/OR PROPERTY DAMAGE.



Position each part correctly and insert screws or bolts into their respective holes.

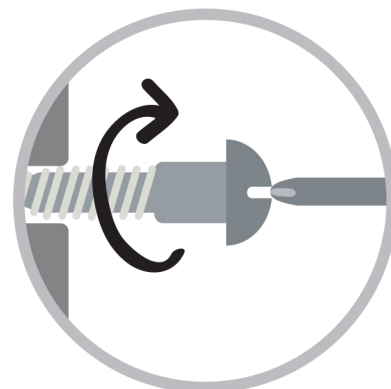

Turn clockwise to tighten and only tighten when step is completed or when instructed to do so.



Use the appropriate hand tools or power tools for assembly. Select steps, such as tightening screws and/or bolts, may require hand tools to avoid causing damage during assembly.



Save the instructions and store any supplied tools for later maintenance.

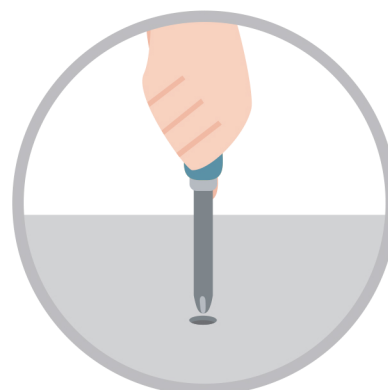

After two weeks, check and tighten any loose hardware and repeat again every six months thereafter.

IT IS THE USER'S RESPONSIBILITY TO MAINTAIN THE FURNITURE. THE HARDWARE MAY LOOSEN OVER TIME AND MAY CAUSE THE FURNITURE TO BE WOBBLY AND UNABLE TO SUPPORT ITS INTENDED WEIGHT CAPACITY. THIS MAY LEAD TO COLLAPSE AND MAY CAUSE SERIOUS INJURY.

CHAIR



- Please keep instructions for future reference.
- Check the quantity and irregularity of parts and hardware before you start.

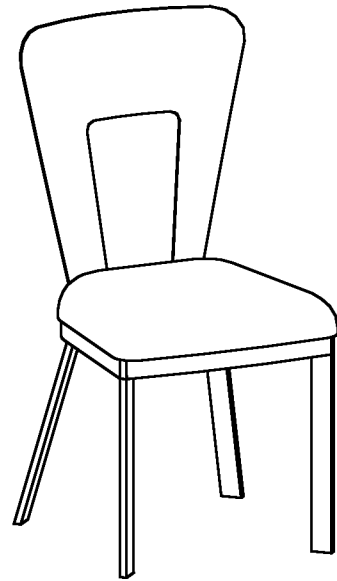

PARTS

#1 1pc

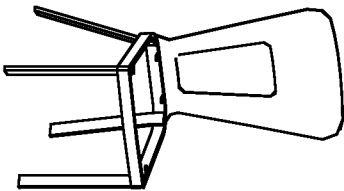

Chair Frame

#2 1pc



Seat Cushion

HARDWARE

#A 4pcs

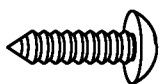

Screw 3/16" x 1/2"

#B 4pcs

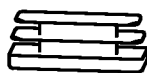

Stopper

ASSEMBLY INSTRUCTIONS

1

- Part #1 x1pc
- Part #2 x1pc
- Hardware #A x4pcs
- Hardware #B x4pcs

Align seat (#2) to chair frame (#1), then secure by using screws (#A). There will be no pre-drilled holes.

Attach stoppers (#B) to the bottom of the legs.

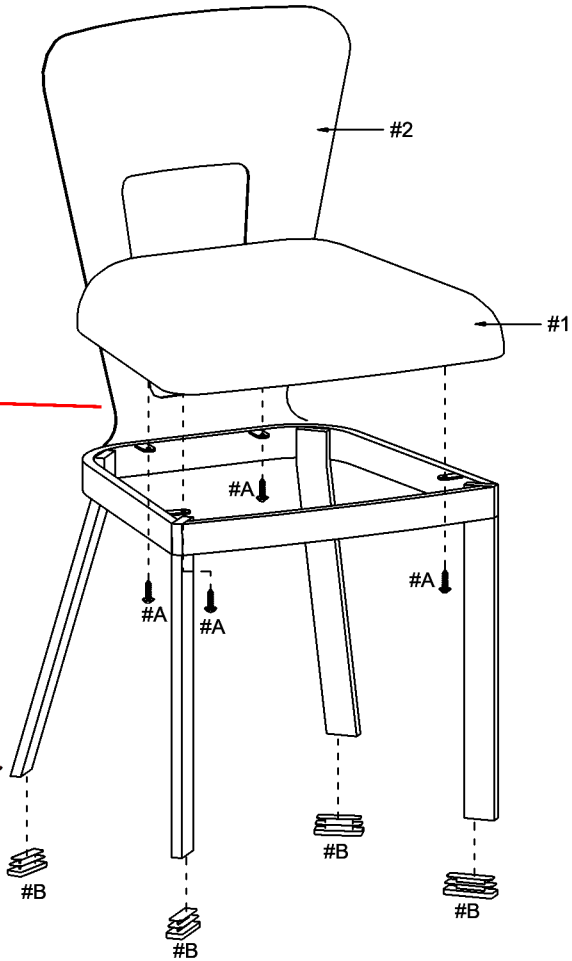

2

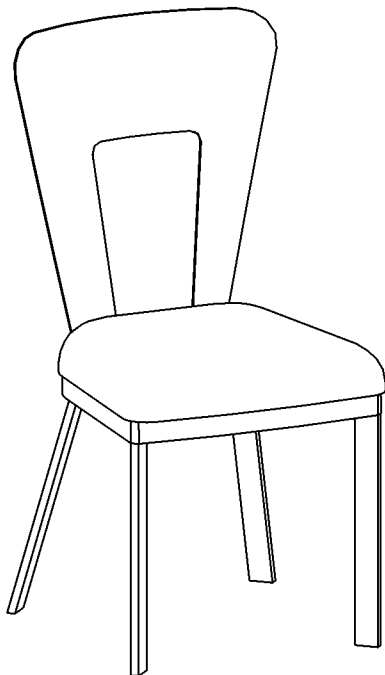

ASSEMBLY COMPLETED



Please ensure the furniture rests on an even and flat surface. If the product wobbles or feels loose, double-check all bolts and/or screws are properly tightened and secured.



Keep this handy!

Please retain this instruction manual and any order-related information for future reference.