

# ASSEMBLY INSTRUCTIONS

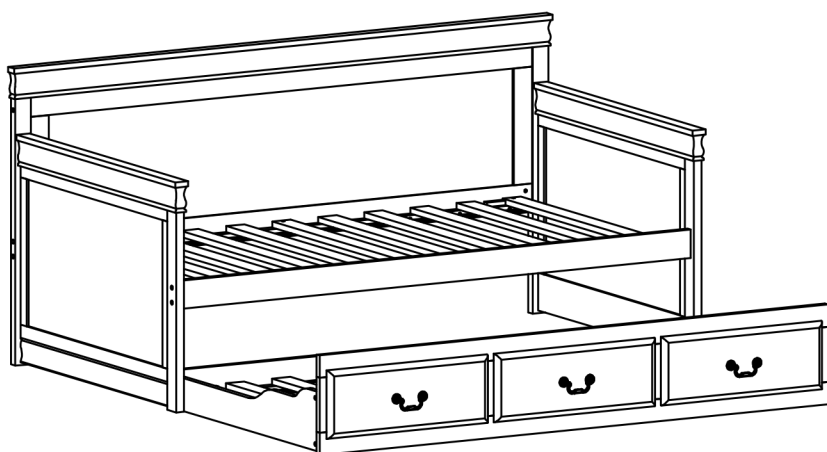

## TOOLS REQUIRED

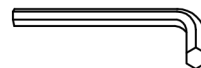

Allen Wrench

(Included)



Phillips  
Screwdriver

(Not Included)



3 - People  
Recommended

## ASSEMBLY RATING



EASY —————> DIFFICULT

The Assembly Rating is a 5-point system showing the level of effort needed to assemble a specific product.



## **CHECK BEFORE STARTING**

### **Are you missing anything?**

Double-check all parts, hardware and accessories listed on Page 6 are accounted for.

### **Check out our Quick Tips!**

We recommend reviewing the pre-assembly handouts. Even experts need a refresher now and then!

### **Should we send any replacements?**

Are there any irregularities or flaws in the parts? We can send replacements!

### **Prep Time!**

Please review the assembly instructions and all diagrams prior to assembling. Arrange parts as recommended on Page 7 and group identical hardware together to make assembling easier.

# PRE ASSEMBLY INTRODUCTION

We understand building ready-to-assemble furniture can be a challenging experience for some. To help avoid confusion, we have provided some helpful tips that may speed up the process.

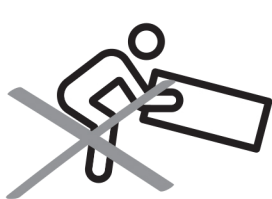

## Teamwork

ALWAYS have at least two people to help with transporting and assembling the product to avoid potential injury and/or damage.



## Suitable Location

Assembling near the area of the intended location is highly recommended.



## Sufficient Space

Make sure you have enough space to move around during the assembly.

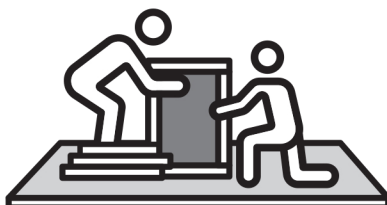

## Avoid Scratches

Use cardboard, blankets or a carpeted area while assembling furniture to prevent scratches.



## Flat Surface

Make sure the furniture rests on a flat and level surface with each leg evenly touching the floor.

# ASSEMBLY AND CARE ADVICE



**FAILURE TO FOLLOW THE GUIDELINES BELOW MAY RESULT IN INJURY AND/OR PROPERTY DAMAGE.**



Position each part correctly and insert screws or bolts into their respective holes.

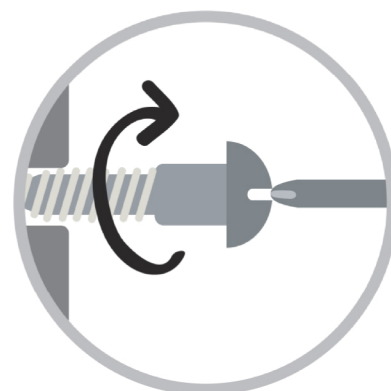

Turn clockwise to tighten and only tighten when step is completed or when instructed to do so.



Use the appropriate hand tools or power tools for assembly. Select steps, such as tightening screws and/or bolts, may require hand tools to avoid causing damage during assembly.



Save the instructions and store any supplied tools for later maintenance.



After two weeks, check and tighten any loose hardware and repeat again every six months thereafter.

**IT IS THE USER'S RESPONSIBILITY TO MAINTAIN THE FURNITURE. THE HARDWARE MAY LOOSEN OVER TIME AND MAY CAUSE THE FURNITURE TO BE WOBBLY AND UNABLE TO SUPPORT ITS INTENDED WEIGHT CAPACITY. THIS MAY LEAD TO COLLAPSE AND MAY CAUSE SERIOUS INJURY.**

# DAYBED W/ TWIN TRUNDLE

---



- Please keep instructions for future reference.
- Check the quantity and irregularity of parts and hardware before you start.

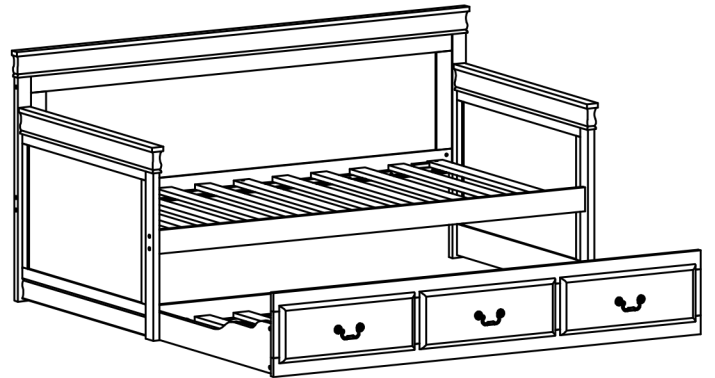

## PARTS

#1 1pc

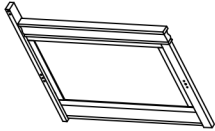

Headboard panel (Right)

#2 1pc

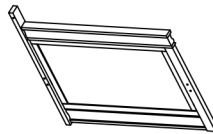

Headboard panel (Left)

#3 1pc



Rear Rail

#4 1pc



Front Rail

#5 2pcs

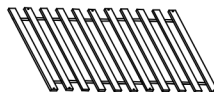

Twin Slat Kit

#6 1pc

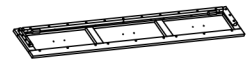

Front Frame

#7 1pc



Back Panel

#8 1pc



Right End Panel

#9 1pc



Left End Panel

# DAYBED W/ TWIN TRUNDLE

---



- Please keep instructions for future reference.
- Check the quantity and irregularity of parts and hardware before you start.

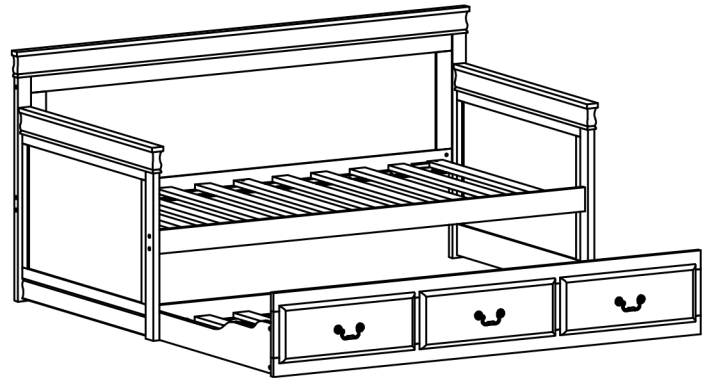

## HARDWARE

#A 4pcs

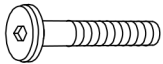

Bolt Ø1/4"x2-3/8"

#B 6pcs

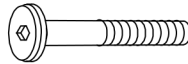

Bolt Ø1/4"x3-15/16"

#C 8pcs

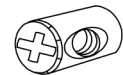

Barrel Nut Ø1/4"x1/2"

#D 6pcs

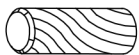

Wood Dowel  
Ø3/8"x1-9/16"

#E 8pcs

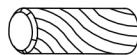

Wood Dowel \  
Ø3/8"x1-3/16"

#F 8pcs

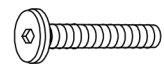

Bolt Ø1/4"x1-3/16"

#G 12pcs

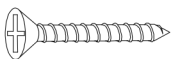

Screw Ø5/32"x1-3/16"

#H 3pcs



Pull Handle

#I 6pcs

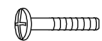

Screw Ø5/32"x1"

#J 10pcs

















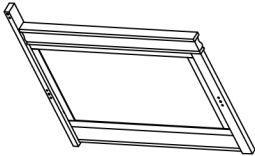



Wood Knob

#K 1pc

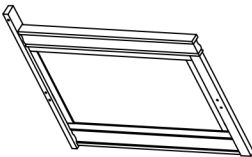
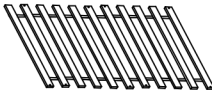

Allen Wrench

Carton	Designation	Part		Hardware
	Rear Rail	#3		
	Front Rail	#4		
	Front Frame	#6		
	Back Panel	#7		
	Right End Panel	#8		
	Left End Panel	#9		
	Headboard panel (Right)	#1		 #A x 4pcs  #B x 6pcs  #C x 8pcs  #D x 6pcs  #E x 8pcs  #F x 8pcs  #G x 12pcs  #H x 3pcs  #I x 6pcs  #J x 10pcs  #K x 1pc
	Headboard panel (Left)	#2		
	Twin Slat Kit	#5	 x 2	

# Exploded View

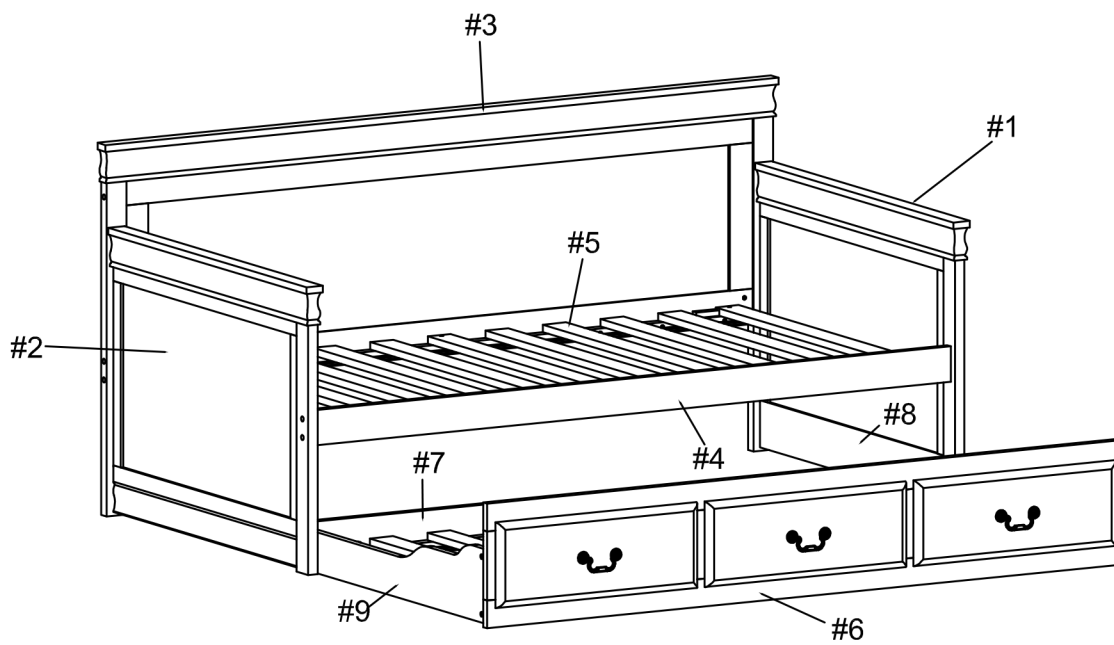

# ASSEMBLY INSTRUCTIONS

1  
Insert dowels (#D) to rear and front rails (#3,4), then align rear and front rails (#3,4) to the headboards (#1,2). Secure by using bolts (#B) onto barrel nuts (#C). Insert plugs (#J) to the holes of bolts (#B).

- Part #1 x1pc
- Part #2 x1pc
- Part #3 x1pc
- Part #4 x1pc
- Hardware #A x4pcs
- Hardware #B x6pcs
- Hardware #C x8pcs
- Hardware #D x6pcs
- Hardware #J x10pcs

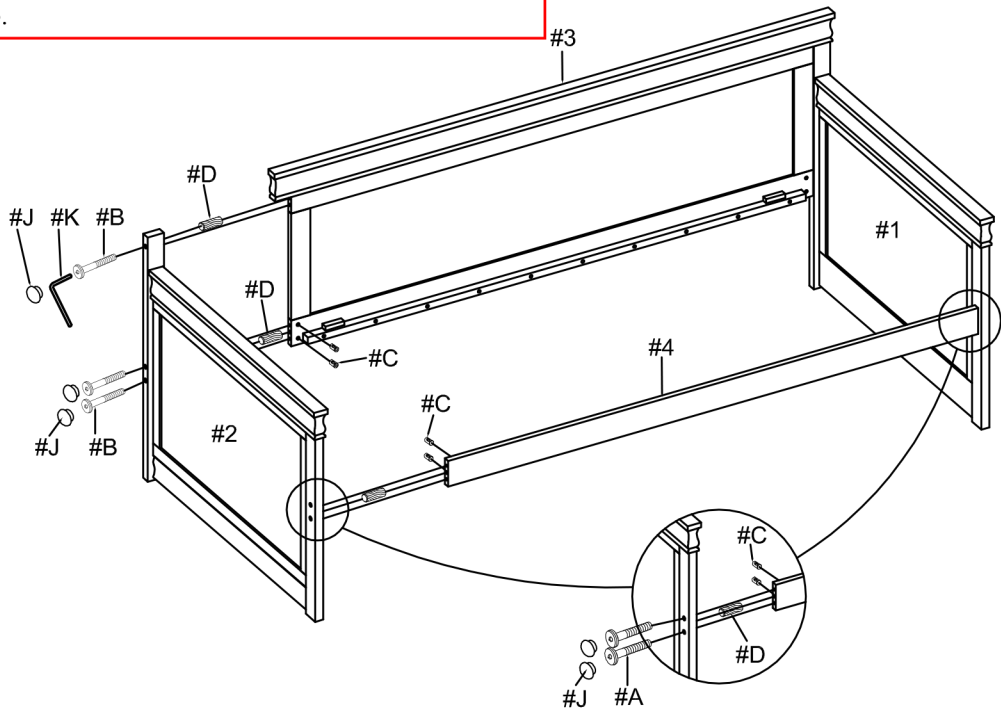

## 2

- Part #5 x1pc
- Hardware #G x6pcs

Align slats (#5) to the unit, then secure by using screws (#G).

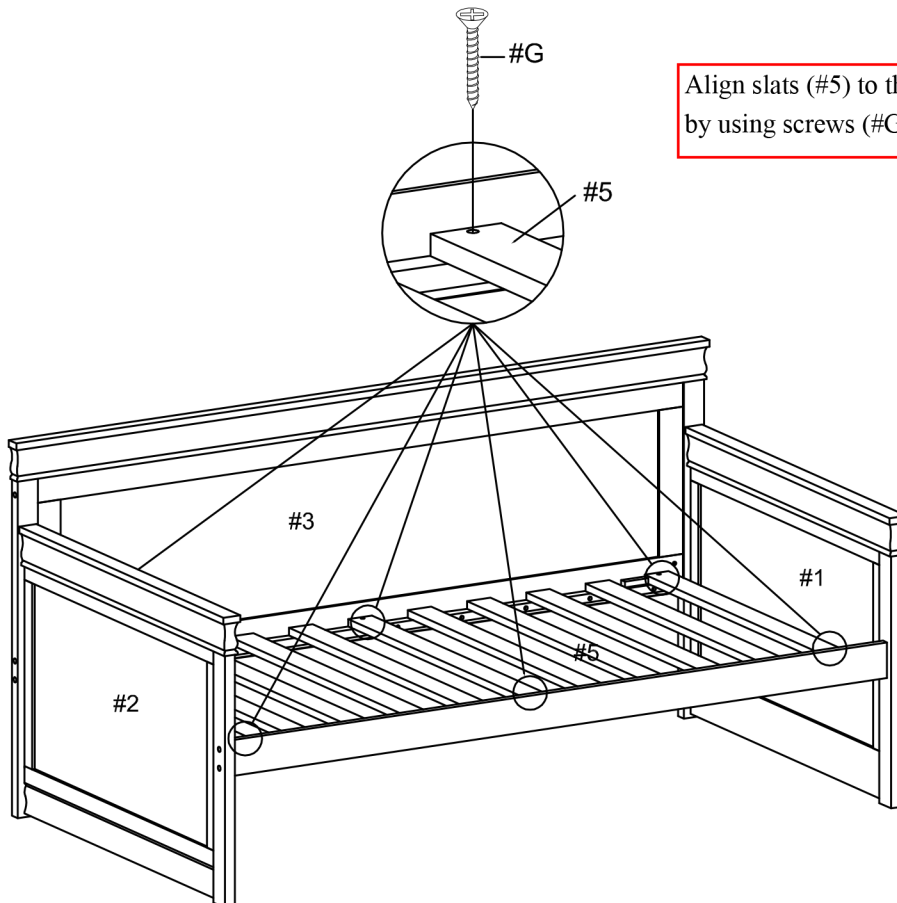

# ASSEMBLY INSTRUCTIONS

## 3

- Part #6 x1pc
- Part #7 x1pc
- Part #8 x1pc
- Part #9 x1pc
- Hardware #E x8pcs
- Hardware #F x8pcs
- Hardware #H x3pcs
- Hardware #I x6pcs

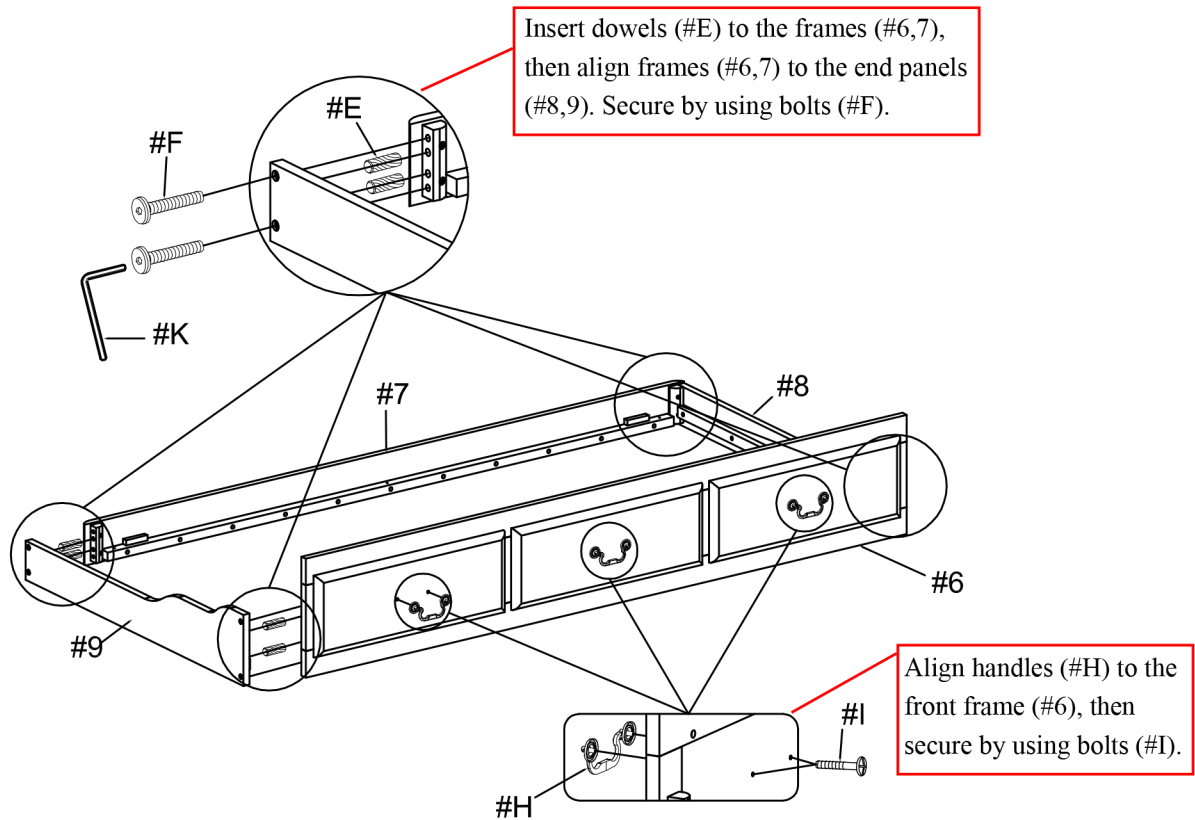

Insert screws into pull handle (#H) using a Phillips screwdriver.

## 4

- Part #5 x1pc
- Hardware #G x6pcs

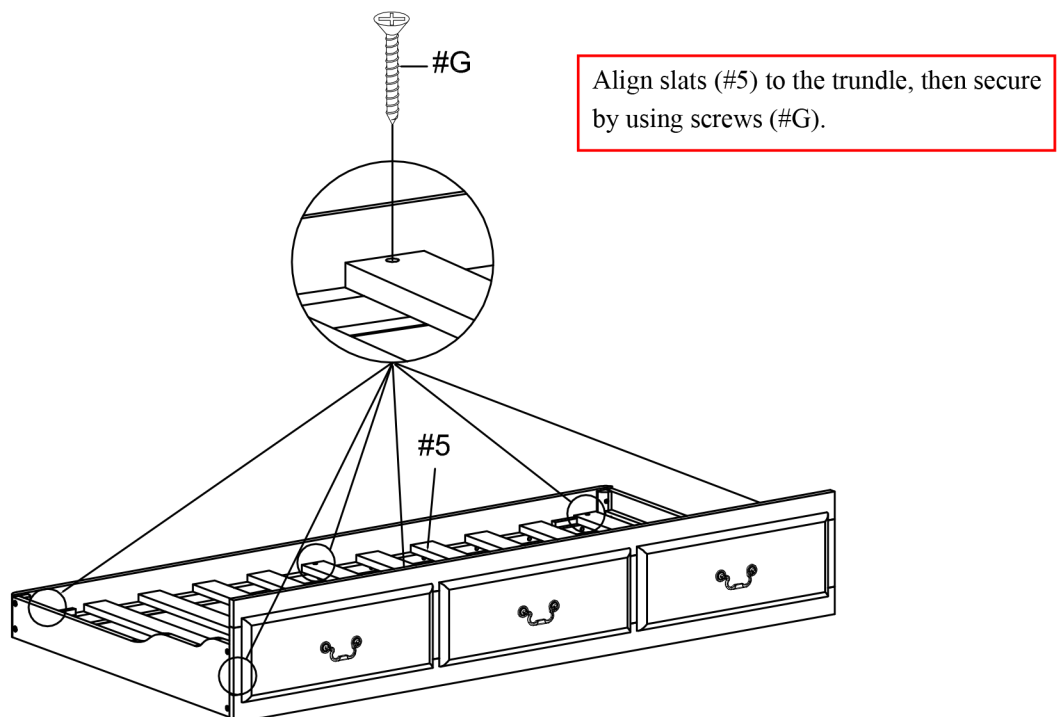

# ASSEMBLY INSTRUCTIONS

5

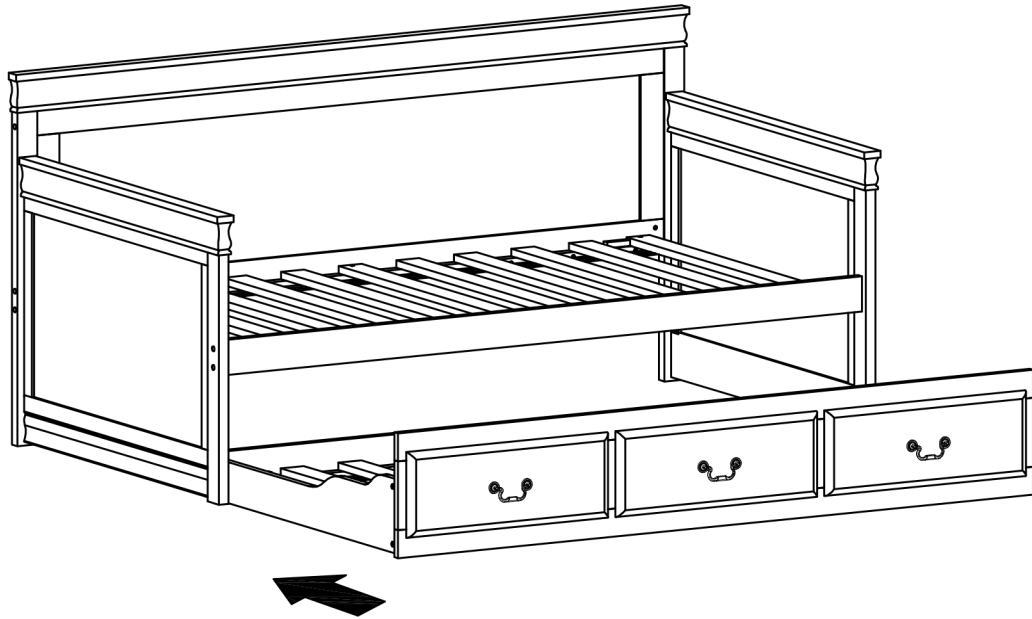

6

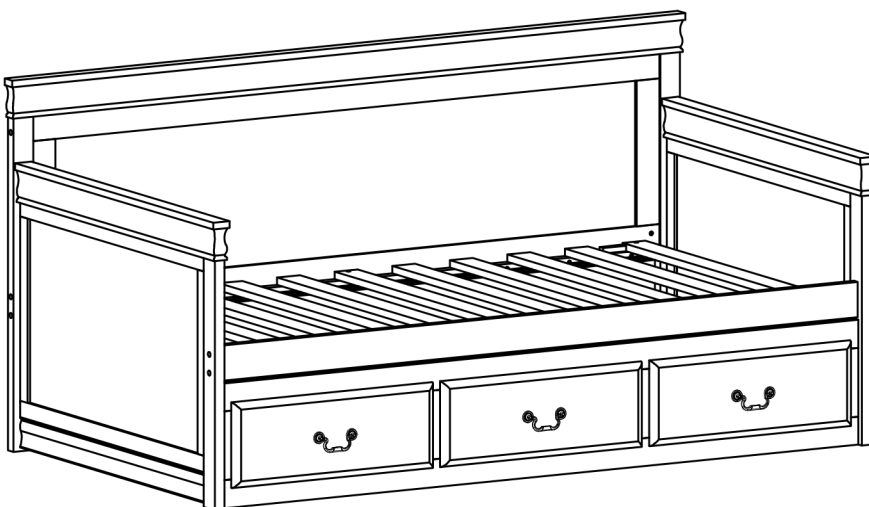

## ASSEMBLY COMPLETED



Please ensure the furniture rests on an even and flat surface. If the product wobbles or feels loose, double-check all bolts and/or screws are properly tightened and secured.



### Keep this handy!

Please retain this instruction manual and any order-related information for future reference.



### Lift, don't drag!

To avoid damage to product please always LIFT the product when transporting or adjusting the placement.