

ASSEMBLY INSTRUCTION FOR ACME FURNITURE

MODEL#LV01142

Thank you for purchasing the quality product. Be sure to check all packing material carefully for small parts which may have come loose inside the carton during shipment. Separate, identify and count all parts and metal hardware. Compare with all parts list to be sure all parts are present. If any part(s) are missing or damaged, please contact your local furniture dealer. For efficient and speedy service, please indicate the model number and code letter of part(s) needed.

*****Do not fully tighten screws until fully assembled*****

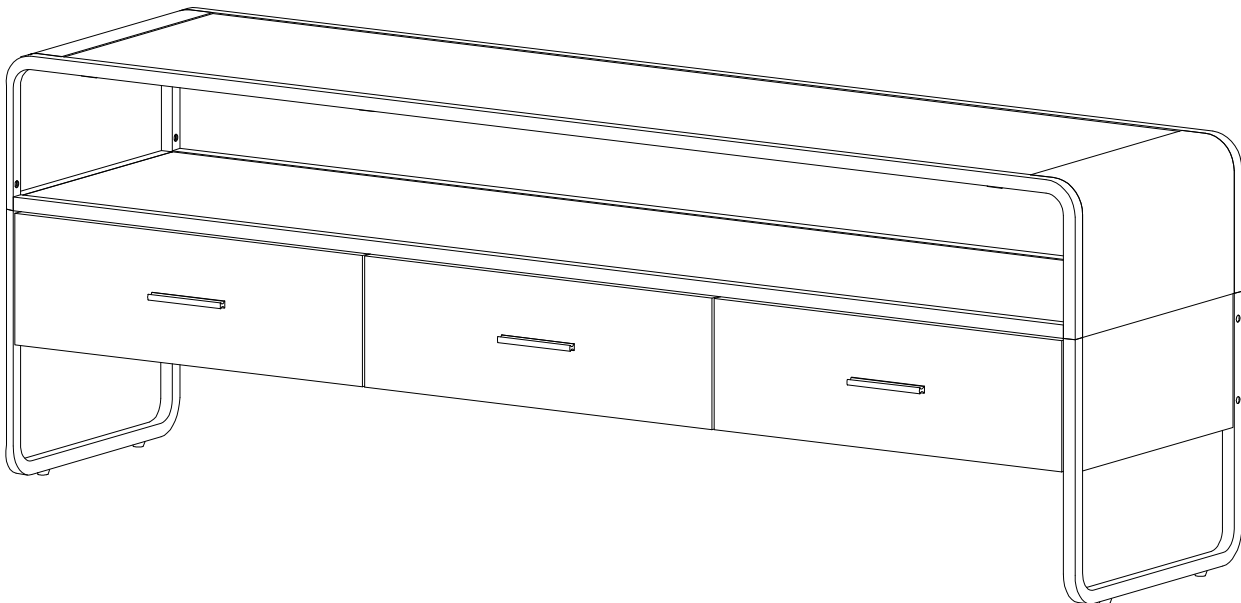

Attention:

*****Some number parts listed on the instruction sheet may not be in parts bag as they may already be assembled. Carefully check parts and packing materials prior to ordering replacements.**

General Assembly Guidelines



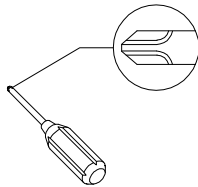

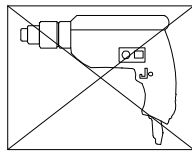

- I. Ensure that all parts and hardware are available before beginning assembly.
- II. Follow each step carefully to ensure the proper assembly of this product.
- III. Two people are recommended for ease in the assembly of this product.
- IV. The three main types of hardware used to assemble this product are: wood dowels, screws and bolts.
- V. A Phillips head screwdriver is required for the assembly of this product.



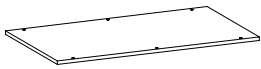
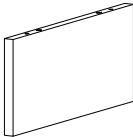



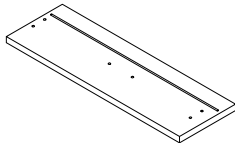
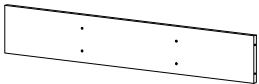
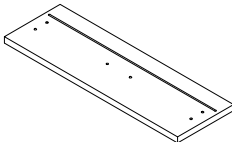
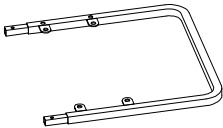
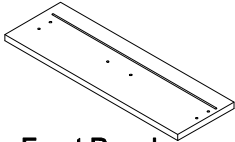
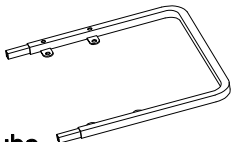
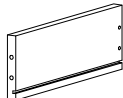
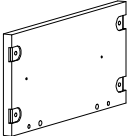
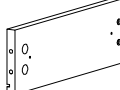
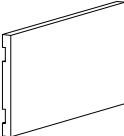
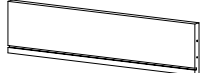
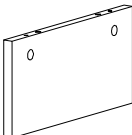



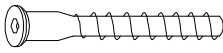

- VI. Power tools should not be used to assemble this product.

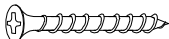

COMPONENT PARTS

DESCRIPTION	PART NAME	QTY(PCS)	DESCRIPTION	PART NAME	QTY(PCS)
①	 Table Top	1	⑩	 Middle Side Panel	1
②	 Metal Tube	1	⑪	 Table Bottom	1
③	 Shelf	1	⑫	 Drawer Front Panel	1
④	 Back panel	1	⑬	 Drawer Front Panel	1
⑤	 Metal Tube	1	⑭	 Drawer Front Panel	1
⑥	 Metal Tube	1	⑮	 Drawer Side Panel(L)	3
⑦	 Left Side Panel	1	⑯	 Drawer Side Panel(R)	3
⑧	 Right Side Panel	1	⑰	 Drawer Back Panel	3
⑨	 Middle Side Panel	1	⑱	 Drawer Bottom Panel	3

Hardware List

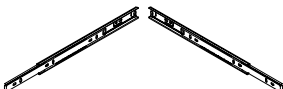
A		Ø1/4"*12mm	Bolt	24 pcs
B		Ø6x50mm	Screw	12 pcs
C		Ø6*35mm	Cam bolt	20 pcs
D		Ø15*12mm	Cam lock	20 pcs
E		Ø8*30mm	Wooden dowel	12 pcs
F		Ø4x30mm	Screw	12 pcs
H		Ø3.5x14mm	Screw	24 pcs
J		M4*18mm	Bolt	6 pcs
K			Handle	3 pcs
L		M4mm	Allen Key	1 pcs
M			Sticker	20 pcs
N		27*300mm	Drawer slider	3 set

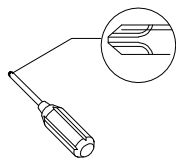



Philips head screwdriver required for assembly
(not included)

*The hardware quantities listed above are required for proper assembly.
Some extra hardware may also have been included.*

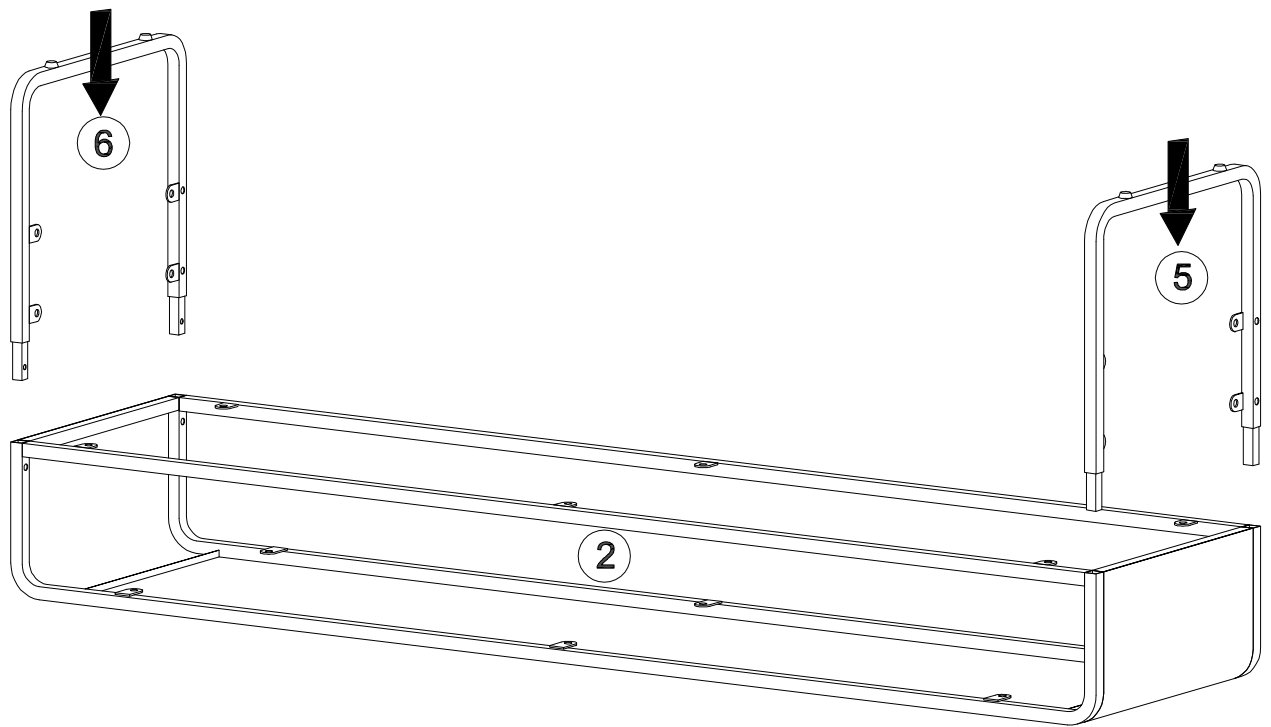
Step 1



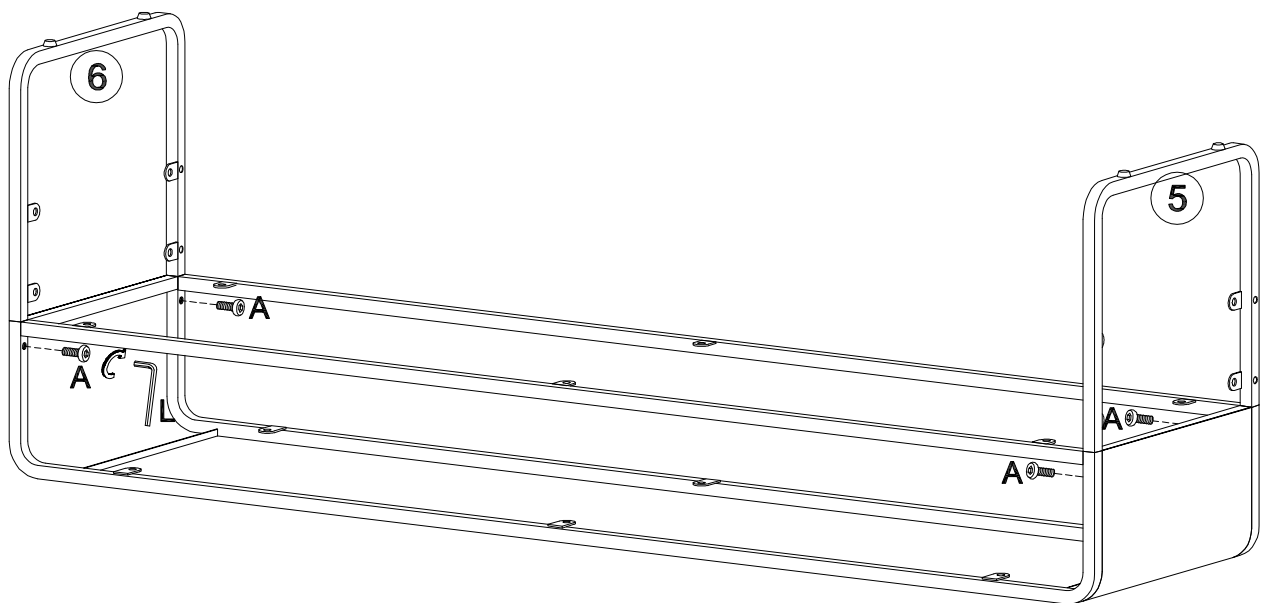

Step 2

A x 4	L x 1
	
Ø1/4"x12mm	4mm



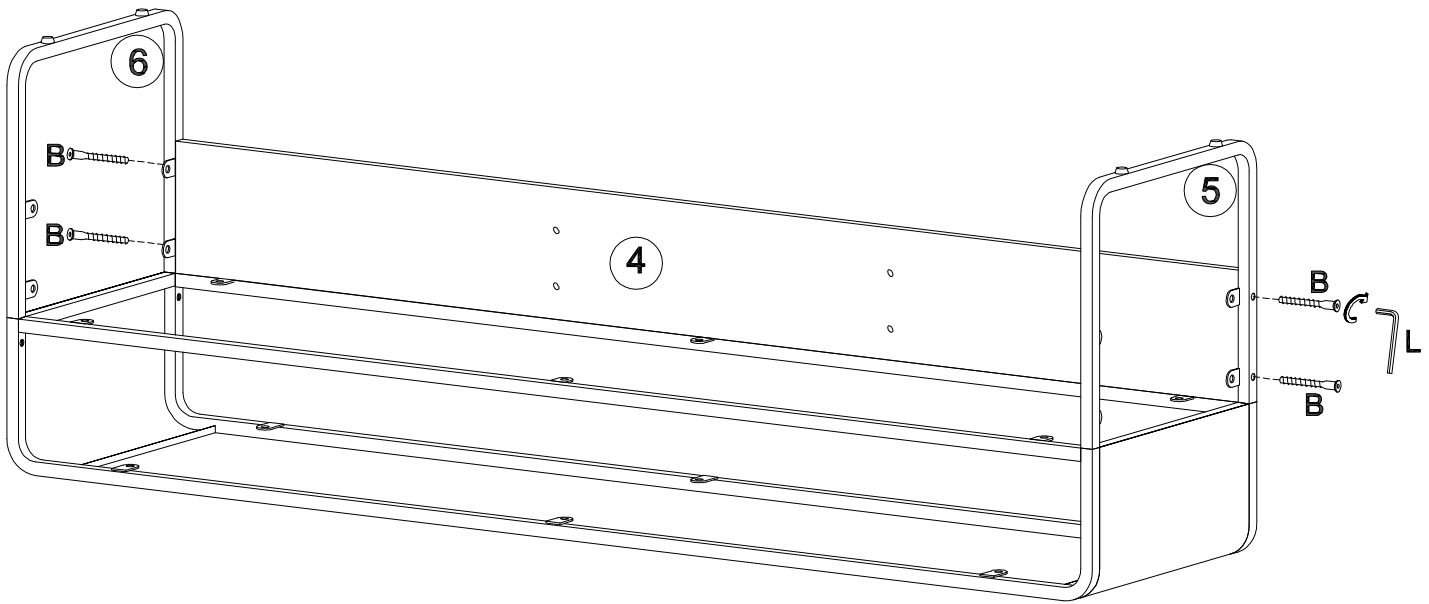

Step 3

B x 4	L x 1
	
Ø6x50mm	4mm







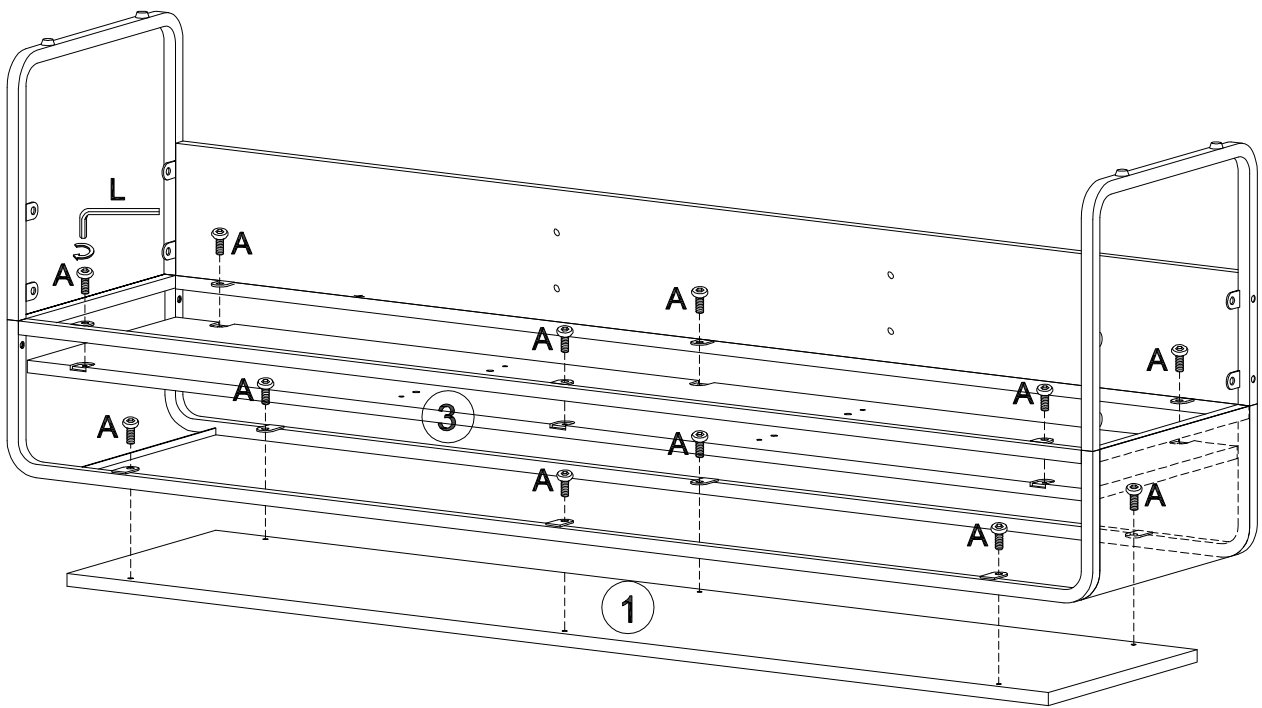

Step 4

A x 12	L x 1
	
Ø1/4"x12mm	4mm





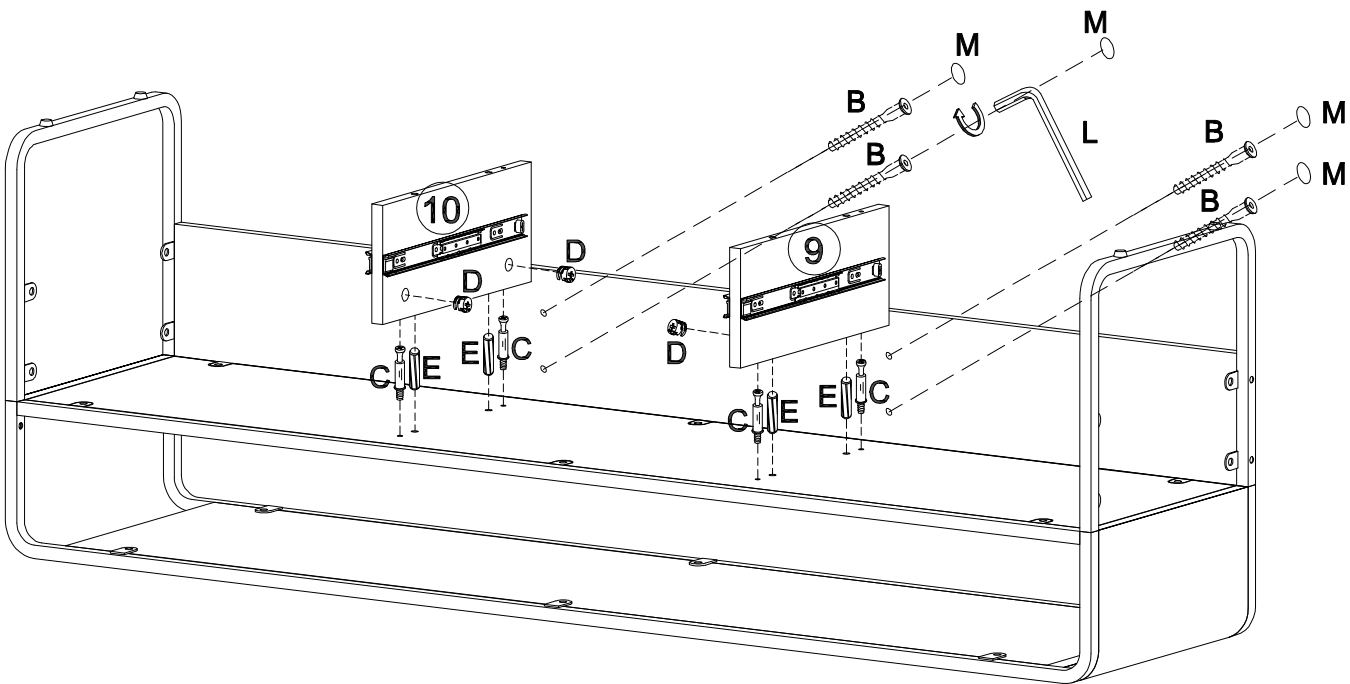

Step 7

B x 4	C x 4	D x 4	E x 4	L x 1	M x 4
					
Ø6x50mm	Ø6x35mm	Ø15x12mm	Ø8x30mm	4mm	



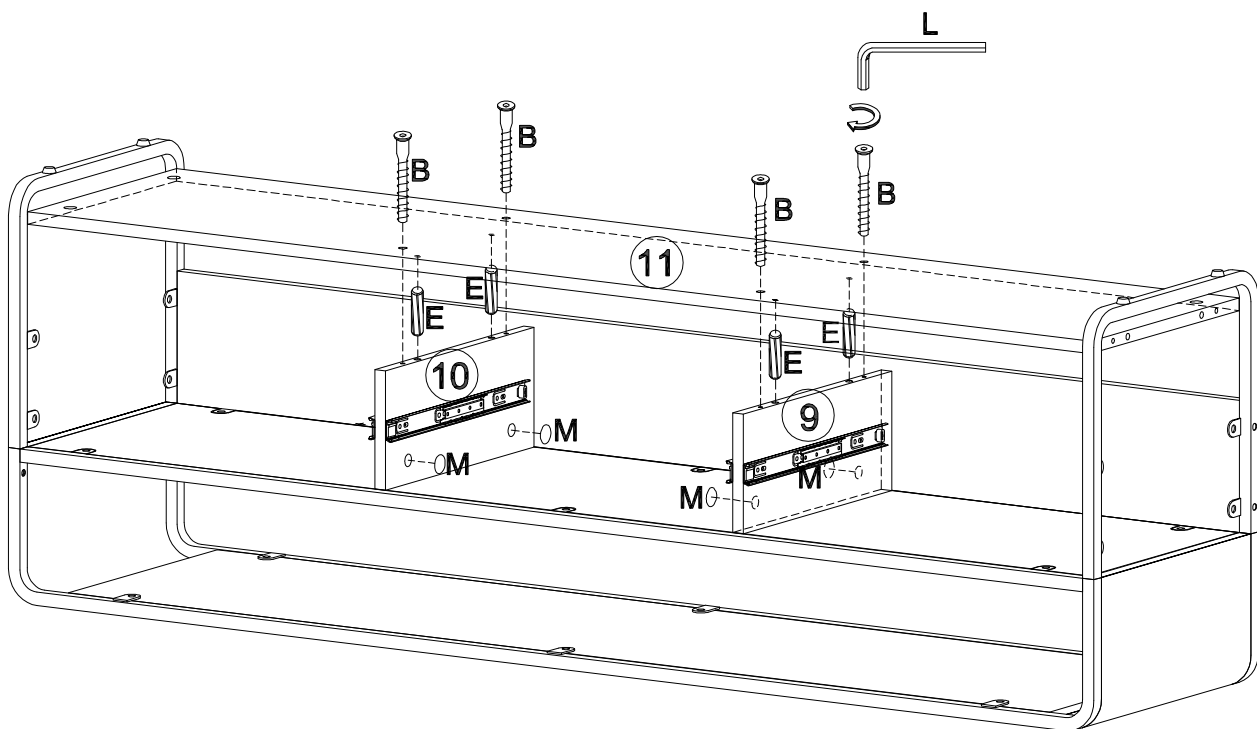

Step 8

B x 4	E x 4	L x 1	M x 4
			
Ø6x50mm	Ø8x30mm	4mm	



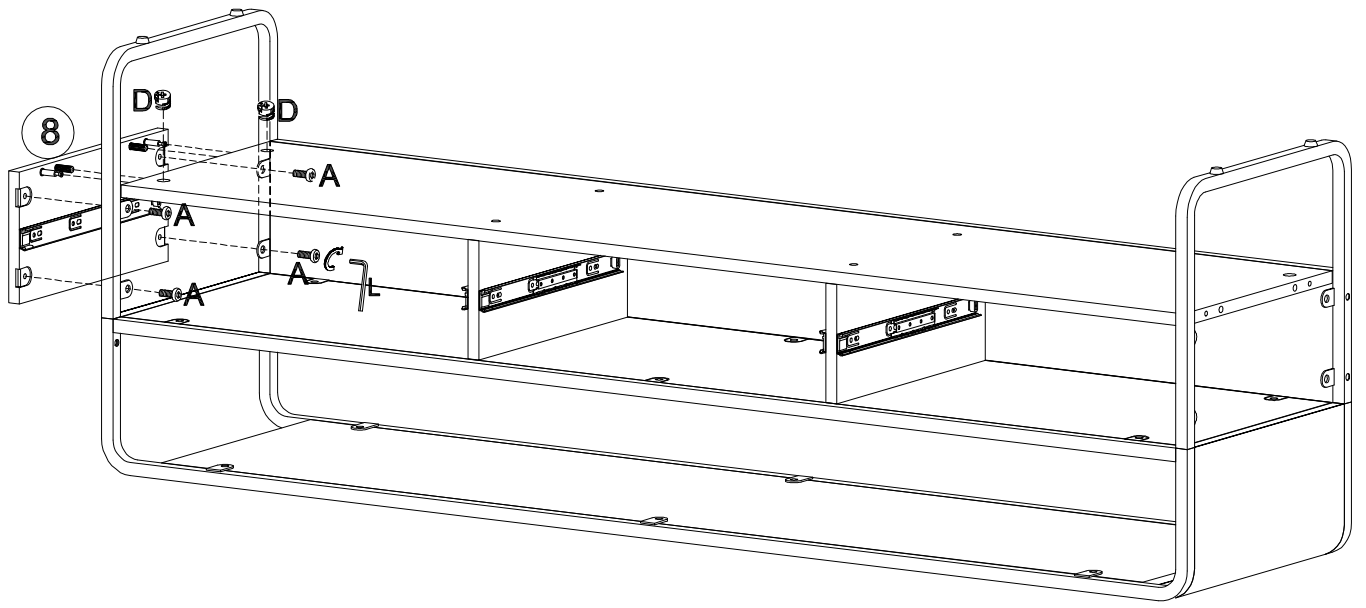

Step 9

A x 4	D x 2	L x 1
		
Ø1/4"x12mm	Ø15x12mm	4mm



Step 10

A x 4	D x 2	L x 1
		
Ø1/4"x12mm	Ø15x12mm	4mm

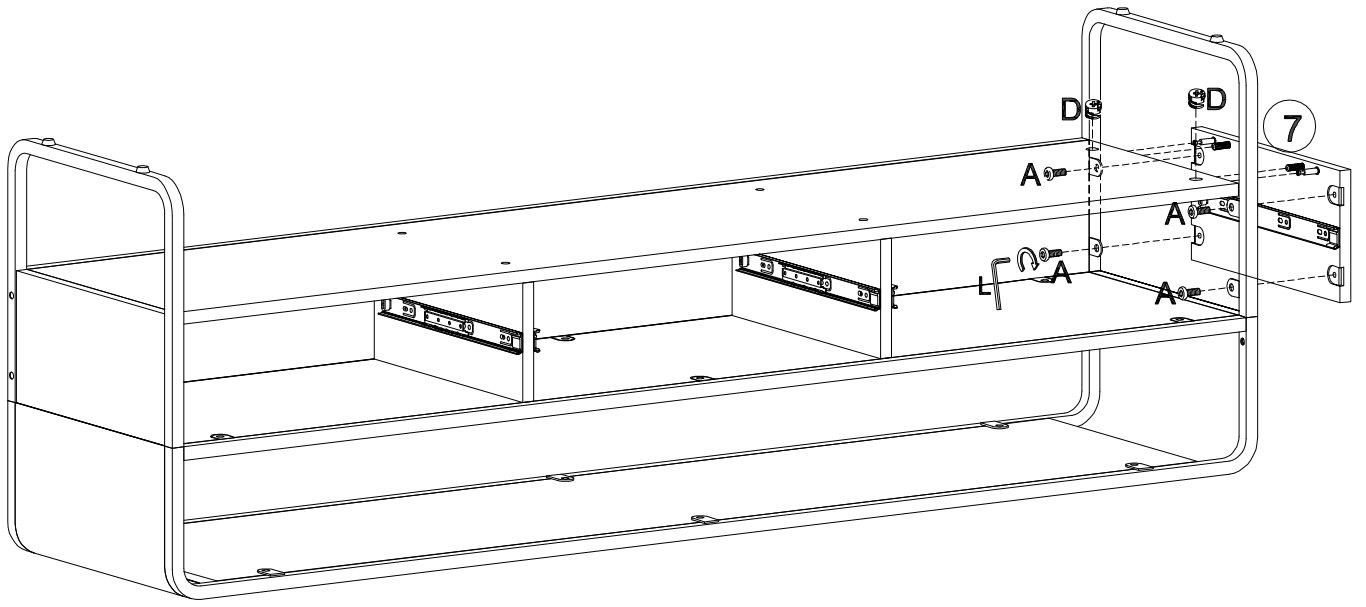

Step 11

C x 12

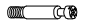

Ø6x35mm

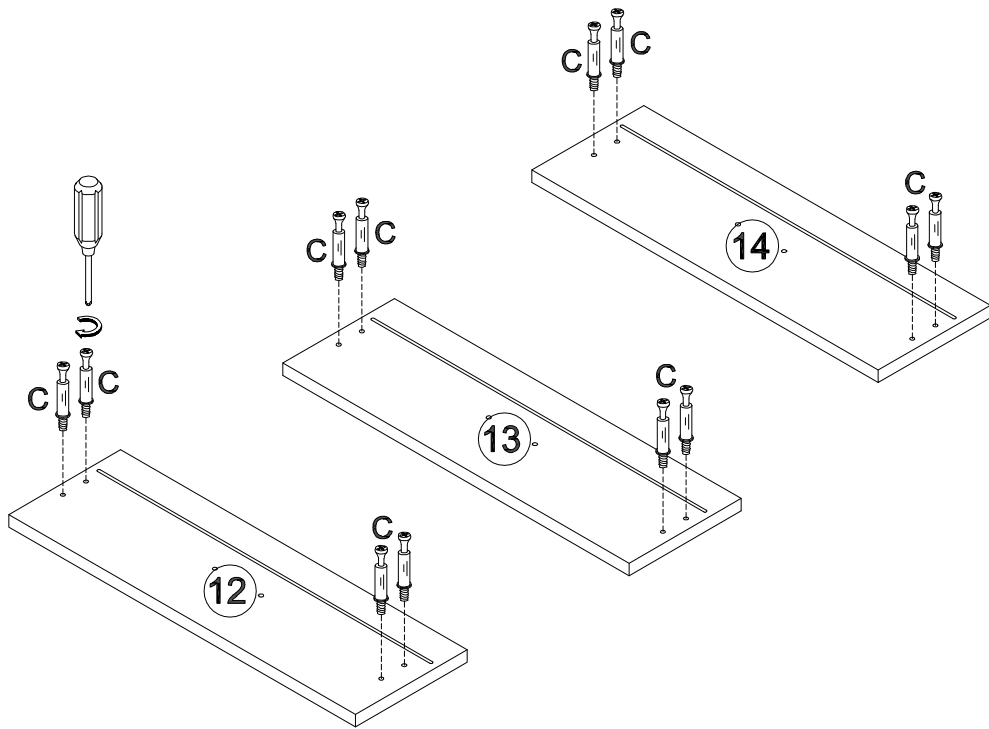

Step 12

F x 12

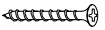

Ø4x30mm

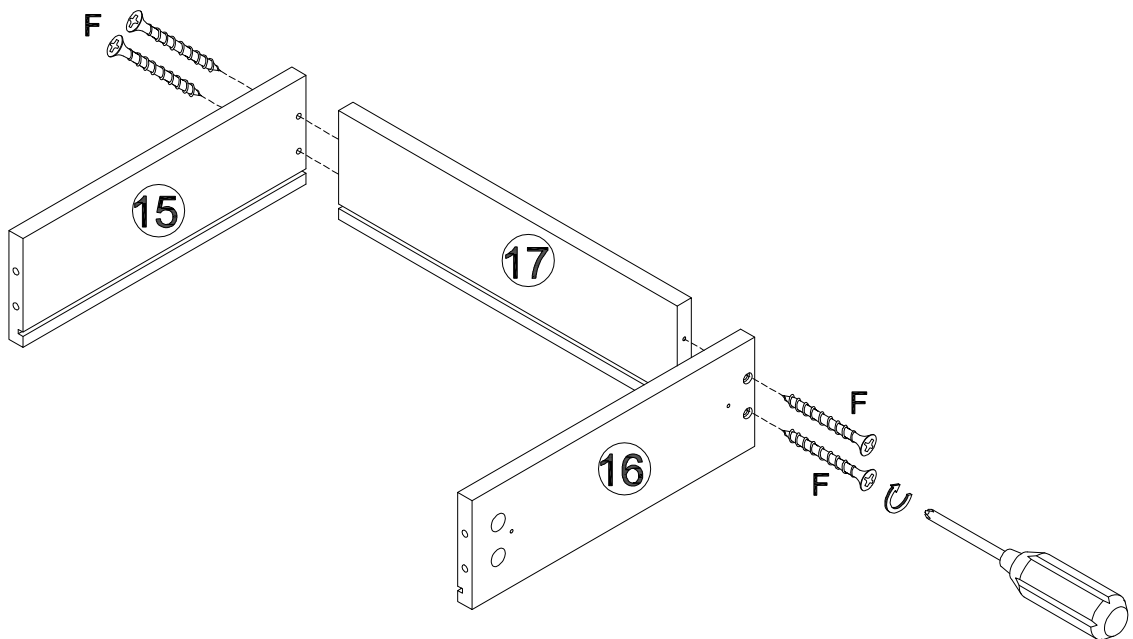

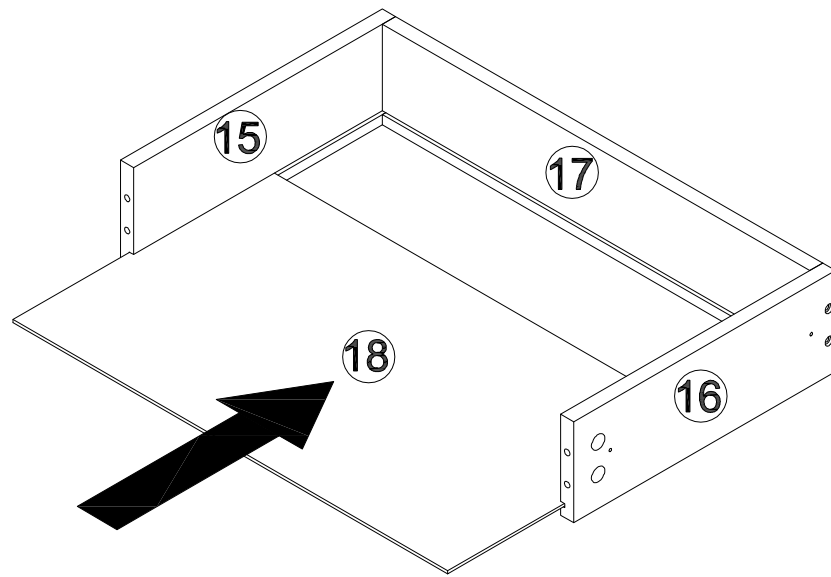

x3Pcs

Step 13



x3Pcs

Step 14

D x 12	J x 6	K x 3
 Ø15x12mm	 Ø4x18mm	

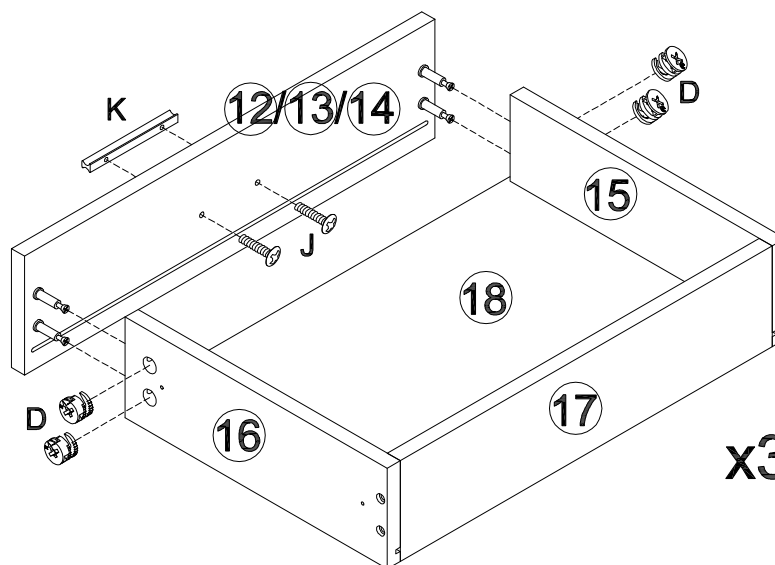

x3Pcs

Step 15

M x 12

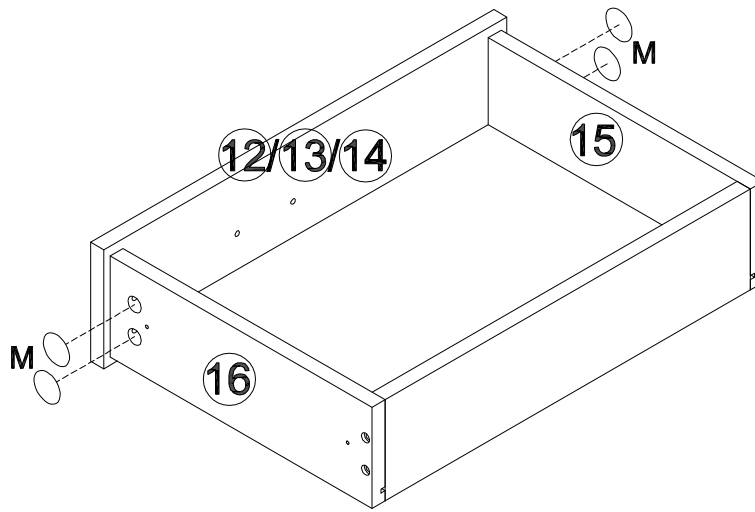

x3Pcs

Step 16

H x 12
N x 3

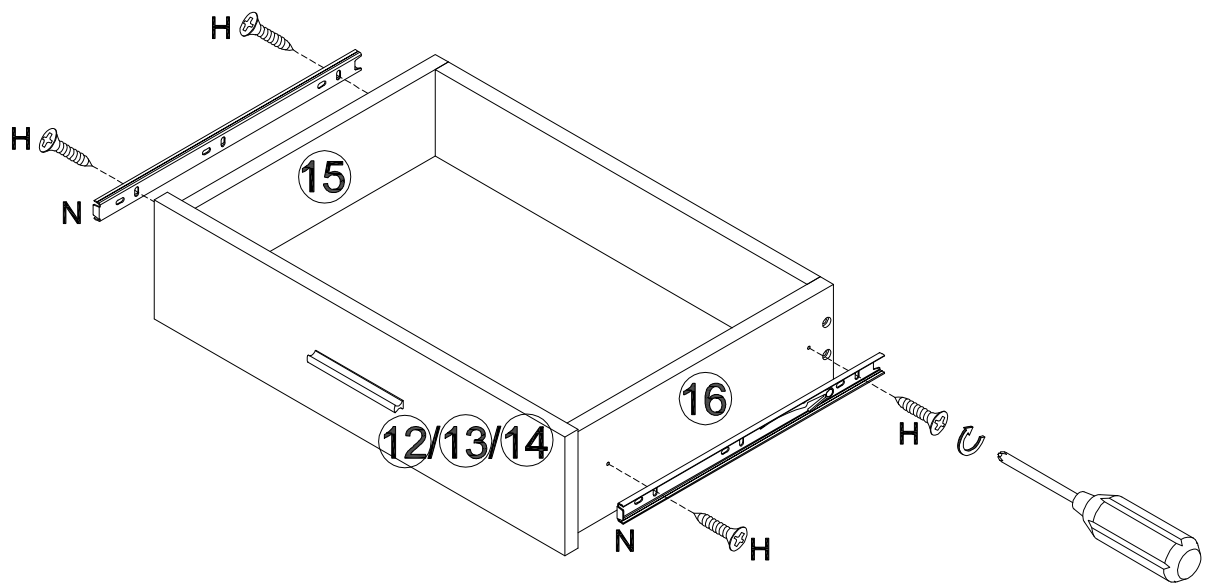

x3Pcs

Step 17

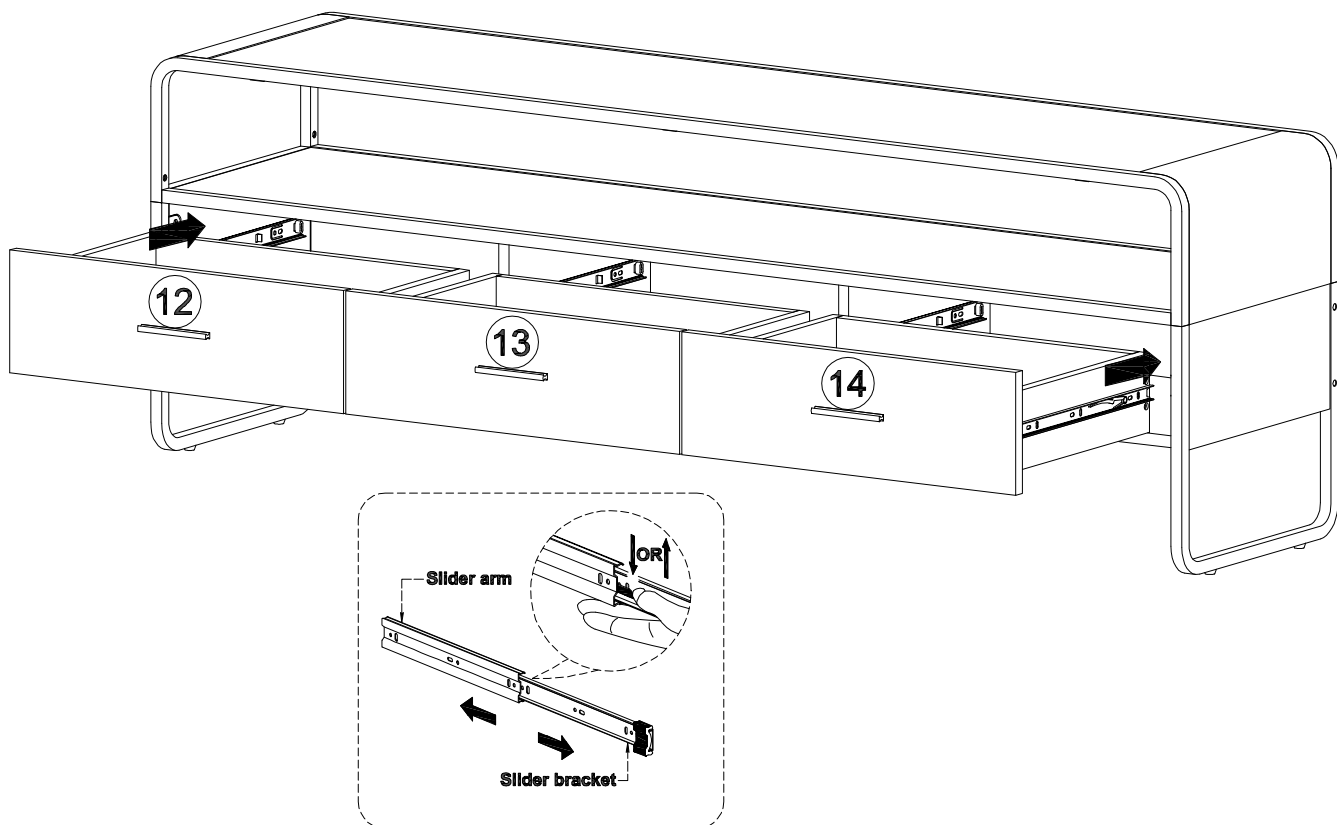

Step 18

