

TURANO

DEPLIANT FOR ASSEMBLY OF FEET

VERSION WITH ARM
PLANT - VIEW FROM ABOVE THE SOFA

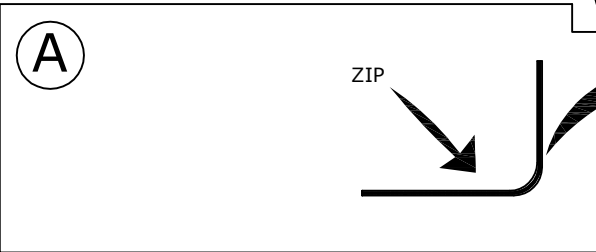
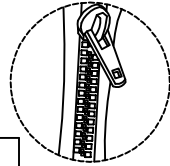

VERSION SECTIONAL
PLANT - VIEW FROM ABOVE THE SOFA

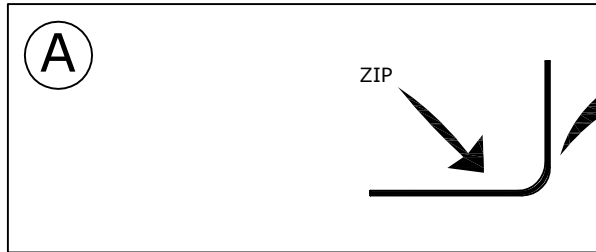
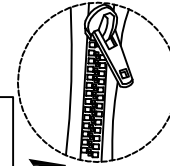

VERSION POUF
PLANT - VIEW FROM ABOVE THE SOFA

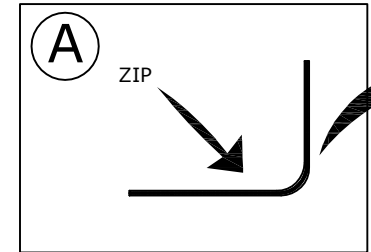
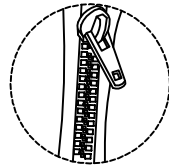

VERSION WITH ARM

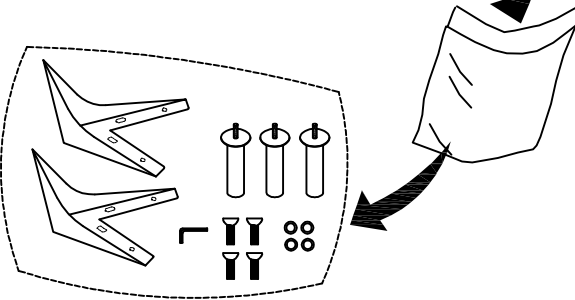
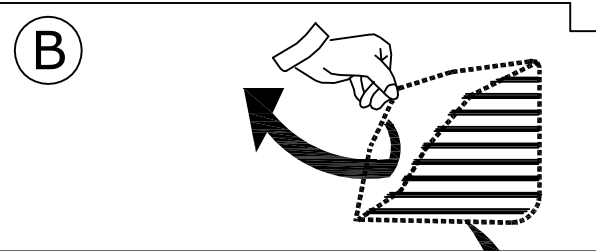

VERSION SECTIONAL

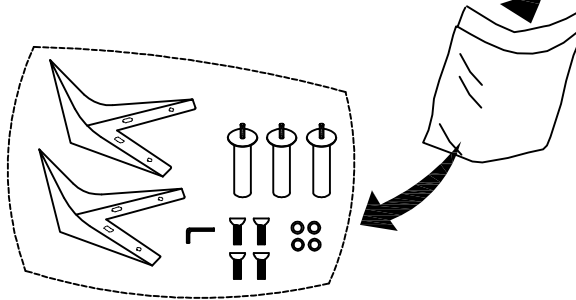
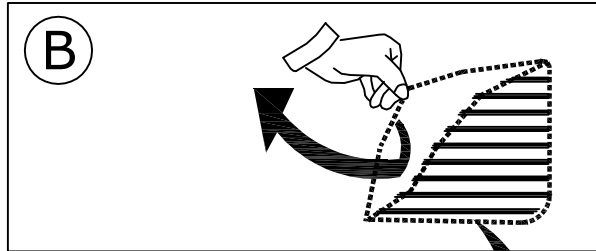

VERSION POUF

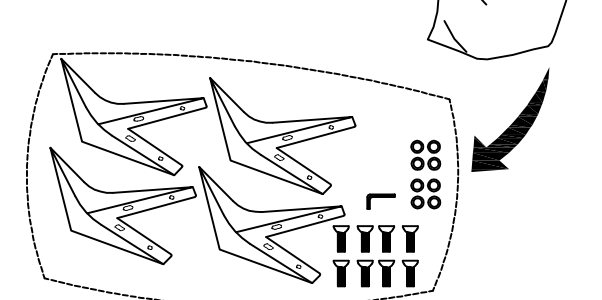
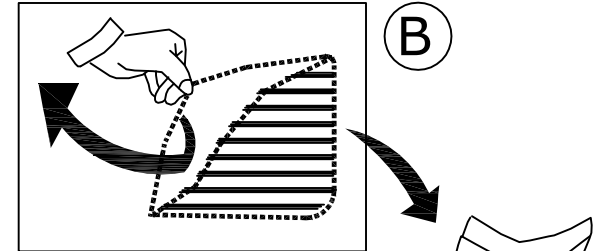

PACKET FOR VERSION
3 SEATER ONE ARM
(V031/V032)

PACKET FOR VERSION
SECTIONAL (V051/V052)

PACKET FOR VERSION
POUF (V001)

VERSION WITH ARM

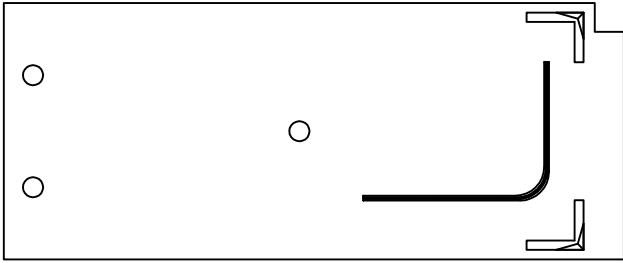

VERSION POUF

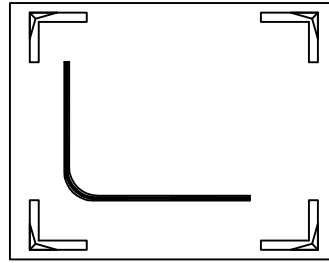

VERSION SECTIONAL

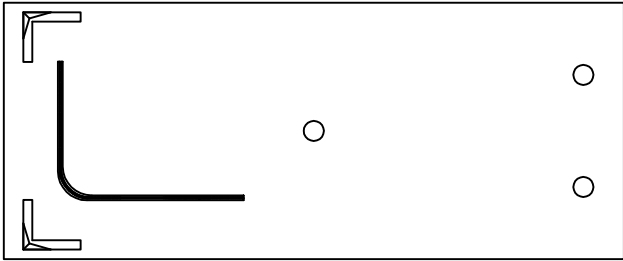

INSTRUCTION

Unpackage the sofa and turn it over. (A)

Open the zipper underside the sofa and pull the bag with the legs inside (B).

Unpackage the legs (C).

Position the leg in the position shown as a drawing, with threaded pin and hexagonal key.

Repeat this process for all the legs. Finally, screw the central legs where indicated (D)

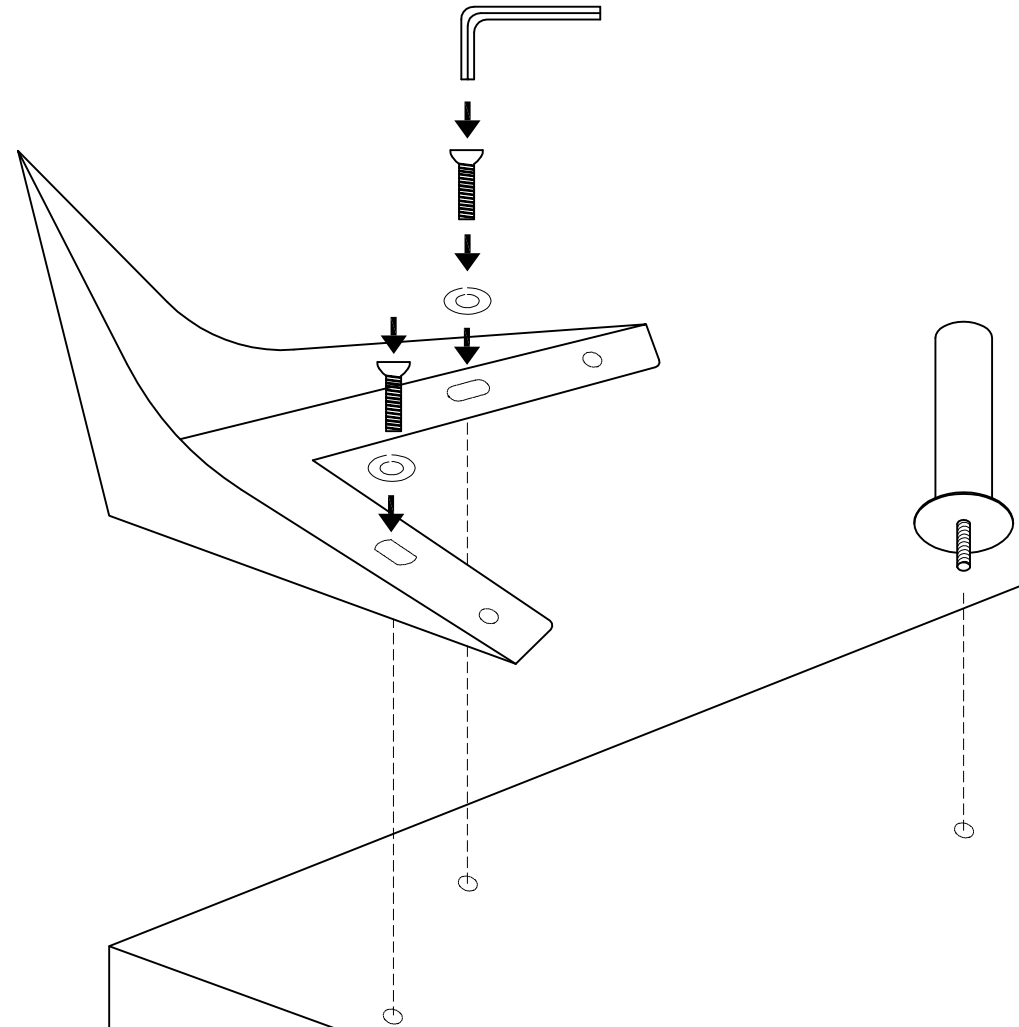

D

BACKREST CLOSED

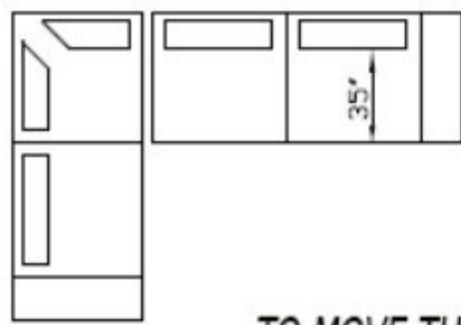

TO MOVE THE BACKREST TOWARDS THE FRONT, POSITION IN THE BACK OF THE SOFA AND SLIGHTLY PUSH THE BACKREST

BACKREST OPENED

