



ASSEMBLY INSTRUCTION

ITEM NO. : 91110&91111&91112&91113

NOTE: DON'T TIGHTEN SCREWS UNTIL COMPLETELY ASSEMBLED !

HARDWARE LIST		
A	 Ø1/4"*1-1/4"	4 PCS
B	 Ø1/4"	1 PC
C	 8# x1"	2 PCS

STEP#1

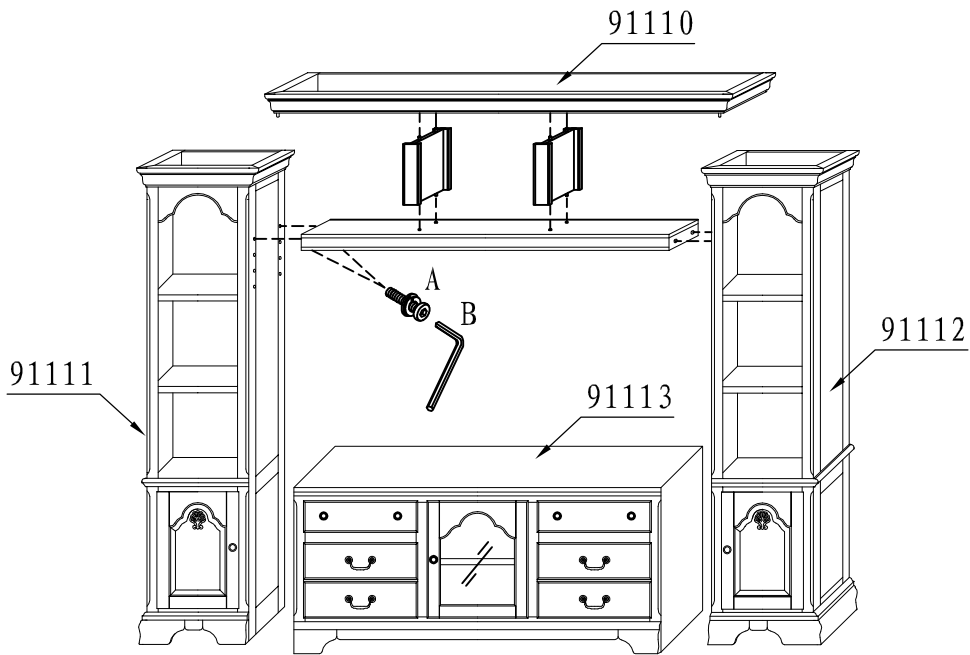

STEP#2

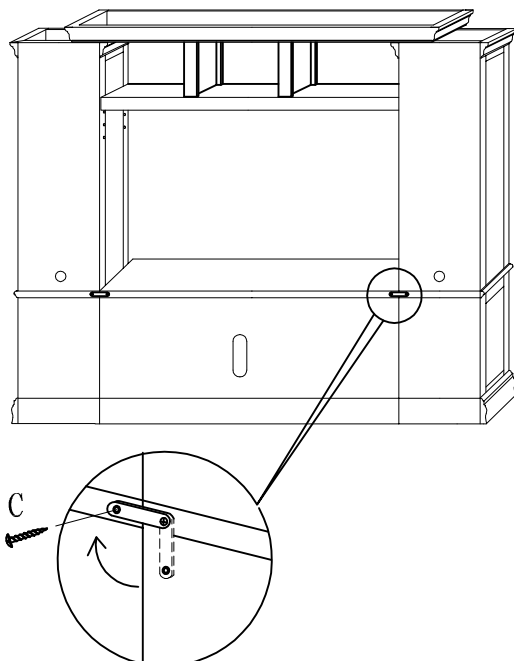

STEP#3

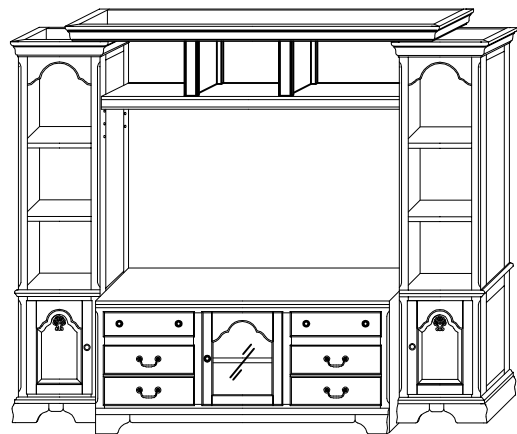

Assembly completed