



## ASSEMBLY INSTRUCTIONS

Item No: #39090

#BD00379

#BD00380



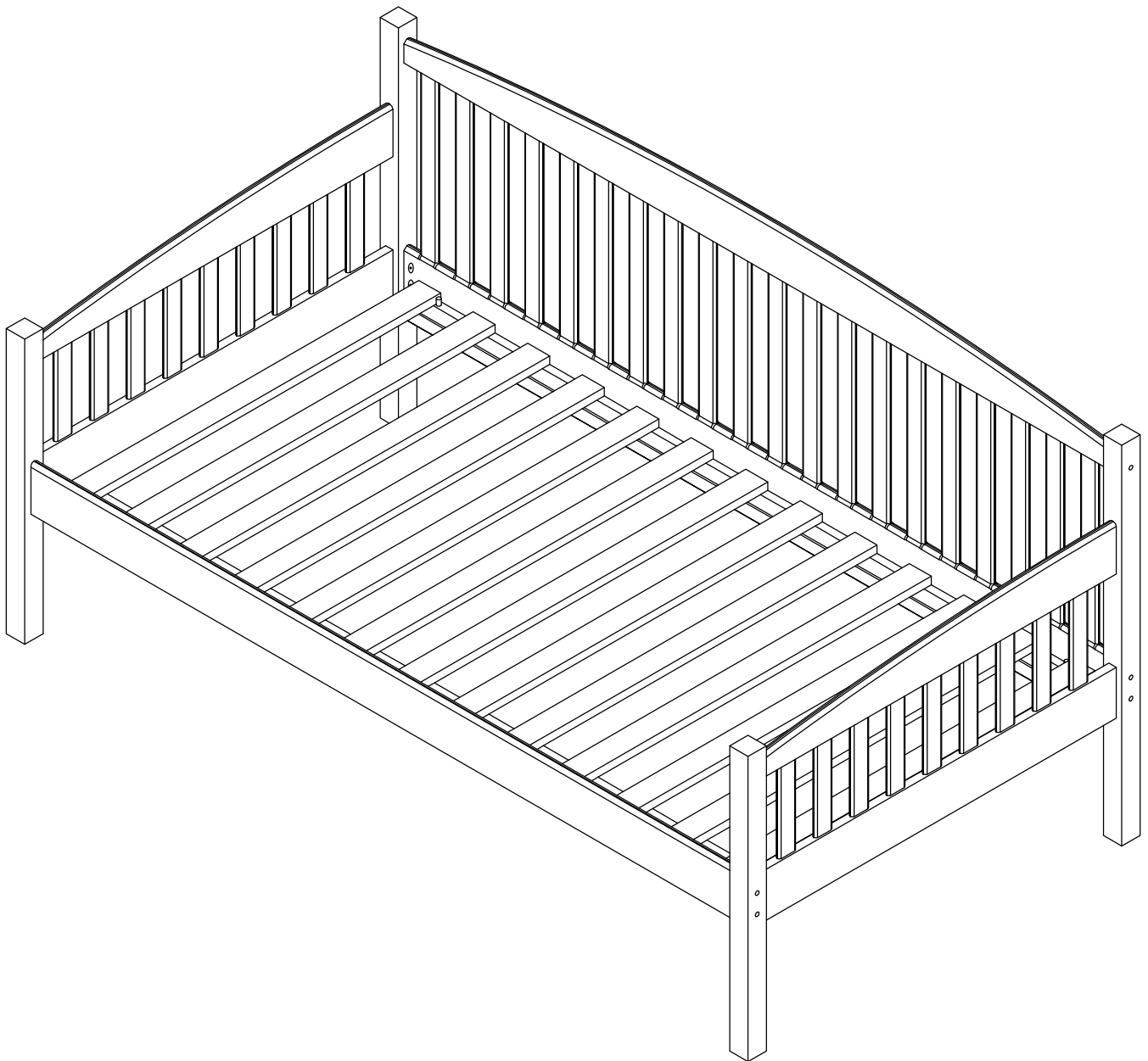

\*\*\* Thank you for purchasing this quality product. Be sure to check all packing materials carefully for small parts which may have come loose inside the carton during shipment. Identify and count all parts and compare with parts list below.

\*\*\* Assemble product on a flat, soft surface such as a carpet or cloth to prevent scratching the finish. Read all instruction and study the drawings carefully before starting the assembly process.







Do not tighten screws until each step is completed.

## PARTS LIST

No	Diagram	Description	Q'ty
1		Right Headboard	1 pc
2		Left Headboard	1 pc
3		Back Rail Panel	1 pc
4		Front Rail	1 pc
5		Slats (13pcs=1set)	1 set





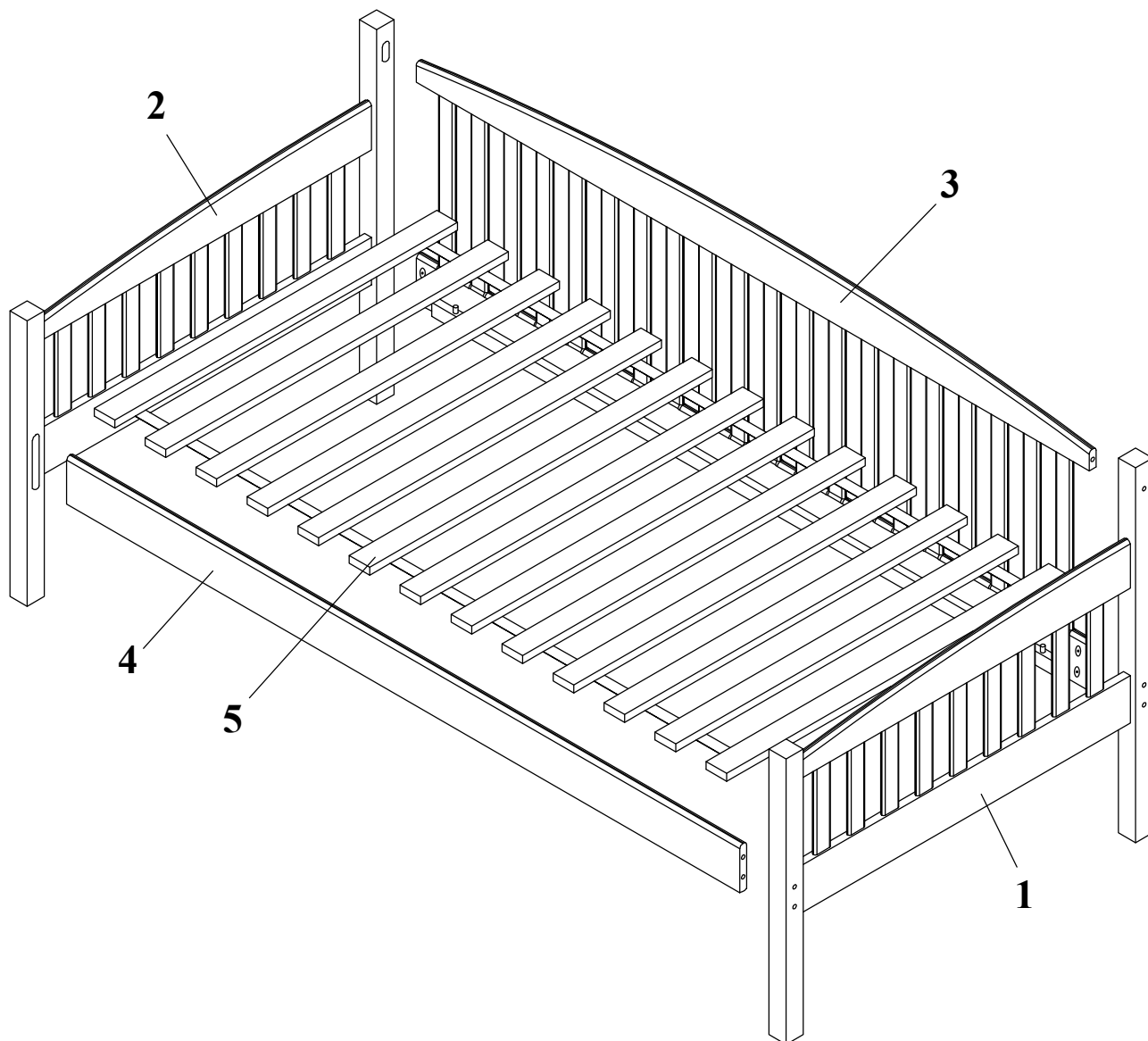

## HARDWARE LIST

No	Diagram	Description	Q'ty
A		Bolt - 6.3 x 100(mm)	10 pcs
B		Half Round Nut	10 pcs
C		Screw - 4 x 30(mm)	26 pcs
D		Allen Wrench	1 pc

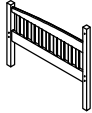

# #39090 & BD00379 & BD00380

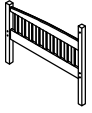
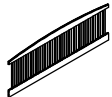
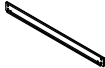
is packed in 2 cases

Carton	Disignation	Part		Hardware
<b>Item:</b> <b>39090HF</b> <b>BD00379-1</b> <b>BD00380-1</b>	Right Hedboard x 1pc	#1		 A: Bolt - 6.3 x 100(mm) x 10pcs  B: Half Round Nut x 10pcs  C: Screw - 4 x 30(mm) x 26pcs  D: Allen Wrench x 1pc
	Left Headboard x 1pc	#2		
<b>Item:</b> <b>39091RL</b> <b>BD00379-2</b> <b>BD00380-2</b>	Back Rail Pannel x 1pc	#3		
	Front Rail x 1pc	#4		
	Slats (13pcs=1set) x 2pcs	#5		

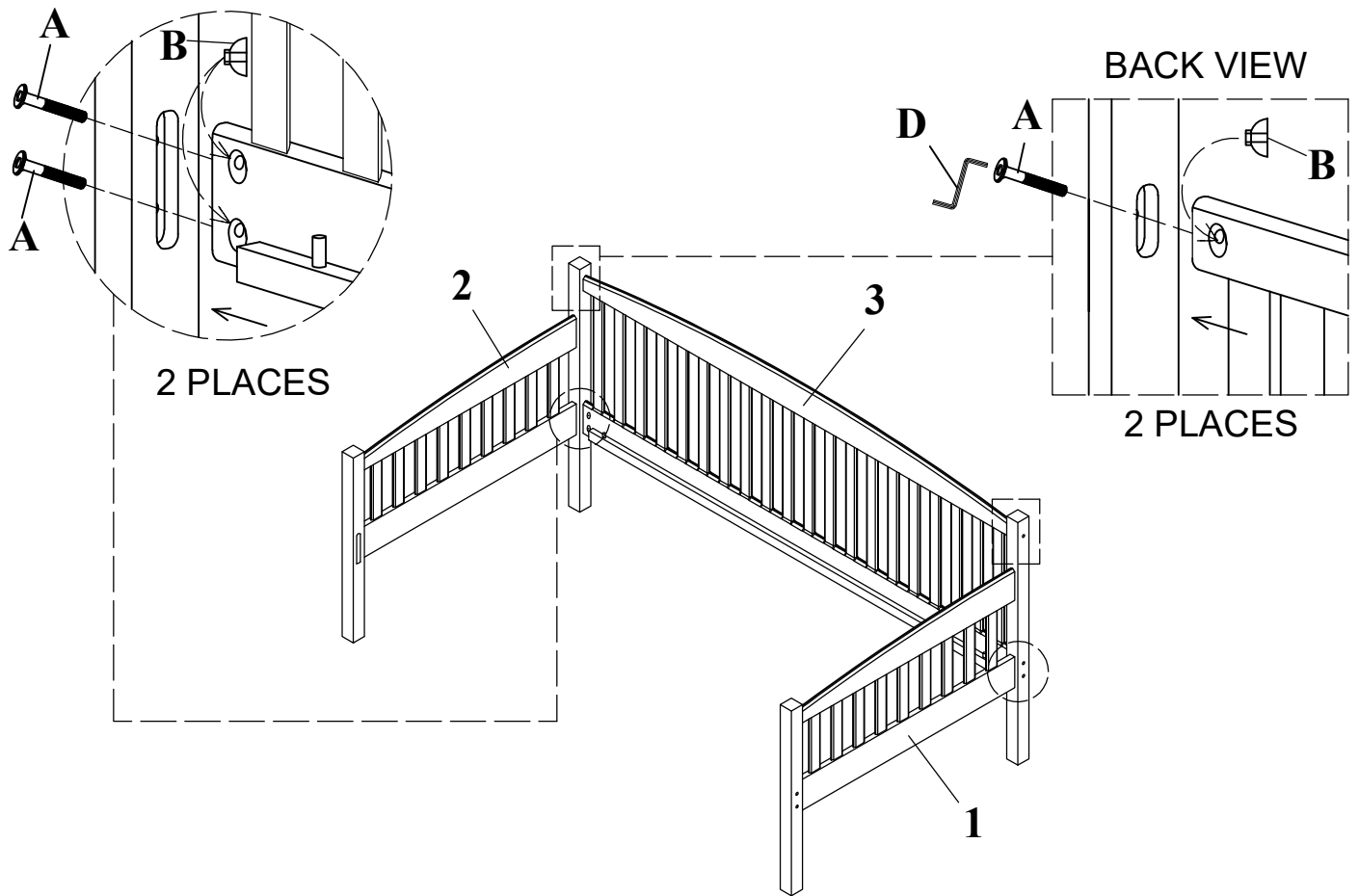

**STEP 1: Left & Right Headboard Assembly With Back Panel**

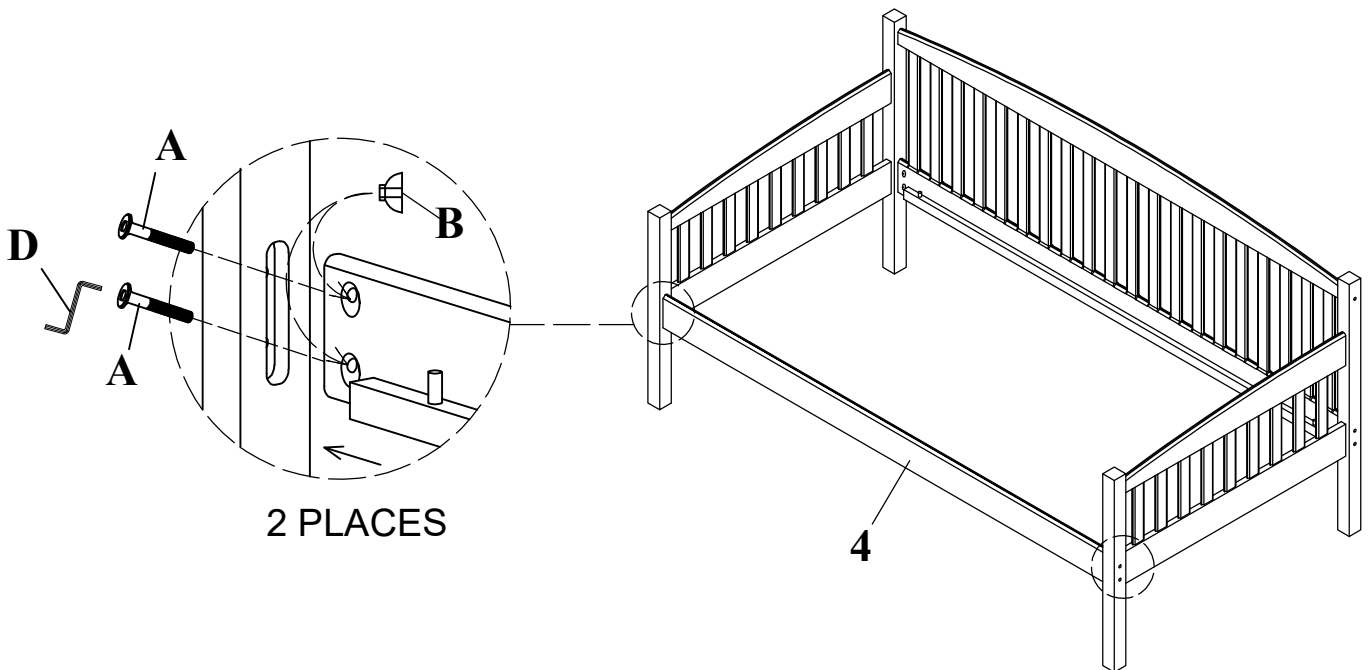

**STEP 2: Front Rail Assembly**

