

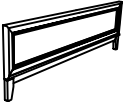





# **ASSEMBLY INSTRUCTION FOR ACME FURNITURE**





## **MODEL # 28447EK-HF /28448EK-R/28427EK-HF/28428EK-R**

Thank you for purchasing the quality product. Be sure to check all packing material carefully for small parts which may have come loose inside the carton during shipment. Separate, identify and count all parts and metal hardware. Compare with all parts list to be sure all parts are present. If any part(s) are missing or damaged, please contact your local furniture dealer. For efficient and speedy service, please indicate the model number and code letter of part(s) needed.

\*\*\*Do not fully tighten screws until fully assembled\*\*\*

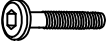
COMPONENT PARTS		
DESCRIPTION	PART NAME	Q'TY (PCS)
①	HEADBOARD 	1
②	FOOTBOARD 	1
③	HEADBOARG LEG (LEFT) 	1
④	HEADBOARG LEG (RIGHT) 	1
⑤	SIDE RAIL 	2
⑥	BED SLAT 	4
⑦	BED SLAT SUPPORT 	8

# HARDWARE REQUIRED (BOX OF HEADBOARD)

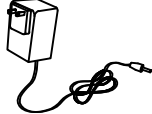
- (A)  BOLT 1/4" x 1 3/16" - 6 PCS
- (B)  SPRING WASHER 1/4" - 6 PCS
- (C)  FLAT WASHER 1/4" - 6 PCS
- (D)  ALLEN KEY M4 - 1 PC
- (E)  ALLEN KEY M5 - 1 PC
- (F)  FLATHEAD CHIPBOARD SCREW 5/32" x 1 2/8" - 8 PCS
- (G)  ADAPTOR - 1 PC

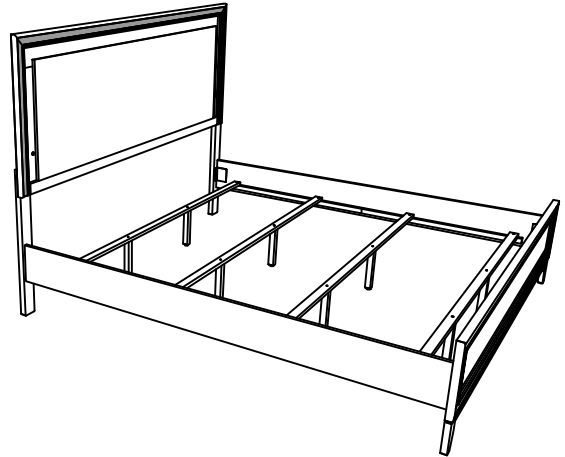

**Attention:**

\*\*\* Some number parts listed in the instruction sheet may not be in parts bags as they already be assembled. Caerfully check parts and packing materials prior to ordering replacements.

## How to assemble:

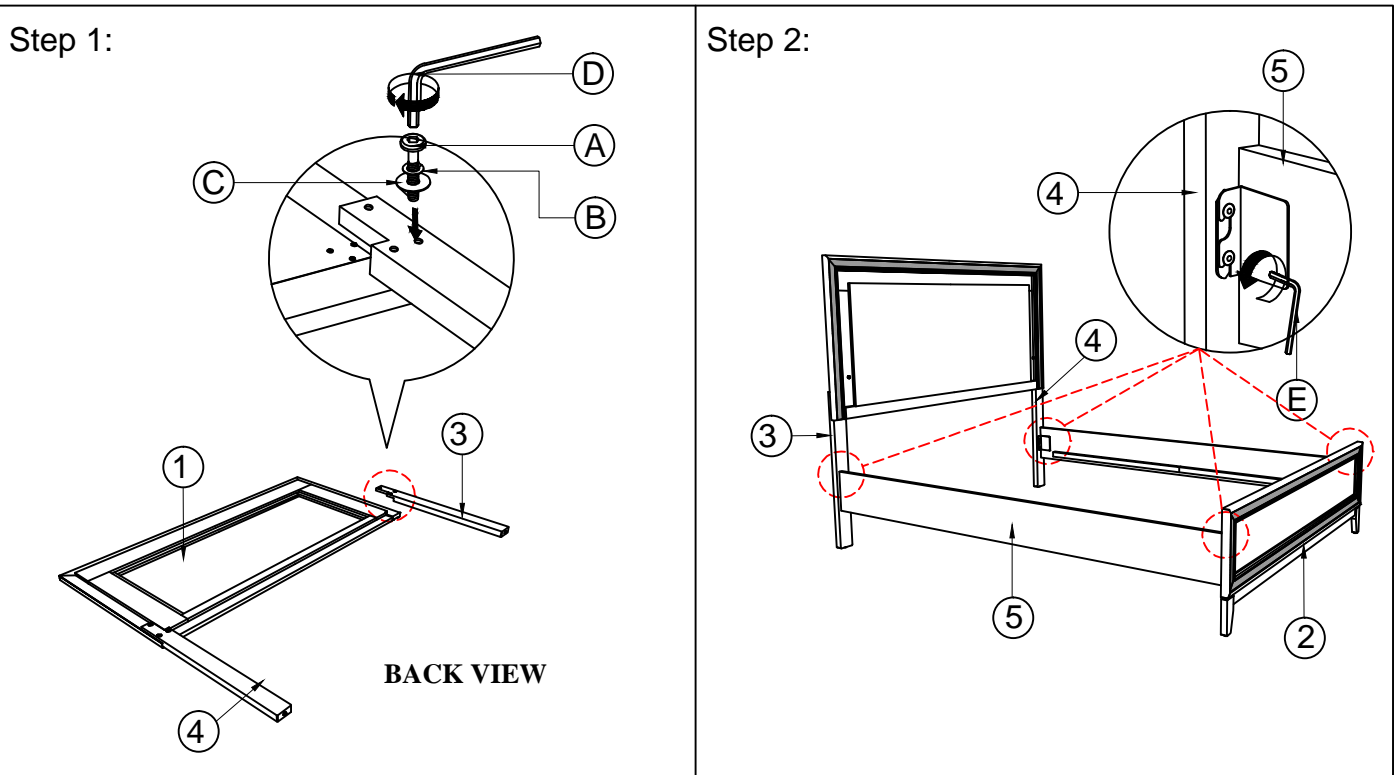

# How to assemble:

Step 3:

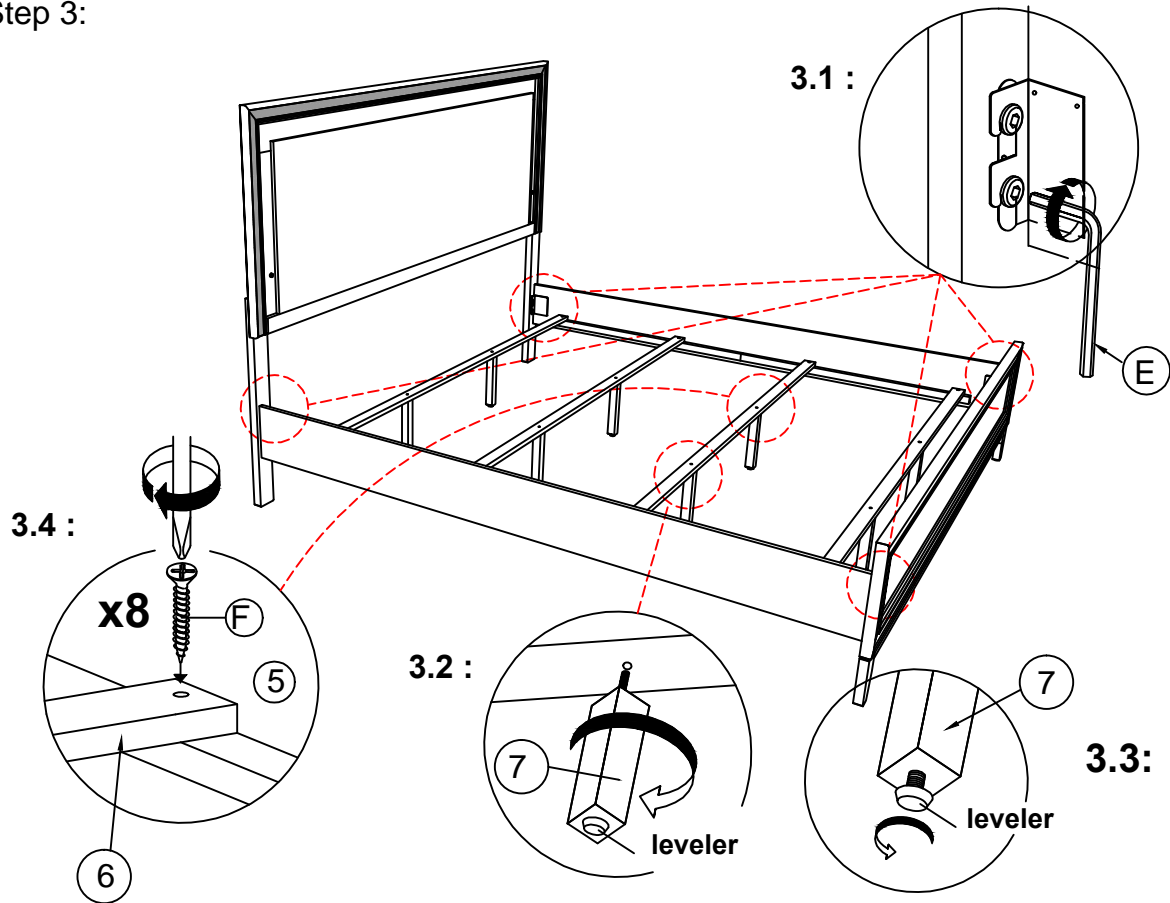

Step 4:

COMPLETE

REMARK!!  
REMOVE THE  
ADAPTOR FROM THE  
BOX WITH RED LABEL

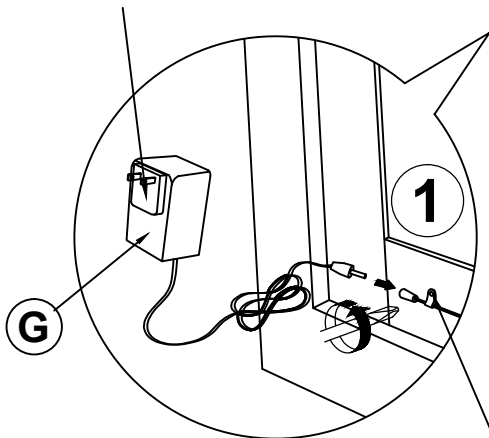

LOOSEN THE SCREW  
TO CONNECT

