





ASSEMBLY INSTRUCTION FOR ACME FURNITURE

MODEL#56927 CHAIR

Thank you for purchasing this quality product. Be sure to check all packing material carefully for small parts which may have come loose inside the carton during shipment. Separate, identify and count all parts and metal hardware. Compare with parts list to be sure all parts are present. If any part(s) are missing or damaged, please contact your local furniture dealer. For efficient and speedy service, please indicate the model number and code letter of part(s) needed.

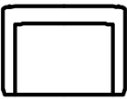
***** Do not fully tighten screws until fully assembled *****

| COMPONENT PARTS | | | |
|------------------------|---|------------------|-----------|
| DESCRIPTION | DRAWING | PART NAME | Q'TY(PCS) |
| #1 |  | SEAT | 1 |
| #2 |  | LEFT ARMREST | 1 |
| #3 |  | RIGHT ARMREST | 1 |
| #4 |  | BACKREST | 1 |
| #5 |  | BACKREST CUSHION | 1 |
| #6 |  | LEG | 4 |

HARDWARES REQUIRED

#A  BOLT M8*20 — 8PCS

#B  ALLEN KEY — 1PCS

Attention:

*** Mattresses not included.

*** Some number parts listed on the instruction sheet may not be in parts bag as they may already be assembled.

Carefully check parts and packing materials prior to ordering replacements.

Please follow the drawings below to assemble the model.

Step.1

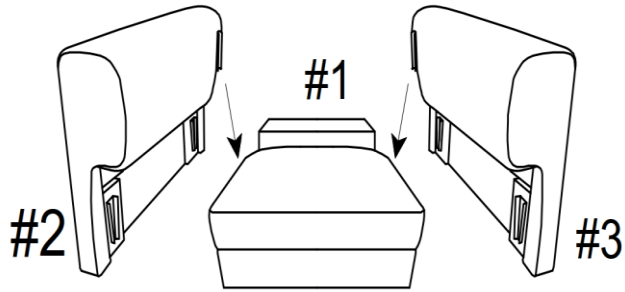

Step.2

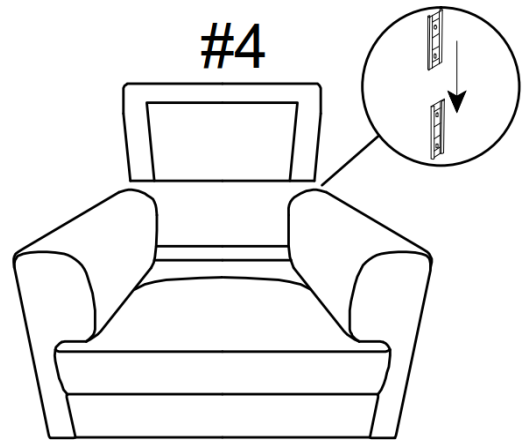

Step.3

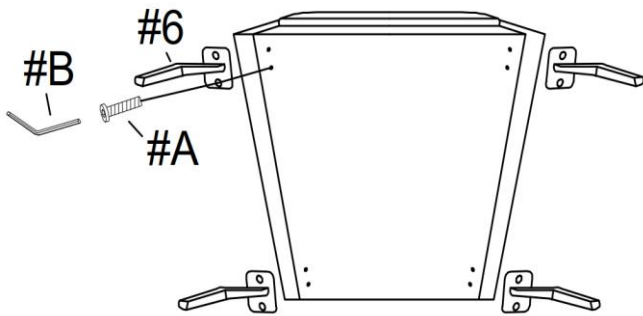

Step.4

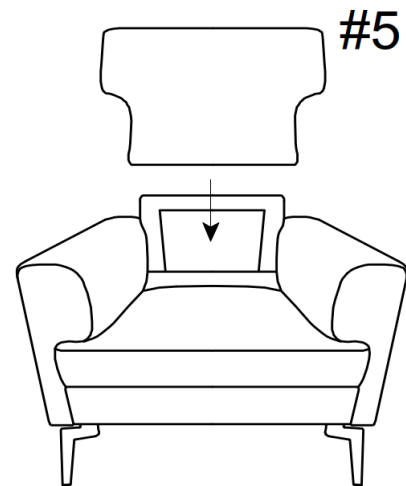

Step.5

