

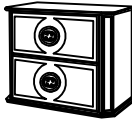

ASSEMBLY INSTRUCTION FOR ACME FURNITURE





MODEL#28813

Thank you for purchasing the quality product. Be sure to check all packing material carefully for small parts which may have come loose inside the carton during shipment. Separate, identify and count all parts and metal hardware. Compare with all parts list to be sure all parts are present. If any part(s) are missing or damaged, please contact your local furniture dealer. For efficient and speedy service, please indicate the model number and code letter of part(s) needed.

***** Do not fully tighten screws until fully assembled *****

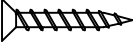
COMPONENT PARTS		
DESCRIPTION	PART NAME	Q'TY (PCS)
①	Nightstand 	1
②	Legs 	4

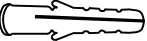
HARDWARE REQUIRED

Ⓐ		Fasten unit	44mmX20mm	2	PCS
Ⓑ		Long Screw	Ø7mmX38mm	2	PCS
Ⓒ		Short Screw	Ø6mmX16mm	2	PCS
Ⓓ		Shrink bolt	Ø5/16"X1-1/2"	2	PCS
Ⓔ		Safty belt	8mmX250mm	1	PCS

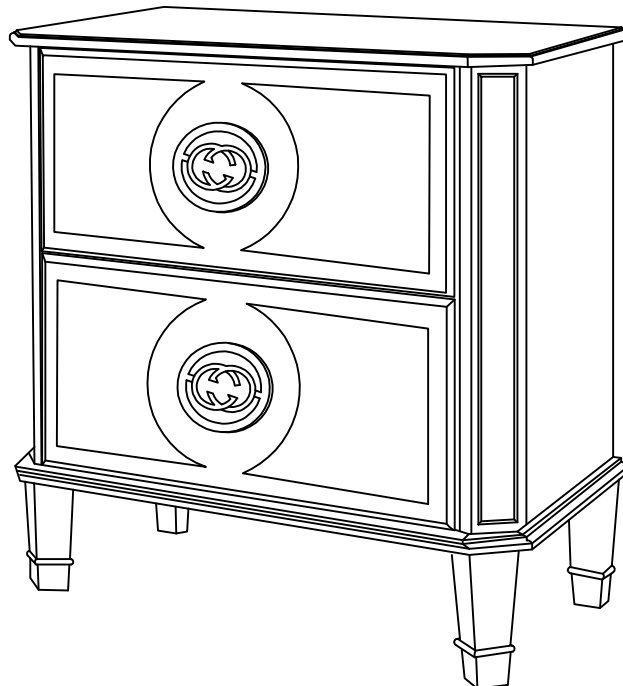

Attention

***** Some number parts listed on the instruction sheet may not be in parts bag as they may already be assembled. Carefully check parts and packing materials prior to ordering replacements.**

How to assemble:

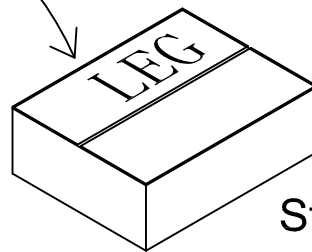
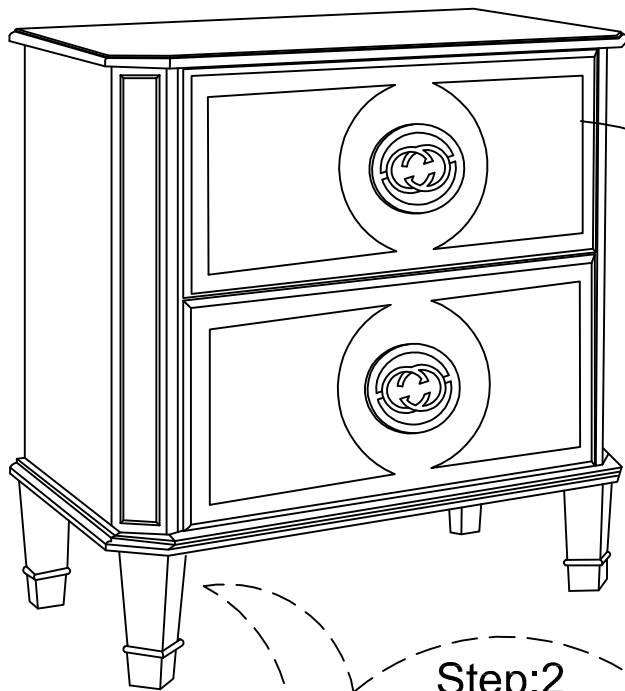

Step:1

legs are include inside drawer

Step:2

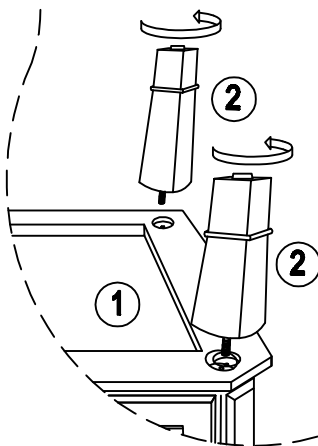

Step:4

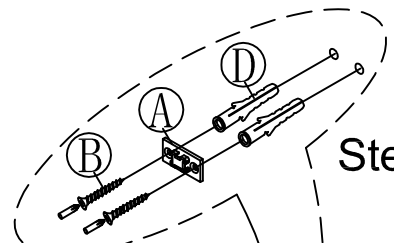

Step:3

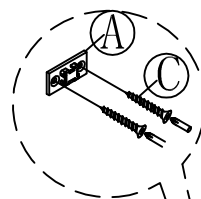

Step:5

