

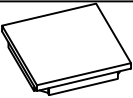

# ASSEMBLY INSTRUCTIONS FOR ACME FURNITURE



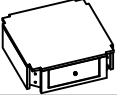

## MODEL#87102 END TABLE

Thank you for purchasing this quality product. Be sure to check all packing material carefully for small parts which may have come loose inside the carton during shipment. Identify and count all parts and metal hardware. Compare with the parts list to be sure all parts are present. If any part(s) are missing or damaged, please contact your local furniture dealer. For efficient and speedy service, please indicate the model number and code letter of part(s) needed.

**\*\*\* Do not fully tighten screws until fully assembled \*\*\***

<b>COMPONENT PARTS</b>		
<b>DESCRIPTION</b>	<b>PART NAME</b>	<b>QTY(PCS)</b>
<b>①</b>	<b>TOP Panel</b> 	<b>1</b>
<b>②</b>	<b>Leg</b> 	<b>4</b>
<b>③</b>	<b>BOTTOM FRAME</b> 	<b>1</b>

### HARDWARE REQUIRED

<b>(A)</b>		BOLT	Ø5/16"*2"	12 PCS
<b>(B)</b>		LOCK WASHER	Ø5/16"	12 PCS
<b>(C)</b>		FLAT WASHER	Ø5/16"*19mm	12 PCS
<b>(D)</b>		ALLEN KEY	5MM	1 PCS

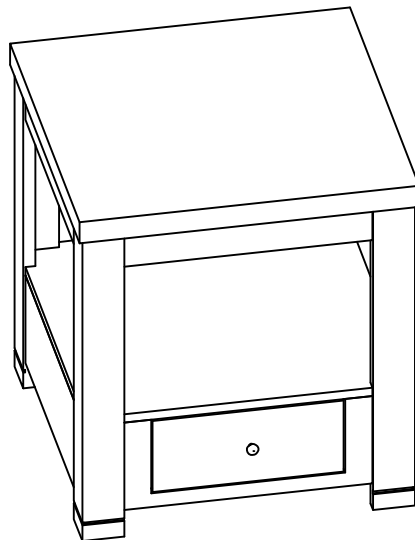

**Attention:**

**\*\*\* Some number parts listed on the instruction sheet may not be in parts bag as they may already be assembled. Carefully check parts and packing materials prior to ordering replacements.**

# How to assemble:

## STEP 1

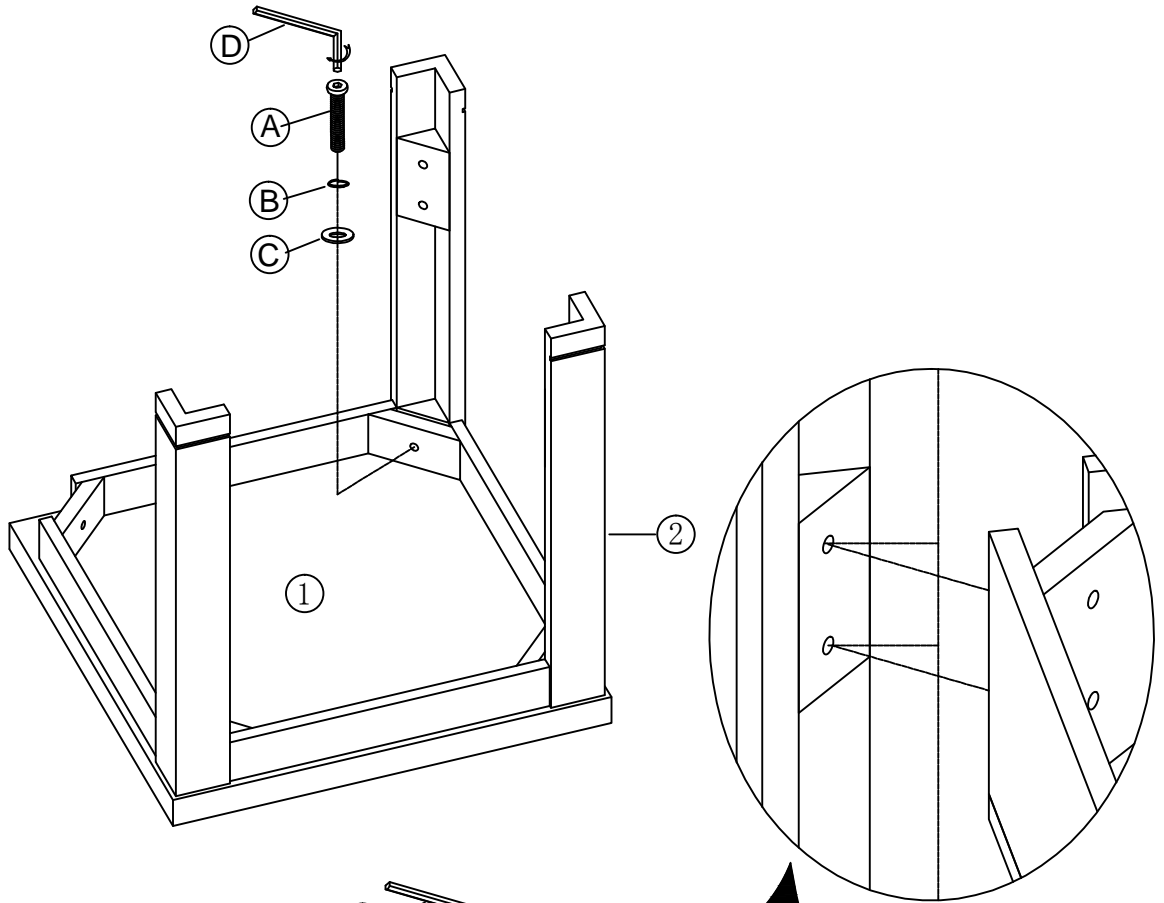

## STEP 2

