





ASSEMBLY INSTRUCTION FOR ACME FURNITURE

MODEL#52775/56650/56655/56660

Thank you for purchasing the quality product. Be sure to check all packing material carefully for small parts which may have come loose inside the carton during shipment. Separate, identify and count all parts and metal hardware. Compare with all parts list to be sure all parts are present. If any part(s) are missing or damaged, please contact your local furniture dealer. For efficient and speedy service, please indicate the model number and code letter of part(s) needed.

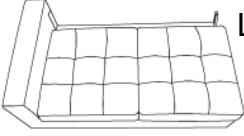
*** Do not fully tighten screws until fully assembled***

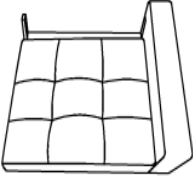
Parts List

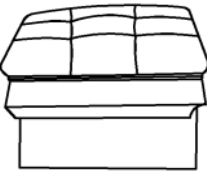
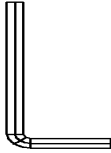
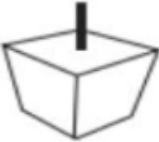
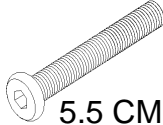
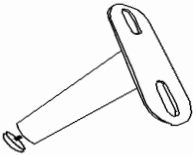
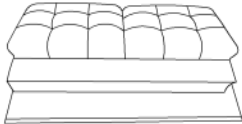
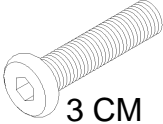
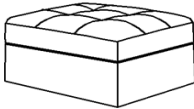
1  LAF LOVE SEAT BASE 1 PC	G  6 PCS
2  RAF CHAIR SEAT BASE 1 PC	H  6 PCS
3  CHAIR BACK REST 1 PC	I  1 PC
4  PLASTIC LEG 8 PCS	J  5.5 CM 2 PCS
5  ADJUSTABLE METAL LEG 2 PCS	K  LOVESEAT BACK 1 PC
F  3 CM 4 PCS	L  OTTOMAN 1 PC

Attention:

***Some number parts listed on the instruction sheet may not be in parts bag as they may already be assembled. Carefully check parts and packing materials prior to ordering replacements.

How to assemble:

Step 1 Secure the two individual seat frame (1 & 2) together with 2 pcs threaded rod (J)

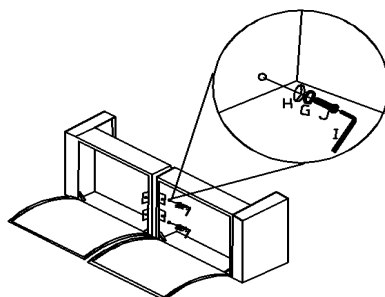

STEP 2: ATTACH THE ADJUSTABLE METAL LEG (5) AND PLACE IT ON THE UNDERSIDE OF THE SEAT BASE (1 + 2). ALIGN THE HOLES IN THE METAL LEGS (5) WITH THE HOLES IN THE SEAT BASE (1 + 2). USING THE BOLTS (F, G, H) AND ALLEN WRENCH (I) SCURE THE METAL LEG (5) TO THE SEAT BASE AND TIGHTEN ALL OF THEM FIRMLY.

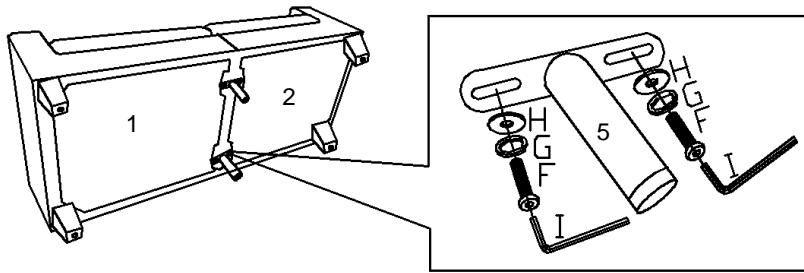

STEP 3: INSERT PLASTIC LEG (4) ONTO THE BOTTOM OF LAF & RAF SEAT BASE (1 + 2) USING THE ADJUSTABLE METAL LEG (5) TO LEVEL THE WHOLE SEAT BASE.

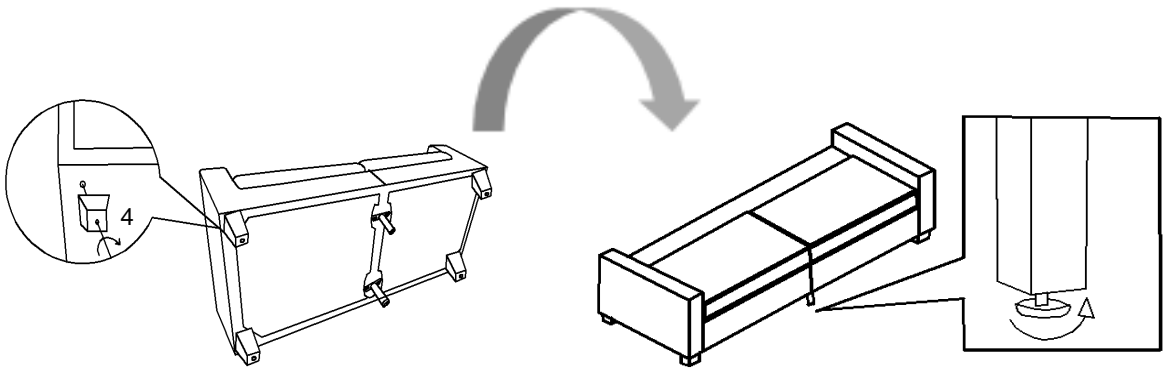

STEP 4: ALIGN FEMALE BRACKETS AT THE BACK REST (3) TO THE MALE BRACKETS AT THE SEAT BASE (1 + 2). INSERT THE BACK REST (3) TO THE SEAT BASE AND PUSH IT TO THE END. MAKE SURE THE BRACKETS IS SCURED IN POSITION.

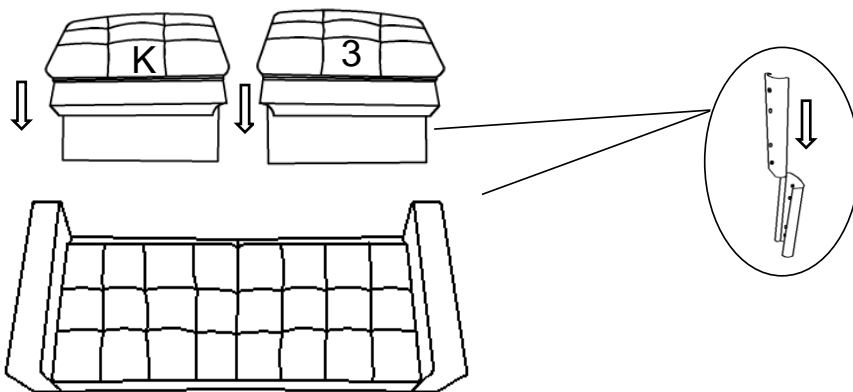

STEP 5: COMPLETED

