









ASSEMBLY INSTRUCTION ITEM NO: 39400SLAT & 39401PNL







Thank you for purchasing this quality product. Be sure to check all packing material carefully for small parts which may have come loose inside the carton during shipment. Separate, identify and count all parts and hardware. Compare with the parts list to be sure all parts are present.

"DO NOT TIGHTEN SCREWS UNTIL COMPLETELY ASSEMBLED"

IMPORTANT:

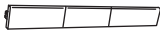
PLEASE READ INSTRUCTION BEFORE STARTING THE ASSEMBLY

HARDWARE LIST				
ITEM	DESCRIPTON	DRAWING	SIZE	QTY
A	SCREW		M4 X 32MM	8PCS
B	JCBC SCREW		M8 X 20MM	8PCS
C	JCBC SCREW		M6 X 35MM	4PCS
D	JCBC SCREW		M6 X 50MM	3PCS
E	SPRING WASHER		M6 X 13MM	3PCS
F	FLAT WASHER		M6 X 19MM	3PCS
G	L - KEY		M5 X 65MM	1PC
H	L - KEY		M4 X 65MM	1PC

PART LIST			
ITEM	DESCRIPTON	DRAWING	QTY
1	LEFT ARM		1PC
2	RIGHT ARM		1PC
3	BACK REST		1PC
4	FRONT SIDE RAIL		1PC
5	BACK SIDE RAIL		1PC
6	DAYBED SLAT	 7pcs	2 SETS
7	LEGS		4PCS

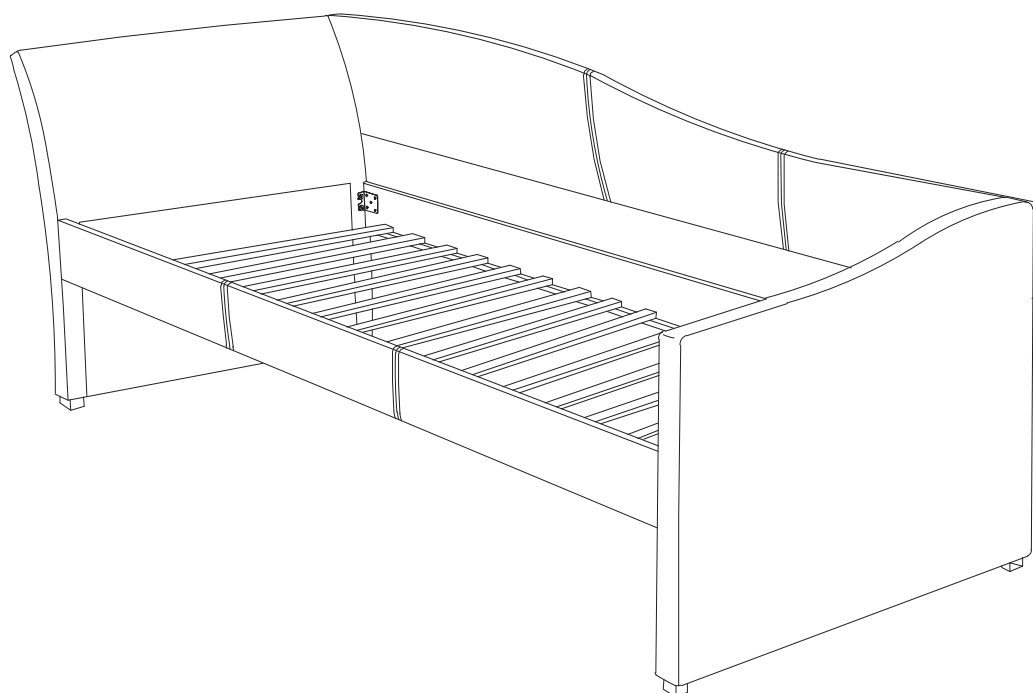

ASSEMBLY INSTRUCTION

ITEM NO : 39400SLAT & 39401PNL

STEP 1

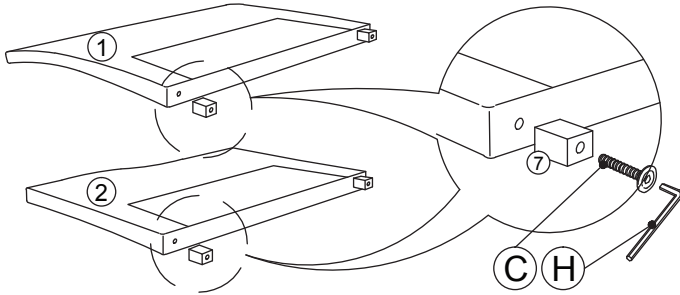

STEP 2

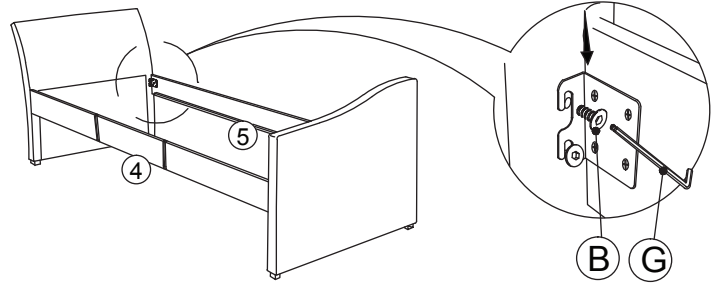

STEP 3

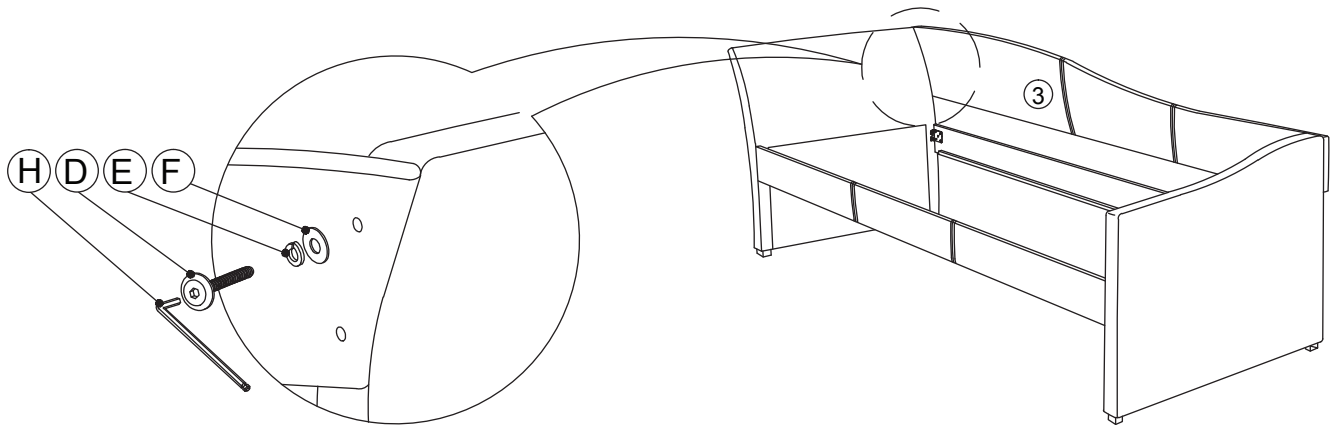

STEP 4

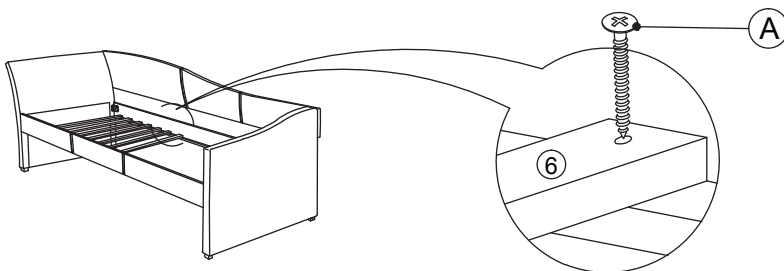

STEP 5

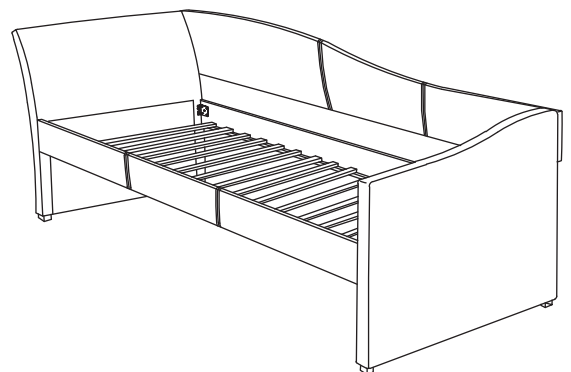

ASSEMBLY
COMPLETED





ASSEMBLY INSTRUCTION ITEM NO: 39402TRN





Thank you for purchasing this quality product. Be sure to check all packing material carefully for small parts which may have come loose inside the carton during shipment. Separate, identify and count all parts and hardware. Compare with the parts list to be sure all parts are present.

"DO NOT TIGHTEN SCREWS UNTIL COMPLETELY ASSEMBLED"

IMPORTANT:

PLEASE READ INSTRUCTION BEFORE STARTING THE ASSEMBLY

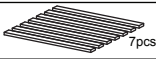
HARDWARE LIST				
ITEM	DESCRIPTON	DRAWING	SIZE	QTY
A	SCREW		M4 X 16MM	24PCS
B	SCREW		M4 X 32MM	8PCS
C	JCBC SCREW		M8 X 20MM	8PCS
D	L - KEY		M5 X 65MM	1PC

PART LIST			
ITEM	DESCRIPTON	DRAWING	QTY
1	TRUNDLE FRONT RAIL		1PC
2	TRUNDLE BACK RAIL		1PC
3	TRUNDLE SIDE RAIL		2PCS
4	TRUNDLE SLAT	 7pcs	2 SET
5	CASTOR		6PCS

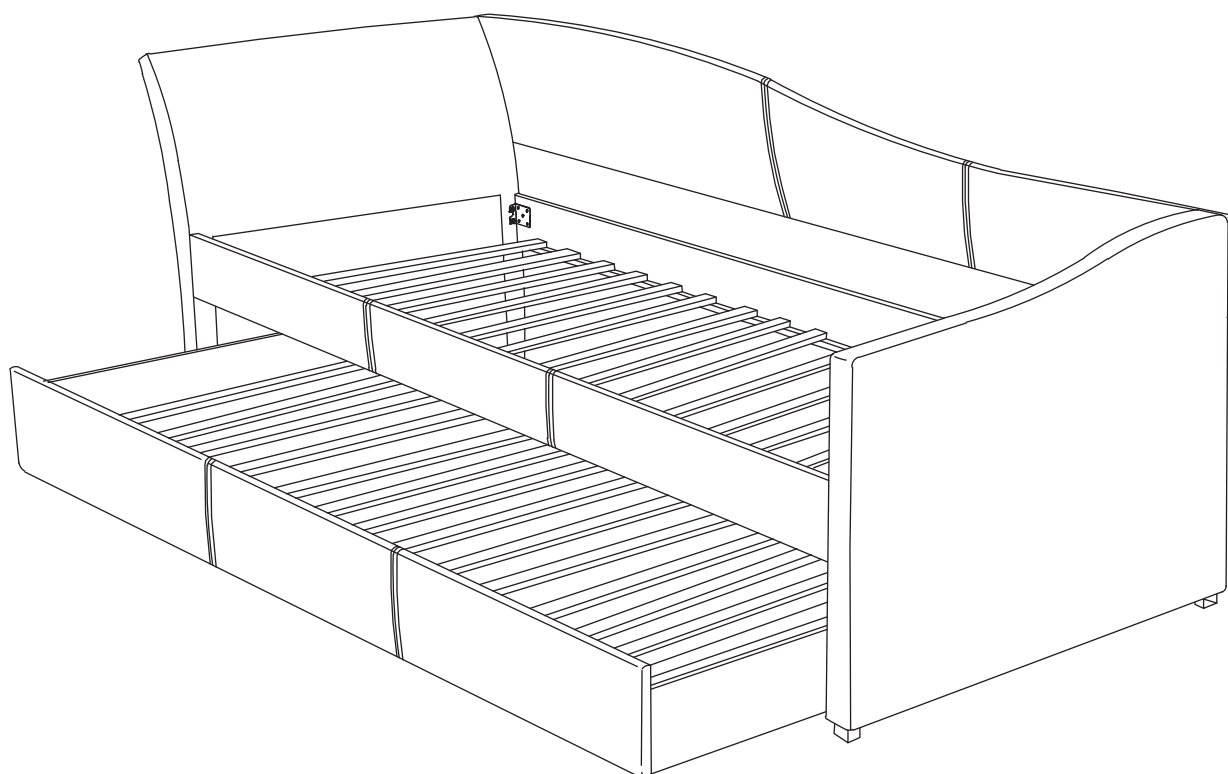

ASSEMBLY INSTRUCTION

ITEM NO : 39402TRN

STEP 1

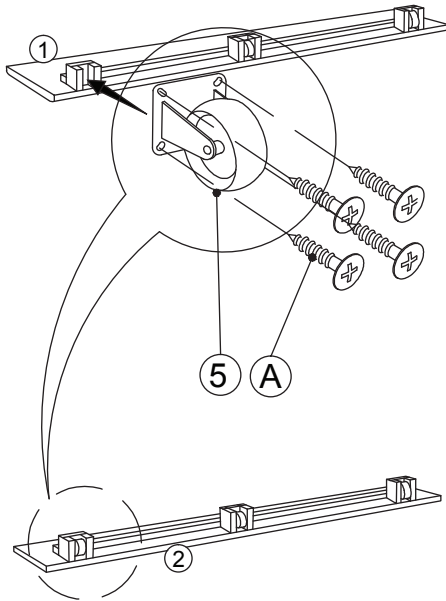

STEP 2

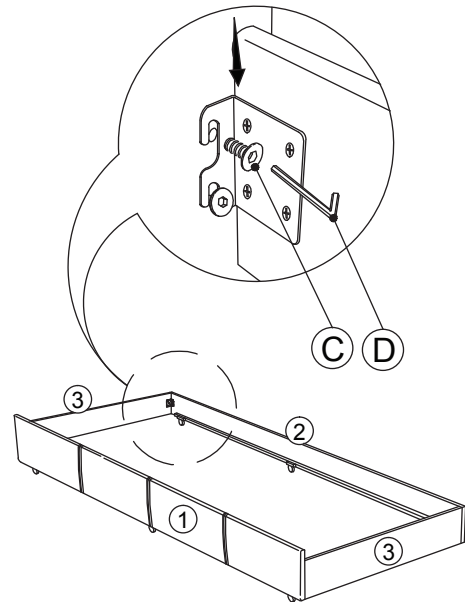

STEP 3

